

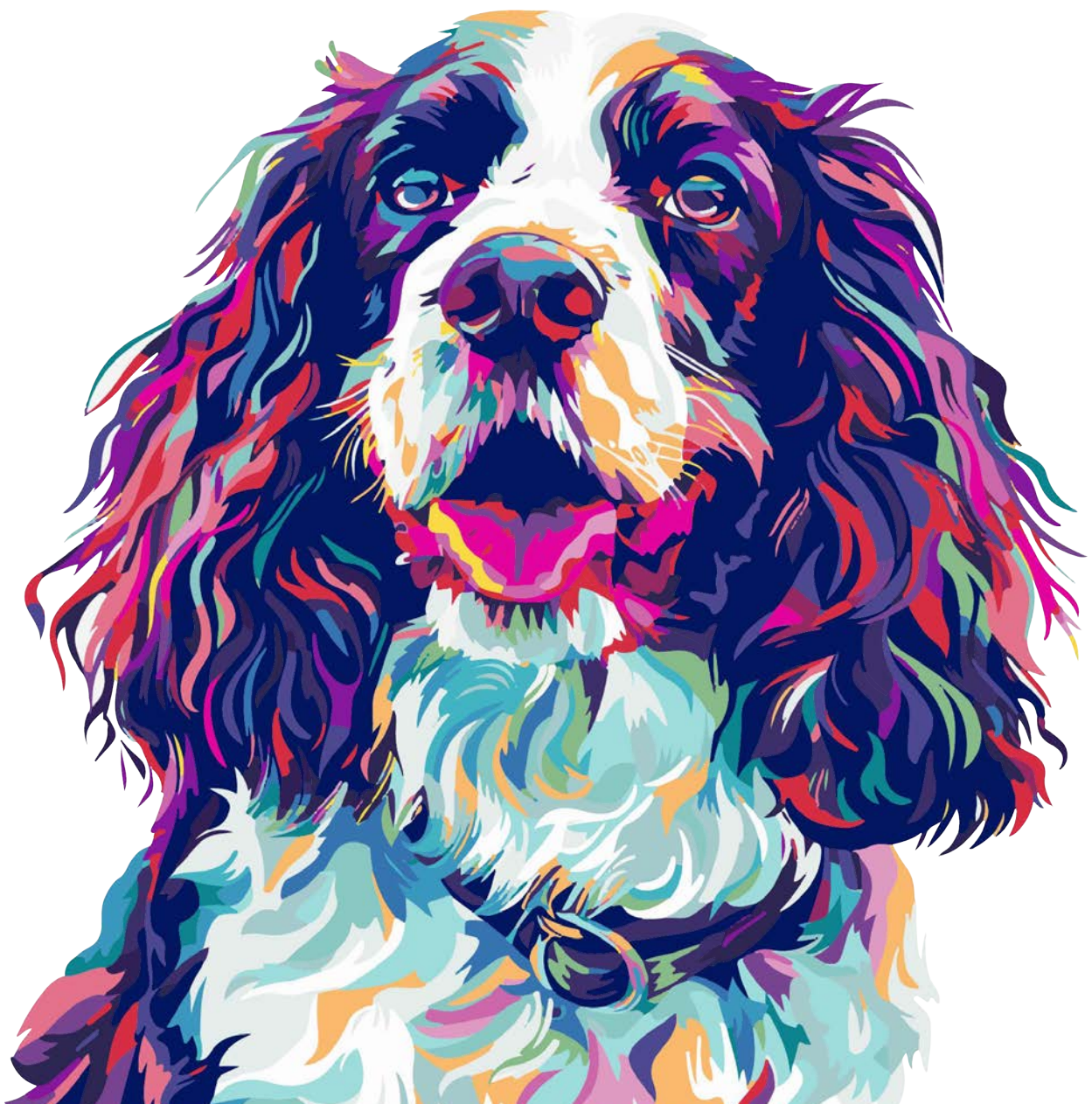

*Empowering Veterinarians to deliver the  
highest standards of patient care*

## **2024 Product Catalogue**





**Veterinary**  
Instrumentation

General Orthopaedics

Joint Surgery

Internal Fixation

External Fixation

Surgical Power Tools

Spinal Surgery

General Surgical

Soft Tissue

Ophthalmic

Dental

General Clinical

Patient Warming and Monitoring

Rehabilitation

Plate Profiles

Index

# Veterinary Instrumentation Partnership Programme

## Generate Measurable Rewards To Innovate Your Practice



Vi are continuously looking at ways to innovate and evolve our service delivery.

Through discussions with a number of veterinary professionals, many wanted to be part of a loyalty scheme but their providers did not facilitate one. Our solution? The introduction of the Vi Partnership Programme (ViPP).

Practices, through a partnership approach, are rewarded for every investment made in Vi branded products and services, with bespoke benefits delivered throughout the programme.

## What are the benefits to joining the Veterinary Instrumentation Partnership Programme?



**Additional discounts** across the entire Vi branded range



Annual **credit rebates**



**Business support meetings** with your dedicated Territory Account Manager to assist in making your practice as profitable as possible



Free **exhibition & conference** passes



Access to **training resources**, including access to our **E-Learning** platform & **Surgery Guides**

## What Next?

To discuss how the Veterinary Instrumentation Partnership Programme could benefit you and your Practice, please [email info@vetinst.com](mailto:info@vetinst.com)



# Training & Education Support Programmes

## E-Learning Platform



The Vi e-learning platform delivers a variety of veterinary educational material in an engaging and interactive format.

Whether you are a Veterinary Surgeon, a Veterinary Nurse, a Student VN or an Animal Care Auxiliary, you should find modules and content that are clinically relevant to you. With CPD certificates available, our e-learning content can help you to fulfil your annual CPD requirements, at the click of a button and from the comfort and convenience of your home or workplace. The e-learning platform also allows access to recordings of all Vi webinars, and new content is added periodically, so make sure you log in regularly to see what's new!



*Scan to register for e-learning today!*



## Practical Courses



Continuing Professional Development is one of our core company values.

Vi supported the delivery of 145 CPD courses in 2023, both within the UK and Internationally, investing over £97,000 per annum to ensure the facilitation of successful training courses and development of Veterinary healthcare professionals.



*Scan to see our CPD course calendar!*

## Webinars



Since 2021, Vi have been delivering bimonthly KOL-led webinars. These live, interactive, free-to-attend sessions continue to soar in popularity with our audience, old and new! In 2023, we welcomed more than 2600 live attendees! An attendance certificate is provided to all live attendees, so these clinically relevant and engaging sessions are the ideal way to help fulfil your annual CPD requirements.



*Scan to register for webinar updates!*



# General Orthopaedics

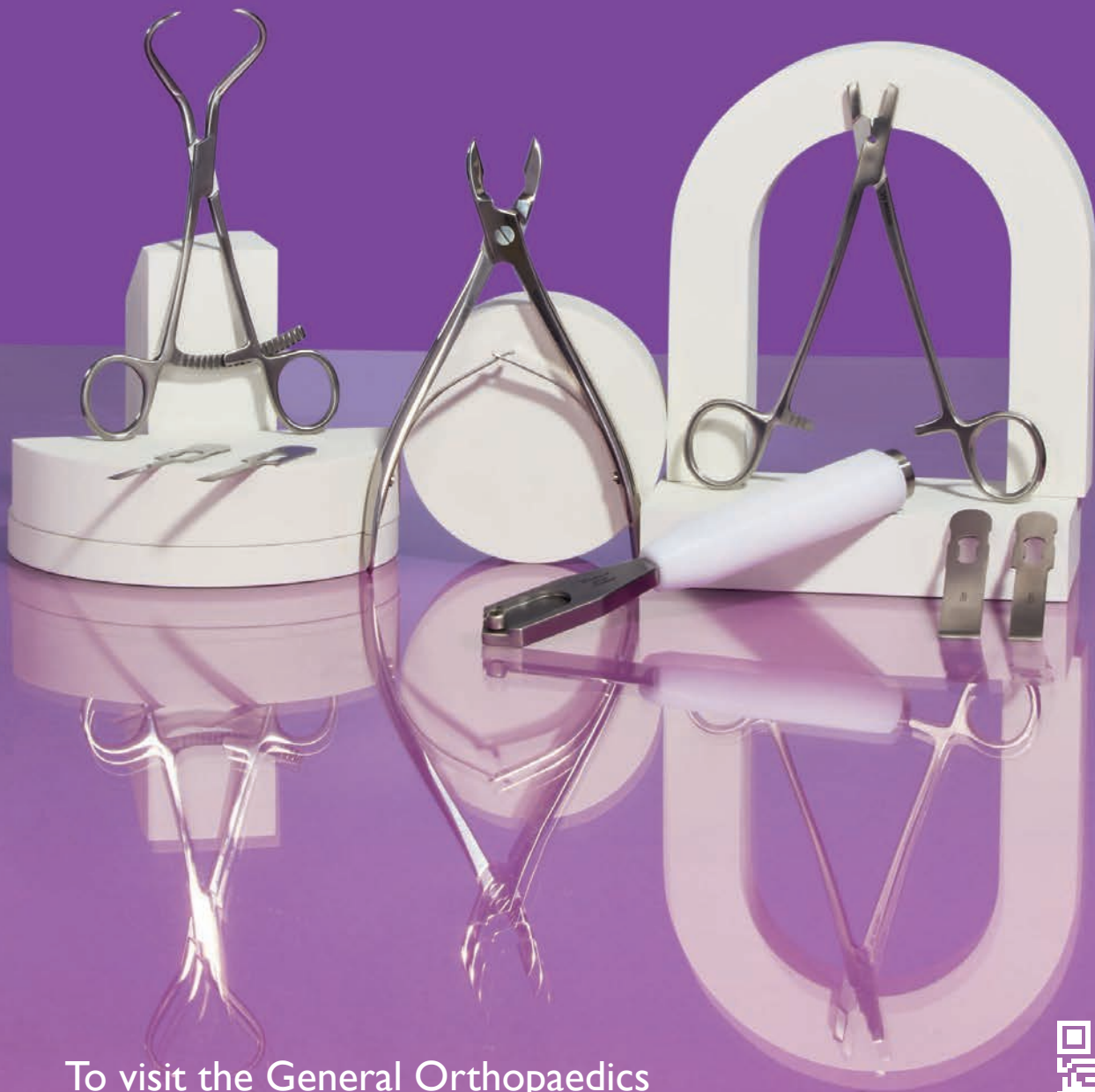

To visit the General Orthopaedics section of our website, please scan the QR code.



**Vi Orthopaedic Starter Kit - Standard**



**The Standard Kit contents:**

001000	Adjustable Bone Saw With 5 Blades	x1	090003	Bone Pin Trochar 7/64 2.8mm Diam 300mm Long	x1
001004	Orthopaedic Stainless Steel Hard Back Saw 0.4mm Cut	x1	090004	Bone Pin Trochar 1/8 3.2mm Diam 300mm Long	x1
001010	Excision Arthroplasty Rasp	x1	090005	Bone Pin Trochar (9/64) Ø3.50mm x 300mm Long	x1
001048	Mini Hohman Retractor 8mm Short Tip	x1	090006	Bone Pin Trochar 5/32 4.0mm Diam 300mm Long	x1
001090	Disarticulator Small	x1	090007	Bone Pin Trochar 3/16" 4.8mm Diam 300mm Long	x1
001116	Meniscus Surgery Kit	x1	090008	Bone Pin Trochar 1/4 6.35mm Diam 300mm Long	x1
001221	Standard Jacobs Chuck & Handle 1/4" (6mm) Capacity	x1	090021ART	1.1mm Arthrodesis Wire 125mm Long (Pack of 10)	x1
001234	Implant Cutter S/Steel Cuts To 4.0mm (370mm Long) TC Inserts	x1	090022ART	1.6mm Arthrodesis Wire 125mm Long (Pack of 10)	x1
001237/1	Implant Cutter S/Steel Simple Action 2.0mm Max (255mm Long)	x1	090023ART	2.0mm Arthrodesis Wire 125mm Long (Pack of 10)	x1
001250	Wire Passer Double Ended (145mm)	x1	090024ART	1.4mm Arthrodesis Wire 125mm Long (Pack of 10)	x1
001260	Wire Twister & Shear Cutter (165mm)	x1	090038	Bone Pin Roll	x1
001271	Periosteal Elevator CVD AO Type 180mm 6mm End PTFE Handle	x1	090039E	K/A Wire Storage Tube & Dispenser 125mm 0.9/1.1/1.6/2.0	x1
001300	Small Curved Rongeurs 4mm Bite	x1	091151	CCL Kit - Crimpers H/Duty Needleholders & 2 of Each Nylon	x1
001310	Small Angled Cutter (15mm Blade)	x1	623850	15mm Osteotome Swedish Pattern (205mm)	x1
001320	Mallet 300g	x1	782600	Volkman Scoop Double Ended 4mm & 6mm (200mm Long)	x1
001362	Kirschner & Arthrodesis Wire Bender 140mm	x1	H090104	2.7mm Round Shank Drill Hard	x1
001600	Variable Speed Orthopaedic Drill Kit	x1	H090106S	3.5mm Round Shank Drill Hard	x1
090000	Bone Pin Trochar 1/16 1.6mm Diam 300mm Long	x1	OW0810	Reel of Orthopaedic Wire 0.8mm/21g Diameter	x1
090001	Bone Pin Trochar 5/64 2.0mm Diam 300mm Long	x1	OW1010	Reel of Orthopaedic Wire 1.0mm/20g Diameter	x1
090002	Bone Pin Trochar 3/32 2.4mm Diam 300mm Long	x1	XRAYMARKI	Left And Right Hand X-Ray Markers	x1

**ORTHOKITI** Vi Orthopaedic Starter Kit  
**ORTHOKITINP** Vi Orthopaedic Starter Kit Standard - No Power Tools



## Vi Orthopaedic Starter Kit - Enhanced



### The Enhanced Kit contents:

001000	Adjustable Bone Saw With 5 Blades	x1	090021ART	1.1mm Arthrodesis Wire 125mm Long (Pack of 10)	x1
001004	Orthopaedic Stainless Steel Hard Back Saw 0.4mm Cut	x1	090022ART	1.6mm Arthrodesis Wire 125mm Long (Pack of 10)	x1
001010	Excision Arthroplasty Rasp	x1	090023ART	2.0mm Arthrodesis Wire 125mm Long (Pack of 10)	x1
001021	Universal Sulcoplasty Rasp 210mm Long	x1	090024ART	1.4mm Arthrodesis Wire 125mm Long (Pack of 10)	x1
001041	Hohman Retractor 18mm Short Narrow Tip	x2	090039E	K/A Wire Storage Tube & Dispenser 125mm 0.9/1.1/1.6/2.0mm	x1
001042	Hohman Retractor 12mm Short Narrow Tip	x2	623850	15mm Osteotome Swedish Pattern (205mm)	x1
00109SET	Hatt Spoon Set (Set Of 3)	x1	782600	Volkman Scoop Double Ended 4mm & 6mm (200mm Long)	x1
001117	Meniscus Surgery Set - Enhanced	x1	AR-17-02	Stifle Lever PTFE Handle 280mm VSTL	x1
001221	Standard Jacobs Chuck & Handle 1/4" (6mm) Capacity	x1	H090102	2.0mm Round Shank Drill Hard	x1
001234	Implant Cutter S/Steel Cuts To 4.0mm (370mm Long) TC Inserts	x1	H090104	2.7mm Round Shank Drill Hard	x1
001237/1	Implant Cutter S/Steel Simple Action 2.0mm Max (255mm Long)	x1	H090106S	3.5mm Round Shank Drill Hard	x1
001250	Wire Passer Double Ended (145mm)	x1	H090112	2.5mm Round Shank Drill Hard	x1
001260	Wire Twister & Shear Cutter (165mm)	x1	HIPTOGKITLF	LigaFiba 3.0mm Tog Introducer 3.5 & 4.5mm Drills & Guide	x1
001271	Periosteal Elevator CVD AO Type 180mm 6mm End PTFE Handle	x1	IMPBOXTRO	IM Pin Box Complete With Steinman Pins Trochar Tips 30 Total	x1
001300	Small Curved Rongeurs 4mm Bite	x1	LFLSCRSTARTER	LigaFiba Lateral Suture + Crimp Starter Kit	x1
001310	Small Angled Cutter (15mm Blade)	x1	OW0710	Reel of Orthopaedic Wire 0.71mm/ 22g Diameter	x1
001311	Large Angled Cutters 19Mmm Blade 23cm Long	x1	OW0810	Reel of Orthopaedic Wire 0.8mm/ 21g Diameter	x1
001320	Mallet 300g	x1	OW0910	Reel of Orthopaedic Wire 0.9mm/ 20.5g Diameter	x1
001323	TTA Mallet 140g	x1	OW1010	Reel of Orthopaedic Wire 1.0mm/ 20g Diameter	x2
001343	10mm Osteotome Light (140mm)	x1	SAP2.5	Suture Anchor Pin 2.5mm Diameter 1.0mm Hole	x1
001362	Kirschner & Arthrodesis Wire Bender 140mm	x1	SAP3	Suture Anchor Pin 3mm Diameter 1.0mm Hole	x1
001363	Stubby Punch 50mm	x1	SAP4	Suture Anchor Pin 4mm Diameter 2.0mm Hole	x1
001380	Modular Osteotome With Seven Blades - 4,6,8,10,12,15 & 20mm	x1	XRAYMARKI	Left And Right Hand X-Ray Markers	x2

### ORTHOKITWOW Vi Orthopaedic Starter Kit Enhanced With Battery Power

Contains list above plus Black Series equipment:

BLACKKIT	Vi Black Series Drill W/ Saw Set	x1
BLACKSW451207B	Vi Black Saw Blade 45mm x 12mm Thick 0.7mm Set 0.95mm	x1
BLACKSW451607B	Vi Black Saw Blade 45mm x 16mm Thick 0.7mm Set 0.95mm	x1

### ORTHOKITWONP Vi Orthopaedic Starter Kit Enhanced (No Power Tools)

Contains list above but does not include power tools.

## Fragment Forceps

### Pointed Reduction Forceps

Ideal for fragment reduction, these forceps gently hold fragments in position whilst permanent fixation is being applied. Particularly useful in the repair of fractures of the distal femur, acetabulum & distal tibia.

The smaller sizes are useful in the repair of the long bones of the miniature dog & cat as well as the smaller bones of the distal limbs in larger patients.

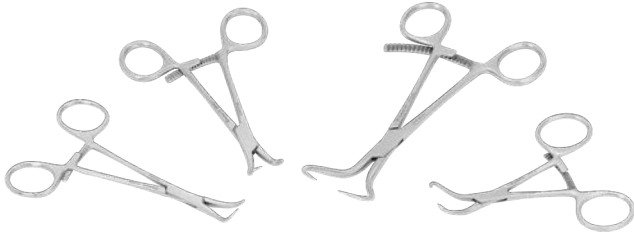

- 001200** Fragment Forceps 160mm Long
- 001201** Small Fragment Forceps 135mm Long
- 001208** Very Small Fragment Forceps 100mm Long
- 001208M** Miniature Fragment Forceps 135mm Long
- 001200SET** Fragment Forceps Set of 4 (As above)

### Pointed Reduction Forceps With Spinlock



Useful for delicate reduction of fragments. Initial reduction is performed with the spinlock flipped out, to give maximum control. Once placed, the spinlock is flipped back in & gently tightened.

- 001200SL** Pointed Reduction Forceps With Spinlock 180mm Long
- 001201SL** Small Fragment Forceps With Spinlock 135mm Long
- 001245SL** Large Fragment Forceps With Spinlock 180mm Long

### Very Large Fragment Forceps



Use where a wide gape is required or where the instrument needs to be further out of the surgical field. Spinlock version is very useful during CrCl surgery for repositioning the stifle prior to placement of a lateral suture, or holding osteotomies during closing wedge type procedures.

- 001202** Very Large Fragment Forceps 205mm Long
- 001203** Very Large Fragment Forceps With Spinlock 215mm Long

## Reduction Forceps With Hard Wire Guide



Standard pattern fragment forceps with an added wire guide, to allow placement of a temporary or permanent wire as close as possible to the point of reduction.

Guide capacity up to 1.6mm

- 001201W** Reduction Forceps With Wire Guide 140mm Long Gape 10-25mm
- 001200W** Reduction Forceps With Wire Guide 170mm Long Gape 15-40mm
- 001202W** Reduction Forceps With Wire Guide 200mm Long Gape 25-65mm

## Twin Point Fragment Forceps



Twin point fragment forceps hold securely while allowing placement of implants such as screws at the point of maximum reduction between the points.

Particularly useful for humeral condyle repairs, & repairs in the small bones distal to the carpus & tarsus.

- 001205** Twin Point Fragment Forceps Straight 170mm Long
- 001206** Twin Point Fragment Forceps Curved 165mm Long

## Ikuta Bone Clamps

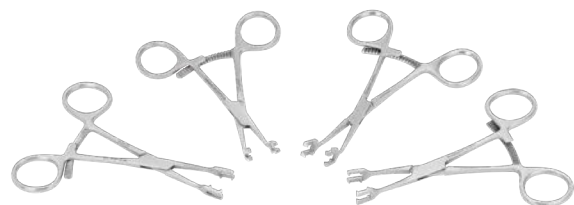

Ikuta slotted clamps are designed to allow the passage of wires or screws at the point of maximum pressure. For bones up to 20mm diameter. The smaller sizes are for wires, the larger for small screws. Consider Twin Point Fragment Forceps above for larger screws, or a 001219 Long Ratchet Schroeder, a vusellum forcep, for more spring.

- 001207A** Straight For Wires To 2.0mm 125mm Long
- 001207B** Curved For Wires To 2.0mm 125mm Long
- 001207C** Straight For Screws & Wires To 3.0mm 125mm Long
- 001207D** Curved For Screws & Wires To 3.0mm 125mm Long
- 001207SET** Ikuta Bone Forceps Set of 4 (As above)

### Long Ratchet Schroeder Tenaculum



A larger, springier version of the straight Twin Point Forceps. Useful for reduction of small fragments prior to drilling & screwing. Longer ratchet than a standard Schroeder increases usefulness.

001219 Long Ratchet Schroeder Tenaculum Str 240mm Long

### Large Twin Point Reduction Forceps With Spinlock



Accessing the point of maximum compression to insert a screw is made easier by the use of twin point forceps. This size is useful for most elbows where accuracy of placement is essential, including Spaniels which are most likely to be affected by IOHC/HIF.

001204 Twin Point Reduction Forceps With Spinlock 215mm Long

### Bone Holding Forceps

There is no universal bone holder. Both the dimensions of the bones involved & the degree of force needed to manipulate or clamp the bone vary immensely. Select the most appropriate forcep for the procedure.

### Vi Bone Holding Forceps



Useful general purpose bone holder for maintaining reduction during I/M pinning. Can also be used during plating procedures, passing drills & screws through the jaw centre.

001210 Bone Holding Forceps 155mm Long

### Reduction Forceps Serrated Jaws



These reduction forceps have serrated jaws & spinlock which provides secure incremental control.

001217 Reduction Forceps Serrated Jaws Spinlock 190mm Long  
001217/L Reduction Forceps Serrated Jaws Spinlock 240mm Long

### Small Serrated Bone Holding Forceps



Manipulation of the long bones of cats & small dogs is difficult without crushing. The serrated jaws of this forcep are contoured to maximise grip & support. The tips are sharp. They may be used as small fragment forceps.

001218XS X Small Serrated Bone Holding Forceps 3mm Grasp 140mm  
001218S X Small Serrated Bone Holding Forceps 5mm Grasp 140mm  
001218 Small Serrated Bone Holding Forceps 7mm Grasp 140mm  
001218L Large Serrated Bone Holding Forceps Ratchet 12mm Grasp 180mm  
001218SET Serrated Bone Holding Forceps Set of 4 (As above)  
001218LG Small Serrated Bone Holding Forceps Spinlock 12mm Grasp 180mm

### Small Curved Serrated Reduction Forceps



A nice forcep for the manipulation of small bones or small bone fragments.

001996 Small Curved Serrated Reduction Forceps 145mm Long

### Dingmans Forceps



Useful for manipulation of bone fragments.

001470 Dingmans Forceps Long Ratchet 215mm Long

### Lowman Bone Clamp Veterinary Pattern Small Dog/Cat Size



Re-worked traditional human clamp, in sizes suitable for cats & small dogs:

- Lightweight
- Requires minimal exposure
- Use to reduce oblique fractures
- Secures plate to fracture prior to screw placement

- 001991 Lowman Bone Clamp Veterinary Pattern 60mm Long
- 001993 Lowman Bone Clamp Large 220mm Long

### Kern Bone Holding Forceps



Kerns give a very firm controllable grip, aiding manipulation & reduction of fragments. A quick release ratchet locks the jaws. Useful in general orthopaedics & for surgery around the hip, in particular:

- Femoral shaft fractures
- Triple pelvic osteotomy
- Hip toggle
- Fractures of the acetabulum

- 001216 Kern Bone Holding Forceps Mini 4.75" 125mm Long
- 001213 Kern Bone Holding Forceps Small 6.75" 170mm Long
- 001214 Kern Bone Holding Forceps Large 8.5" 215mm Long
- 001213SET Kern Bone Holding Forceps Set of 3 (As above)

### Self Centering Bone Holding Forceps



Some fracture reductions require that the bone forceps jaws be angled from the handles. Such forceps require:

1. A sophisticated hinge mechanism to allow the jaws to maintain alignment as they open & close.
2. A special locking device which can cope with the laxity at the hinge.

The spinlock & the special jaw make the instrument very nice to use but very expensive.

The veterinary pattern stands up from the bone in use, where the human pattern sits down & falls away which is generally less appropriate in veterinary patients.

- 001209 Self Centering Bone Holding Forceps Very Small 150mm Long
- 001211 Self Centering Bone Holding Forceps Small 190mm Long
- 001212 Self Centering Bone Holding Forceps Large 240mm Long
- 001209V Self Centering Bone Holding Forceps Very Small 150mm Vet Pattern
- 001211V Self Centering Forceps Bone Holding Small 190mm Vet Pattern
- 001212V Self Centering Forceps Bone Holding Large 240mm Vet Pattern

### Plate Holding/Drill Guide Forceps

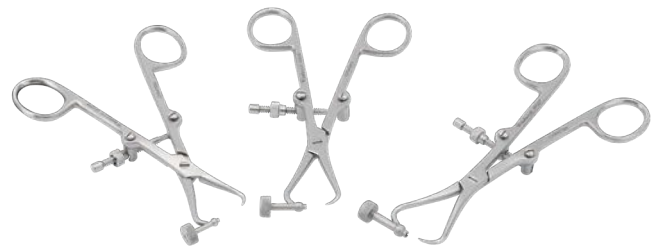

Combination bone holder & drill guide. Allows temporary fixation of the plate to the bone whilst a hole is drilled. The ball shape of the tip engages the plate hole, while the tip of the drill guide engages the bone. Tips are offset slightly to avoid the drill bit hitting the opposite bone holder tip.

- 001225 1.5mm/2.0mm Plate Holding/Drill Guide Forceps 140mm Long
- 001226 2.4mm/2.7mm Plate Holding/Drill Guide Forceps 145mm Long
- 001227 3.5mm Plate Holding/Drill Guide Forceps 150mm Long
- 0012SET Plate Holding/Drill Guide Forceps Set of 3 (As above)

### Plate Holding Forceps



Use to hold a plate in position on the bone. Ball tips engage the plate holes. Also useful as a fragment forcep in young, soft bone, as the balls prevent over penetration.

001215 Plate Holding Forceps 160mm Long

### Left Handed Fragment Forceps



Left handed fragment forceps are modified specifically to make use easier. One black handle identifies left handed instruments.

- 001201SL-L Small Fragment Forceps With Spinlock - 135mm Left Handed
- 001203-L Very Large Fragment Forceps With Spinlock - 210mm Left Handed



## Training & Education

Our **e-learning platform** delivers a variety of technical and clinical educational material, in an engaging and interactive format.

With a CPD certificate awarded upon successful completion of each module, the e-learning platform from Vi will help you to fulfil your annual CPD requirements.

Sign up today by scanning the QR code below.



## Rongeurs

Rongeurs vary with respect to bite size and jaw angle. Where a rongeur has a specific function, it is indicated in the description.

### Simple Action Rongeurs

Typically simple action rongeurs offer a wide bite but rely on the physical strength of the surgeon. Most small rongeurs have a simple action.

### Vi Small Curved Rongeurs



A good general purpose rongeur for small bone nibbling procedures, e.g. excision arthroplasty, arthrodesis, sequestrum removal.

001300 Small Curved Rongeur 4mm Bite 170mm Long

### Mini-Friedman



Useful in bulla osteotomy.

142501 Mini-Friedman Rongeur Curved 3mm Bite 160mm Long

### Micro-Friedman



A small spine rongeur.

142502 Micro-Friedman Rongeur Curved 2.2mm Bite 155mm Long

### Lempert Straight



Useful for spines and bulla osteotomy.

6730/10 Lempert Rongeurs Straight 3mm Bite 190mm Long

### Compound Action Rongeurs

The compound action give a mechanical advantage to the surgeon but reduces the bite width.

#### Jansen



Compound action, powerful but small bite.

142200 Jansen Rongeur Curved 4mm Bite 190mm Long

#### Ruskin



A heavy duty compound action rongeur.

142270 Ruskin (Liston) Rongeur Compound Action Curved 6mm Bite 230mm Long

#### Stille-Luer



A very large rongeur.

142305 Stille-Luer Heavy Compound Action Curved 8mm Bite 225mm

## Duck-Billed Daniel Rongeurs



Designed by Simon Wheeler BVSc PhD, these Rongeurs can remove full thickness laminal bone in small dogs.

They are, however, best used to remove the layer of deep cortical bone overlying the spinal cord once the superficial cortex & cancellous bone have been removed using power tools; this is particularly true of the medium & large dog.

**001400** Duck-Billed Daniel Rongeurs 3mm Bite 177mm Long

## Micro Spine Rongeur Set

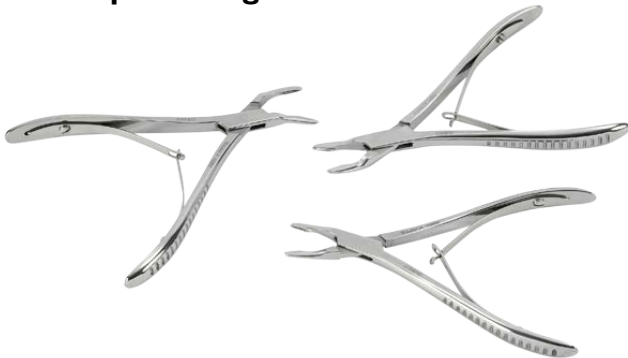

Very fine Rongeurs with a 1.75mm (width) bite. Set contains three variations: straight, curved & angled.

**142600** Micro Spine Rongeurs Set of 3

## Daniel Rongeur



The jaws of this instrument are straight & the bite is small. Also suitable for bulla osteotomy.

**001402** 4mm Daniels Rongeurs 130mm Cvd

## Compound Action Spinal Rongeurs



Much more powerful than the Daniels, this instrument can nibble through full thickness lamina. The jaws are very fine & angled to allow the surgeon to enlarge the inter-vertebral foramen.

Available in 2mm, 3mm, & 4mm jaw widths. Length 190mm.

**001429** Compound Action Spinal Rongeurs 2mm

**001430** Compound Action Spinal Rongeurs 3mm

**001431** Compound Action Spinal Rongeurs 4mm

## Smith-Kerrison Punch Forceps



This is a traditional design with a 40 degree upward cutting jaw. Robust spine forceps. 185mm shaft.

**001445** Smith-Kerrison Punch Forceps 2mm

**001446** Smith-Kerrison Punch Forceps 3mm

## 40 Degree Bone Punch Forceps - Low Profile



Designed for use where a high speed bur has removed the outer cortical layer and the underlying cancellous layer, the powerful nibbling action of this device allows very controlled removal of the final layer of cortical bone. The wedge-shaped foot of this device is designed to allow good access whilst still retaining strength, and is polished to minimise friction and potential trauma. Overall length 21cm.

**001438** Batemans Spine Punch 40 Degree Upward Cut 2mm

**001439** Batemans Spine Punch 40 Degree Upward Cut 3mm

**001441** Batemans Spine Punch 40 Degree Upward Cut 4mm

## Bone Cutters

### Small Angled Cutters

A very useful small cutter. The jaw is angled to allow cutting where access is restricted, e.g. excision arthroplasty in cats & small dogs & tibial crest transposition. The design allows for transection of the tibial crest while retaining distal periosteal attachments. Also useful for articular cartilage removal in arthrodesis, digit & tail amputations.



001310 Small Angled Cutter 15mm Blade 170mm Long

### Large Angled Cutters



Similar style to the Small Angled Cutters, but more powerful & more robust due to their size. The simple action allows a wider jaw opening. The angled jaws, more slender than similar sized Liston's, serves to further improve visibility & access into tight spots. The notch in the jaws serves to improve visibility further & make accurate cuts more achievable.

001311 Large Angled Cutters 19mm Jaw 230mm Long

### Liston



A widely used bone cutter with straight & angled jaw options.

- 141700 Liston Bone Cutters 25mm Blade Str 140mm Long
- 141710 Liston Bone Cutters 20mm Blade Aof 140mm Long
- 141730 Liston Bone Cutters 25mm Blade Str 170mm Long
- 141740 Liston Bone Cutters 25mm Blade Aof 190mm Long
- 141745 Liston Bone Cutters 30mm Blade Str 220mm Long
- 141755 Liston Bone Cutters 30mm Blade Str 190mm Long
- 141764 Liston Bone Cutters 30mm Blade Aof 200mm Long

## Compound Action Bone Cutters

All three following designs are similar but vary according to size of bite.

### McIndoe



Compound jointed action gives power but reduces bite size.

141900 McIndoe Bone Cutter 15mm Blade Aof 170mm Long

### Ruskin



Similar in design to McIndoe but larger.

- 141940 Ruskin (Liston) 25mm Blade Str 190mm Long
- 141960 Ruskin (Liston) 25mm Blade Aof 190mm Long

### Horsley



Heavy duty compound action cutters.

- 141660 Horsley Cutter 35mm Blade Aof 260mm Long
- 141660S Horsley Cutter 35mm Blade Str 260mm Long



## Periosteal Elevators

### Periosteal Elevator/Bone Lever



One end of this instrument is bent for use as a hook for retrieving & manipulating bone fragments. The other end is a periosteal elevator useful for clearing soft tissue from bone prior to plating, drilling or burring.

001270 Periosteal Elevator/ Bone Lever 4mm/7mm Tips 195mm

### Freer Periosteal Elevator



The Freer Elevator is a fine instrument which is particularly useful in spinal work.

7350/05 Freer Periosteal Elevator 5mm 180mm Long

### Howarth Dissector (Modified)



Developed by Richard Whitelock specifically to clear soft tissues from the proximal tibia in the TPLO procedure. It is also useful as a general purpose periosteal elevator. One end acts as a curved periosteal elevator & the other end is straight.

001273 Howarth Dissector (Modified) 225mm Long

### AO Type Periosteal Elevator



The AO type instrument is the archetypal 'periosteal elevator'. Available in curved and square 6mm tip.

001271 AO Type Periosteal Elevator PTFE Handle Curved Tip 6mm 180mm

001274 AO Type Periosteal Elevator PTFE Handle Square Tip 6mm 190mm

### Periosteal Elevator Very Fine



001272 Periosteal Elevator Very Fine 2mm/3mm 180mm Long

### Molt Periosteal Elevator



The Molt is a double ended Periosteal Elevator. The tips are round & dished. 4mm & 6mm diameters.

001275 Molt Periosteal Elevator 200mm

### MIPO Minimally Invasive Plate Osteosynthesis Elevator



This instrument is not so much a periosteal elevator, more a dissecting probe to clear a tunnel under muscle layers for the plate. The periosteum is, in fact, left intact.

001276 MIPO Elevator 280mm Long

### K/A Wire/Small Pin Punch



The cut ends of K wires, arthrodesis wires & small pins used for fragment fixation e.g. distal femoral fractures, should be buried beneath the bone or articular surface to minimise soft tissue irritation. The tip of the punch is concave to locate onto the pin end. The other end is struck with a mallet.

- 001360 K/A Wire & Small Pin Punch 135mm Long
- 001361 K/A Wire & Very Small Pin Punch 1.6mm Tip 135mm Long

### IM Pin Punch



IM Pin Punch with a larger diameter tip (6mm) for driving larger pins.

- 001374 IM Pin Punch 135mm Long 6mm Tip

### 'Stubby' Punch



The reduced working length allows the stubby punch to be held between thumb & forefinger much closer to the patient for increased control. This is especially useful when working without an assistant. 50mm long.

- 001363 'Stubby' Punch 50mm Long

### K Wire Bender



Used to bend K & A wires prior to rotation & seating onto the bone. This instrument is designed to slip over the wire concentrating all the bending forces at the pin/bone interface. The instrument is double ended, the small end is for 0.9mm & 1.1mm wires, the large end is for 1.4mm, 1.6mm & 2.0mm wires.

- 001362 K Wire/Small Pin Bender 140mm Long

### Offset Wire Bender



A robust design for the accurate & reliable creation of bends close to the bone surface. The three cannulations (1.1mm, 1.6mm & 2.0mm) cater for the full range of our arthrodesis wires. The short length of each cannulation makes these easy to clean.

- 001373 Offset Wire Bender

### Offset K/A Wire Punch For Bent Pins



The bigger, angled foot of this punch is designed to allow bent-over arthrodesis or K wires to be driven home onto the bone surface. May also be used for Rush pins.

- 001364 Offset K/A Wire Punch For Bent Pins 135mm Long

### Orthopaedic Hard Back Saw



Made from stainless steel. The stiff back helps to guide the saw.

- 001004 Orthopaedic Hard Back Saw

### Adjustable Bone Saw



Useful for completing/squaring off the osteotomy, this saw comes complete with five, fine chrome plated blades. Blade length is adjustable from 40mm to 100mm. Handle length 130mm. Blade length 155mm.

- 001000 Adjustable Bone Saw c/w 5 Fine Blades
- 001001-A Spare Fine Blades Pk of 5 Chrome Plated
- 001000SS-A Adjustable Saw Blade Single Sterile
- 001002 Coarse Stainless Blade 140mm Long

### Patella Saw



With standard sawblade including Allen Wrench 1.5mm.

- LE123100590 Patella Saw
- LE123100520 Patella Saw Replacement Blade
- LE123100521 Patella Saw Allen Wrench

## Osteotomes

### Modular Osteotome With Ultra-Thin Interchangeable Blades & Diamond Rasp



PTFE osteotome handle which accepts a good range of blades plus a diamond rasp (not included in set). Blades are very thin (1.1mm) allowing fine cuts & reducing the incidence of breaking the block during block sulcoplasty procedures.

Replacement T wrench & retaining screw are also available.

<b>001380</b>	Modular Osteotome With 7 Blades
<b>001382</b>	Modular Osteotome Replacement Blade 4mm
<b>001390</b>	Modular Osteotome Replacement Blade 5mm
<b>001383</b>	Modular Osteotome Replacement Blade 6mm
<b>001384</b>	Modular Osteotome Replacement Blade 8mm
<b>001385</b>	Modular Osteotome Replacement Blade 10mm
<b>001386</b>	Modular Osteotome Replacement Blade 12mm
<b>001387</b>	Modular Osteotome Replacement Blade 15mm
<b>001388</b>	Modular Osteotome Replacement Blade 20mm
<b>001389</b>	Modular Diamond Rasp 6mm
<b>TBHEX40</b>	4.0mm T Bar Hex Driver
<b>001380SCREW</b>	Spare Screw For Modular Osteotome Handle

## Osteotomes - Swedish Pattern



Use an osteotome to make a precise elective cut, e.g. trochanteric osteotomy, excision arthroplasty.

<b>623880</b>	Osteotome Swedish 30mm 205mm Long
<b>623870</b>	Osteotome Swedish 25mm 205mm Long
<b>623860</b>	Osteotome Swedish 20mm 205mm Long
<b>623850</b>	Osteotome Swedish 15mm 205mm Long
<b>623840</b>	Osteotome Swedish 12mm 205mm Long

## Osteotomes - Light Pattern



Use an osteotome to make a precise elective cut, e.g. trochanteric osteotomy, excision arthroplasty.

<b>001341</b>	Osteotome Light 15mm 140mm Long
<b>001342</b>	Osteotome Light 12mm 140mm Long
<b>001343</b>	Osteotome Light 10mm 140mm Long
<b>001344</b>	Osteotome Light 8mm 140mm Long
<b>001345</b>	Osteotome Light 6mm 140mm Long
<b>001346</b>	Osteotome Light 4mm 140mm Long

## 'Stubby' Osteotome



Available from 3mm to 14mm & as a set. 70mm long.

<b>001366</b>	'Stubby' Osteotome 3mm 70mm Long
<b>001367</b>	'Stubby' Osteotome 4mm 70mm Long
<b>001368</b>	'Stubby' Osteotome 6mm 70mm Long
<b>001369</b>	'Stubby' Osteotome 8mm 70mm Long
<b>001370</b>	'Stubby' Osteotome 10mm 70mm Long
<b>001371</b>	'Stubby' Osteotome 12mm 70mm Long
<b>001372</b>	'Stubby' Osteotome 14mm 70mm Long
<b>0013SET</b>	'Stubby' Osteotome Set of 7 (As above)

## Chisels

### Chisels Swedish Pattern



Use a chisel where heavier bone removal is required, e.g. sequestrum removal.

- 162340** Chisel Swedish Pattern 12mm 205mm Long
- 162350** Chisel Swedish Pattern 15mm 205mm Long
- 162360** Chisel Swedish Pattern 20mm 205mm Long

### Chisels Light Pattern



Use a chisel where heavier bone removal is required, e.g. sequestrum removal.

- 001350** Chisel 12mm 140mm Long
- 001351** Chisel 10mm 140mm Long
- 001352** Chisel 8mm 140mm Long
- 001353** Chisel 6mm 140mm Long
- 001354** Chisel 4mm 140mm Long

## Gouges



Use a gouge where bone contouring is essential.

- 001355S** Gouge 12mm 140mm Long
- 001355** Gouge 12mm 205mm Long
- 001356** Gouge 10mm 140mm Long
- 001357** Gouge 8mm 140mm Long
- 001358** Gouge 6mm 140mm Long
- 001359** Gouge 4mm 140mm Long

## Orthopaedic Mallet



For use with osteotomes, chisels, gouges & staples. Different weights are available according to surgeon preference & patient size.

- 001323** Mallet 140g 155mm Long
- 001320** Mallet 300g 220mm Long
- 001321** Heavy Mallet 500g 240mm Long
- 001325** Nylon Faced Mallet 500g 240mm Long
- 001326** Nylon Faced Mallet 300g

## Volkman Bone Scoop



Useful for heavy curettage & collection of cancellous bone grafts.

- 782200** Volkman Single Ended Scoop 4mm 170mm Long
- 782205** Volkman Single Ended Scoop 3mm 170mm Long
- 782210** Volkman Single Ended Scoop 5mm 170mm Long
- 782220** Volkman Single Ended Scoop 6mm 170mm Long
- 782600** Volkman Double Ended Scoop Small 4mm/6mm 200mm Long
- 782610** Volkman Double Ended Scoop Medium 5mm/6mm 200mm Long
- 782620** Volkman Double Ended Scoop Large 6mm/8mm 200mm Long

## Trephine



Stainless steel & re-usable with a retractable stylet. Extend the stylet to provide secure location at the trephine site until trephine teeth bite. Withdraw the stylet to harvest the bone. Push the bone core out using the stylet. Where a very long core is required the stylet may be removed completely.

- Creation of window for bone graft harvest.
- Cortical bone biopsy.

**001425** Trephine 8mm o/d 6mm Core 170mm Long

**001426** Trephine 6mm o/d 4mm Core 115mm Long

**001427** Trephine 5mm o/d 3mm Core 115mm Long

## Vi Pattern Orthopaedic Distractor



### Application & Features:

- Overcoming muscle contraction prior to fracture reduction.
- Accurate alignment of bone fragments prior to plating.
- Locking wing nuts fix the distractor as a scaffold for the bone fragments to facilitate plating.
- Three joints maximise flexibility.
- Use with external fixation pins 3.2mm to 4.0mm.

**001500** Vi Pattern Orthopaedic Distractor 330mm Long

## Small Distractor With Ratchet



The Small Ratcheted Distractor uses 1.5 or 1.6 K or A wires as distraction pins. The pins are driven into place through the tubes on the distractor arm. Threaded pins may be used for additional security. Squeezing the arms of the distractor separates the pins & thus the bone fragments & the ratchet holds them in the new position. Range of distraction 12mm - 60mm.

**001503** Small Distractor With Ratchet 185mm Long

## Bone Scribe



A very sharp marking point with an easy-to-hold handle enables the surgeon to mark bone prior to creation of an osteotomy. One end is pointed & the other is sharpened as a blade.

**001494** Bone Scribe Double Ended 200mm Long

## Measuring Devices

### Vernier Caliper



Useful for very accurate measurement of screws and drill bits. Supplied with full instructions for use. Accurate to 0.1mm.

**001490** Vernier Caliper Stainless Steel

**001490D** Digital Vernier (Non Autoclavable)

### Drill & Screw Gauge



Measures screws up to 60mm & drills from 1.1mm to 3.5mm.

**001496** Drill & Screw Gauge 60mm Long

### Vi Metric Ruler



Metric ruler covering the more common drill, screw & wire sizes.

**001504** Metric Ruler - Vi

### Imperial Ruler

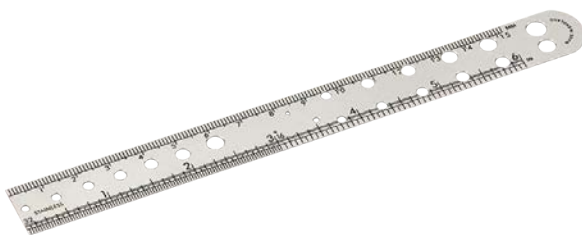

Used to measure pins, wires, drills & screw sizes.

**001498** Orthopaedic Ruler Imperial 175mm Long

### Radiographic Aids Xray Marker With Scale



A reliable scale is very important, regardless of the system used, particularly when submitting radiographs for an opinion. Left/right markers are essential. A flexible stand is also available allowing this combined marker to be positioned at the same level as the area of interest to improve accuracy.

**XRAYMARKI** Xray Marker With Scale Set Left & Right  
**XRAYHOLDI** Xray Marker Stand

### Radiographic Reference Ball



Reduce scaling errors when templating for implants or examining structures, using digital or analogue systems. Using a spherical object as a reference eliminates errors created by ruler orientation which might not be quite parallel with the plate.

Supplied on a stable base with a flexible neck, allowing positioning at the same level as the area of interest.

**XRAY25MM** Radiographic Reference Ball 25mm Diameter  
**XRAY10MM** Radiographic Reference Ball 10mm Diameter  
**XRAYBALLSET** Xray Ball Set 25mm & 10mm

## Implant Cutters

Select implant cutters to suit the type & size of implant to be cut, & the position of the implant. Using hacksaws is best avoided as far as possible – due to the work hardening characteristic of stainless steel & titanium, the harder you work the harder it is to cut. Intramedullary pins & K/A wires are already hardened during production so are even tougher.

Designs & finish of cutter:

Surgical finish stainless steel with TC inserts – suitable for appropriate sizes of hard wires. Can be used for appropriate sizes of cuttable plate.

Also for cutting fish hooks!

Side cutting – standard pattern straight cutters.

Close cut – end cutting. For smaller pins only. Harder to cut long sections but allow cutting close to the bone.

Safety cutters – leave a blunt end with no snags, but leave a longer stub. Best for ex fix pins.

Compound action – more expensive but make cutting pins easier.

Prolong the life of your pin cutter by not cutting at the tip – as tungsten carbide is brittle, it is prone to break when cutting at the very tip, where it is less well supported by the stainless jaw.

### Implant Cutter Selection Chart

Maximum Pin Size	Code	Description
1.5mm	001230	Implant Cutter to 1.5mm
	001238	Implant Cutter to 1.5mm Close Cut
1.6mm	001247	Safety Sheer Cutter to 1.6mm Close Cut
2.0mm	001237/1	Implant Cutter to 2.0mm 255mm
2.2mm	001246	Implant Cutter to 2.2mm Oblique Jaw
	001237	Implant Cutter to 2.2mm
	001236	Implant Cutter to 2.2mm Close Cut
3.0mm	001228	Implant Cutter to 3.0mm
	001234	Implant Cutter to 4.0mm
4.0mm	001231/A	Implant Cutter to 4.0mm Detachable Handles
	001229	Safety Cutter to 4.0mm
6.0mm	001231VL	Implant Cutter to 6.0mm Compound



## Implant Cutter Surgical Finish To 1.5mm Capacity



Implant Cutter Surgical Finish to 1.5mm Capacity, 150mm Long.

**001238** Implant Cutter Stainless To 1.5mm Capacity  
Close Cut 150mm Long

## Implant Cutter Surgical Finish To 1.5mm Capacity



Small lightweight implant cutter. Max capacity 1.5mm. Also suitable for 1mm cuttable plate range. For light use only.

**001230** Implant Cutter Stainless To 1.5mm Capacity 170mm Long



### Email Marketing Service

Our marketing emails are designed to educate, to keep you up to date with what's new at Vi & share exclusive offers & discounts.

Sign up today by scanning the QR code below.



### Implant Cutter Surgical Finish To 1.6mm Capacity



An efficient shearing action that produces a square end to a cut pin rather than the more typical sharp edge. The jaws catch the loose pin end preventing it from flying off. This cutter cuts pins to 1.6mm below the face of the cutter. Also useful for cutting cerclage wire cleanly. TC Jaws.

**001247** Implant Cutter Stainless Steel Cuts To 1.6mm Capacity 220mm Long

### Implant Cutter Surgical Finish To 2.0mm Capacity



Implant Cutter Stainless Steel Cuts To 2.0mm Capacity 255mm Long Simple Action.

**001237/1** Implant Cutter Stainless Steel Cuts To 2.0mm Capacity 255mm Long Simple Action

### Implant Cutter Surgical Finish To 2.2mm Capacity



Similar to 001237, but with oblique jaws favoured by many surgeons. Tungsten Carbide jaws.

**001246** Implant Cutter Stainless Steel Cuts To 2.2mm Capacity 255mm Long

### Implant Cutter Surgical Finish To 2.2mm Capacity



Implant Cutter Surgical Finish to 2.2mm Capacity, TC Jaws, Sprung Compound Action, 230mm Long.

Very useful for A & K wires, & cuttable plates.

**001237** Implant Cutter Stainless Steel Cuts To 2.2mm Capacity 230mm Long

### Implant Cutter Surgical Finish To 2.2mm Capacity

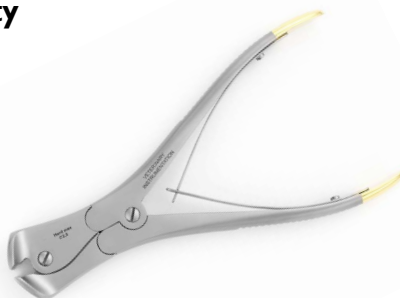

Implant cutter surgical finish with TC jaws. End cut to 2.2mm capacity. Sprung compound action. 230mm long.

**001236** Implant Cutter Stainless Steel Cuts To 2.2mm Capacity 230mm Long End Cut

### Implant Cutter Surgical Finish To 3mm Capacity



Implant Cutter Surgical Finish to 3mm Capacity, TC Jaws, 255mm Long.

**001228** Implant Cutter Stainless To 3mm Capacity 255mm Long

### Implant Cutter Surgical Finish To 4mm Capacity Detachable Handles



Overall length with handles in situ is 485mm. Strips down to 270mm long when handles are detached to fit many smaller autoclaves.

**001231/A** Implant Cutter Stainless To 4mm Capacity Detachable Handles



### Safety Cutter Surgical Finish To 4mm Capacity



Safety implant cutter which leaves a smoother cut end than a conventional cutter. Very useful for external fixation pins. Cut end is temporarily retained within the head rather than flying off.

Maximum capacity 4mm. Cuts 5mm below the face of the cutter.

Telescopic handles reduce the overall length from 470mm to 340mm to fit most autoclaves. Head strips for cleaning.

001229 Safety Cutter Stainless Steel Cuts To 4.0mm Capacity 340mm Long

### Implant Cutter Surgical Finish To 6mm Capacity



Highest capacity implant cutter stocked. Will not fit most autoclaves as they are 560mm long – suggested to use chemical sterilant on the jaws & operate by an unscrubbed assistant.

001231VL Implant Cutter Stainless Steel Cuts To 6mm Capacity TC Jaws 560mm Long

### Implant Cutter Surgical Finish To 4mm Capacity



001234 Implant Cutter Stainless Steel Cuts To 4mm Capacity TC Jaws 370mm Long



### ViPP

Through a true partnership approach, you can deliver quantifiable rewards for you and your Practice by joining our **Veterinary Instrumentation Partnership Programme.**

To find out more, scan the QR code below.



### Pin & Wire Extraction Pin Grip



For the removal of temporary fixation pins. Narrow jaws allow access via a small incision, with a groove in the jaw to locate the pin. Jaws can be locked in position once the pin is located, to aid removal.

001241 Pin Grip Stainless Steel Modified Jaw 175mm Long

### Dental Forceps For Pin & Wire Extraction



For pin, wire & screw extraction. Grooved tips come to a point, allowing work in confined spaces & close to bone with a reduced surgical approach. Anatomical handles & cranked jaws for ease of use.

001248 Dental Forceps for Pin & Wire Extraction

### Parallel Action Pliers



Useful for bending, holding & cutting small pins & wires. Used in conjunction with bone plate benders for contouring smaller plates. Will cut arthrodesis & K wires to a maximum of 2.0mm with care.

001290 Parallel Action Pliers Stainless Steel 170mm

### Wire Contouring Pliers



Use to contour both soft & hard wires. The jaw design has multiple anvil shapes & a pair of soft wire cutters.

001245 Wire Contouring Pliers 150mm Long

### K Wire/A Wire Extraction Forceps



Designed to firmly grip wires 0.9mm to 2.0mm. Tungsten Carbide jaws maximise grip, fine nose minimises trauma to surrounding tissue.

001244 K Wire/A Wire Remover 140mm Long

### Small Pin Vice



This Small Pin Vice holds pins & wires up to a diameter of 1.0mm. Particularly useful for fingertip control over insertion of Arthrodesis & K Wires.

001223 Small Pin Vice 100mm Long

## Jacobs Chuck



Standard instrument for for hand insertion of intramedullary pins.

Pin capacity Standard Chuck up to 1/4" (6mm)  
Small Chuck up to 5/32" (4mm)

Standard chuck will grip small pins, but is heavier in use.

Clean thoroughly & lubricate well, opening & closing jaws fully during cleaning procedure to maintain in good condition.

001220	Small Jacobs Chuck with Handle 5/32" Capacity 260mm
001605S	Replacement 5/32" Chuck & Key Only - No Handle
001606S	Spare Key For 5/32" Chuck
001221	Standard Jacobs Chuck with Handle 1/4" Capacity
001605	Replacement 1/4" Chuck & Key Only - No Handle
001606	Spare Key For 1/4" Chuck

## Wire Passers



Wire passers are designed to direct cerclage wire around long bones with minimal trauma, helping reduce devascularisation of fragments. Soft tissue attachments should be preserved as far as possible.

001250	Wire Passer Double-Ended 145mm
001252	Wire Passer Single-Ended 20mm Diameter 205mm
001253	Wire Passer Single-Ended 30mm Diameter 220mm
001254	Wire Passer Single-Ended 40mm Diameter 250mm
001256	Wire Passers Single-Ended Set of 3 (As Above)
001257	XXL Wire Passer Single-Ended 55mm Diameter

## Strong Cerclage Wire Passers



Low profile open channel wire passers, designed to allow easier passage around & between bones. Can be left in situ as wire is tightened, reducing risk of slippage. Wire can be passed from tip or handle. With a flat internal tip to assist close passage around the bone.

Designed by David Strong MRCVS.

CWPSM	Strong Cerclage Wire Passer Small 12.5mm/15mm
CWPMD	Strong Cerclage Wire Passer Medium 20mm/25mm
CWPLG	Strong Cerclage Wire Passer Large 30mm/40mm
CWPSET	Strong Cerclage Wire Passer Set of 3

## Lesser Wire Passer/Retrieval Forceps



Really useful forceps which combine the function of a tissue protector drill guide with a method of capturing the wire on the blind side of the procedure. The open sided guide tube is toothed to minimise drill skate.

Most common applications include hemi-cerclage & passage of lateral sutures through the tibial crest.

Original design by Arnie Lesser.

001268	Lesser Wire Passer/Retrieval Forceps 150mm Long
001269	Lesser Wire Passer/Retrieval Forceps Large 190mm Long

## Orthopaedic Wire



Cerclage wire is an extremely useful method of fragment fixation. Use as thick a wire as seems possible. Twist evenly under tension. The best instrument is our Wire Twister/Cutter 001260. Minimise wire movement on periosteum. Tension wire banding should be performed where muscular forces must be transferred beyond a fracture or osteotomy, e.g. Tibial crest avulsion or trochanteric osteotomy. 1.0mm Wire is the most useful for mid-sized dogs. All are supplied in 10 metre rolls.

- OW0210** 32g Reel of Orthopaedic Wire 0.20mm
- OW0310** 30g Reel of Orthopaedic Wire 0.30mm
- OW0410** 27g Reel of Orthopaedic Wire 0.40mm
- OW0510** 25g Reel of Orthopaedic Wire 0.5mm
- OW0610** 24g Reel of Orthopaedic Wire 0.6mm
- OW0710** 22g Reel of Orthopaedic Wire 0.71mm
- OW0810** 21g Reel of Orthopaedic Wire 0.8mm
- OW0910** 20.5g Reel of Orthopaedic Wire 0.9mm
- OW1010** 20g Reel of Orthopaedic Wire 1.0mm
- OW1012** 18g Reel of Orthopaedic Wire 1.2mm
- OW1015** 16g Reel of Orthopaedic Wire 1.5mm



For convenience & identification rolls of orthopaedic wire can be marked with padlock security tags. This also has the added advantage of stopping rolls of wire unraveling in the operating theatre.

## Orthopaedic Wire Kit



Cerclage wire can be a very useful means of fragment fixation. Kit containing our most popular cerclage instruments & a roll of wire, discounted over component price.

Kit contains:

001260	Wire Twister	x1
001256	Set of 3 Single Ended Wire Passers	x1
OW1010	10m Roll of 1.0mm Orthopaedic Wire	x1

**OWKIT** Orthopaedic Wire Kit

## Wire Twister/Shear Cutter



- Jaws lock onto wire to enable easy twisting under tension for kink-free cerclage. The wire must be twisted under tension to create an even spiral
- Improved design, long life shear action cutter will cut 18 gauge (1.2mm) wire twisted double
- Serrated jaws grip & turn cut ends. Jaws have fenestration for extra grip
- Not designed to cut A + K Wires, Pins or fish hooks
- Available with Tungsten Carbide Jaws for extra grip (not fenestrated)

- 001260** Wire Twister/Shear Cutter 165mm Long
- 001261** Wire Twister/Shear Cutter - Tungsten Carbide Jaws 165mm Long

## Wires With Eyelet

The free end of the wire is threaded through the eye. The cerclage is tightened using the special tightener. Requires a device for tightening Eyed Wires, see 001262 & 001264

- CWWE22** Orthopaedic Wire With Eyelet 22g x 12" (Pack of 6)
- CWWE20** Orthopaedic Wire With Eyelet 20g x 12" (Pack of 6)
- CWWE18** Orthopaedic Wire With Eyelet 18g x 12" (Pack of 6)

## Wire Tightener For Eyed Wires



Used to tension eyed wires very tightly. The cerclage is finished by kinking the wire back against the eye.

- 001262** Wire Loop Tightener 125mm Long

## Wire Tightener With Two Cranks For Double Loop Cerclage & Eyed Wire



Use with single crank for eyelet wires. Use both cranks to tighten double loops.

- 001264** Wire Tightener With Two Cranks 240mm Long

## Plaster Cutting



Simple action serrated jaw. Very robust & comfortable to use. Very efficient for removing bandages.

**161405** Plaster Shears Bruns/Bohler 245mm Long

## Plaster Shears Stille



Very powerful compound action.

**161406** Plaster Shears Stille 245mm Long

## Plaster Spreaders



Cast spreader scaled to veterinary patients, to expand the initial cut made to remove a cast.

**161410** Plaster Spreaders 230mm



## Training & Education

Our **e-learning platform** delivers a variety of technical and clinical educational material, in an engaging and interactive format.

With a CPD certificate awarded upon successful completion of each module, the e-learning platform from Vi will help you to fulfil your annual CPD requirements.

Sign up today by scanning the QR code below.



## Biopsy Needles

Biopsy Needle	Patient Body Weight	Needle Gauge
Bone Marrow	<5kg	18g
	5-15kg	15/16g
	15-30kg	13g
	30-50kg	11g
	>50kg	8g
Cortical Bone	<5kg	11g
	5-15kg	8g
	>50kg	Trephine

### Biopsy Needles - Bone Marrow Biopsy - Jamshidi Type

In the Jamshidi Type Needle the integral stylet locks into the lumen of the needle preventing obstruction by debris. When the needle tip is in the desired location the stylet is removed & the sample aspirated.

The 11 gauge needle with the stylet removed may be used to take a 1.5mm approx. core of bone from tumours for typing.



**XS15030-00** 15g Disposable Illinois Style Bone Marrow Biopsy Needle

### Vi Jamshidi Type Range



Drive into a suitable site (wing of ilium, tuber ischium, proximal femur), pull back a little, withdraw stylet & aspirate. If there is no aspirate, replace stylet, push in further & repeat.

- BMBJV16** VI Jamshidi Type Disposable 16g
- BMBJV13** VI Jamshidi Type Disposable 13g
- BMBJV11** VI Jamshidi Type Disposable 11g
- BMBJV8** VI Jamshidi Type Disposable 8g

### Bone Marrow Biopsy - Rosenthal



Similar to Klima. Stylet does not lock into position.

**012509** Bone Marrow Biopsy Rosenthal 16g x 35mm

### Trephine



Stainless steel & re-usable with a retractable stylet. Extend the stylet to provide secure location at the trephine site until trephine teeth bite. Withdraw the stylet to harvest the bone. Push the bone core out using the stylet. Where a very long core is required the stylet may be removed completely.

- Creation of window for bone graft harvest.
- Cortical bone biopsy.

- 001425** Trephine 8mm o/d 6mm Core 170mm Long
- 001426** Trephine 6mm o/d 4mm Core 115mm Long
- 001427** Trephine 5mm o/d 3mm Core 115mm Long

## Interosseus Infusion Needle 18g

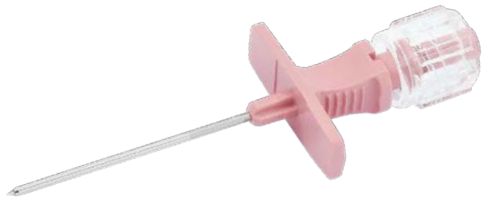

Where vascular access is difficult, fluids & most drugs can be administered via this interosseus infusion needle. This process is particularly useful in neonates & birds where blood vessels are very small.

The most common site is the proximal femur via the trochanteric fossa. An IV catheter should be placed as soon as practical. Also used as a small bone marrow aspiration needle in the Jamshidi style.

**BMBJV18** Interosseus Infusion Needle 18g

## Table Top Stand For Hanging Limb Preparation

Suspension of a limb can provide significant benefits in both arthroscopy & other orthopaedic procedures. The shoulder joint is distracted & 360 degree access becomes available. Height 1.2m (48") Our limb suspension stand was re-designed to give greater table-top stability. A cleat for tying of limb suspension ropes has been added & the shaft can be dismantled for storage.



**R463** Tabletop Stand For Hanging Limb Preparation

## Multi Arm With Limb Brace Attachment

Safety need not be compromised to obtain accurately positioned radiographs. The Multi Arm can replace the human hand in the positioning & holding of limbs for both radiography, surgery & arthroscopy. Also useful for hands-free positioning of bronchoscopes & gastroscopes.

- Use cohesive bandage to attach limb
- Three joints allow positioning at any angle
- A single knob locks all three joints rigid
- Clamp fixes device to virtually any operating or X-ray table
- Double limb support (for hip radiographs) available as an option
- As described by Kurt Schulz in Veterinary Surgery



**026000**

**020062**

**020065**

Multi Arm - Includes Single Limb Support  
Double Limb Support for MultiArm  
Limb Brace Attachment For Multi Arm



**MULTIARMSET** Multi Arm Set - Contains 026000, 020062 and 020065

## BIOCERA-VET® Portfolio

Vi are delighted to partner with TheraVet to exclusively distribute the BIOCERA-VET® portfolio to our customers across the UK and Ireland.

\*IFU available on request

### BIOCERA-VET® Bone Surgery RTU



BIOCERA-VET® BONE SURGERY RTU, ready-to-use highly injectable self-hardening calcium-phosphate cement, is made from tricalcium phosphate and ortho-phosphate salts that after crystallization give rise to calcium-deficient apatite crystals. This is chemically close to the mineral components in natural bone. Therefore, BIOCERA-VET® becomes well integrated in the bone matrix, resorbed by osteoclasts, and progressively replaced by newly-formed bone.

BIOCERA-VET® has a full range of micro, meso and macropores that makes it highly porous. This supports osteoconduction, facilitates cell colonization and biological fluid penetration, which promote bone remodeling and formation. In addition, once injected, BIOCERA-VET® makes close contact with the adjacent bone, providing mechanical support and promoting new bone formation. Its highly injectable and fast self-setting properties give you the possibility to save time and improve the efficiency of your bone surgeries.

BCV-RTU-001 BIOCERA-VET Bone Surgery RTU 1cc

BCV-RTU-002 BIOCERA-VET Bone Surgery RTU 3cc

### BIOCERA-VET® Combo-Clean



BIOCERA-VET® Combo-Clean features ideal properties of a bone substitute with local and sustained antibiotic delivery. Its high porosity allows an optimal osteointegration and promotes bone remodelling, provides stability along with antimicrobial action for up to 30 days\*.

BIOCERA-VET® Combo-Clean is made of tricalcium phosphate ( $\alpha$ -TCP) and ortho-phosphate salts to which an antibiotic is added and that gives rise to calcium-deficient apatite after crystallization.

After crystallization, BIOCERA-VET® Combo-Clean presents a high porosity (micro-, meso- and macro- pores) which supports bone remodeling through cell colonization and biological fluid penetration, and at the same time allows the paced release of antibiotic over time and its effect on local infection.

BCV-COMBOC-001 BIOCERA-VET Combo Clean ICC

### BIOCERA-VET® Bone Surgery Granules



BIOCERA-VET® GRANULES is a synthetic bone substitute made of calcium-deficient apatite (CDA) crystals, chemically close to the mineral composition of the natural bone.

BCV-G-001 BIOCERA-VET Bone Surgery Granules 5x1cc

BCV-G-002 BIOCERA-VET Bone Surgery Granules 3x3cc

BCV-G-003 BIOCERA-VET Bone Surgery Granules 3x5cc

### BIOCERA-VET® Bone Surgery Smart Graft



BIOCERA-VET® SMARTGRAFT is made of a bovine mineral bone matrix, bioresorbable polymers and collagen fragments. BIOCERA-VET® SMARTGRAFT is a tissue-engineering technology allowing the patient's cells to grow quickly and efficiently into the bone substitute while the biopolymers degrade, providing integration and osteogenesis.

The microstructure of the composite matrix is strongly similar to natural bone in terms of interconnected and mid-sized porosity promoting osteoconductivity. Its high wettability and hydrophilicity are ideal to support the bone formation process.

TVB102010 BIOCERA-VET Bone Surgery Smartgraft Fine 2.5cc

TVB102020 BIOCERA-VET Bone Surgery Smartgraft Fine 5cc

TVB251005 BIOCERA-VET Bone Surgery Smartgraft Ultrafine 1cc

TVB251020 BIOCERA-VET Bone Surgery Smartgraft Ultrafine 3.5cc

### BIOCERA-VET® Osteosarcoma RTU



Osteosarcoma is the most common type of bone cancer in dogs. Chemotherapy, limb-sparing procedure and/or amputation remain the mainstay of treatment. However, it is not always feasible.

Cementoplasty with BIOCERA-VET® OSTEOSARCOMA RTU provides a palliative solution, improving the quality of life of the patient suffering from osteosarcoma. Its percutaneous injection into lytic bone increases the bone's mechanical strength, reduces pain and the risk of pathological fractures, therefore providing a minimally invasive, lower-cost, and clinically valuable alternative to amputation.

BCV-RTU-003 BIOCERA-VET Osteosarcoma RTU 12cc

BCV-RTU-004 BIOCERA-VET Osteosarcoma RTU 2x12cc





## Veterinary Tissue Bank

Veterinary Tissue Bank is Europe's first tissue bank dedicated to helping companion animals.

Products are available in various presentations, & have many applications for use during procedures such as TTA Rapid & joint arthrodesis to dealing with the difficult non-union case.

Demineralised Bone Matrix (DBM) is cortical bone which has been cut, milled into fine particles & washed to remove soft tissues, cells & marrow elements. Further processing removes minerals to leave collagen matrix & endogenous bone growth factors such as bone morphogenic proteins.

DBM is used where osteoinduction is required but the graft does not require any structural properties, for example in small joint arthrodesis.

## Cancellous Chips



Cancellous Chips offer structure to a graft as well as providing a scaffold for osteoconduction.

This is available in canine & feline variants. Canine is available in 3 chip sizes for closer matching to defect size. The product consists of morcelised cancellous bone, processed to remove soft tissue, cells & marrow elements, freeze-dried & irradiated after packing for sterility.

Useful in TTA Rapid, filling corrective osteotomies, fracture repair, spinal fusions among other procedures. It is also useful for extending an autograft where harvesting has not produced sufficient material.

## DBM Products

Available as fibres, granules, chips or putty. DBM particulates are mixed with nanocrystalline hydroxyapatite aqueous suspension prior to use, in the syringes provided. The addition of hydroxyapatite provides a high surface area for osteoconduction, & allows the putty-like texture to form. The product sticks well to the bone surface & conforms to the defect, improving contact to bone. It can be injected into the surgical site direct from the syringe, e.g. in TTA, & will also pass through a 14g needle for non-invasive surgery such as MIPO.

## Graft Selection

Osteoinduction	—————→	DBM
Osteoconduction	—————→	Cancellous Chips
Osteoconduction & osteoinduction	—————→	DMB Putty/Fibres

<b>DBMPUTC1101</b>	VTB DBM Putty 1cc (Premixed)
<b>C0901</b>	DBM Canine 0.1-0.5mm Granules 1cc
<b>C0903</b>	DBM Canine 0.1-0.5mm Granules 3cc
<b>C0905</b>	DBM Canine 0.1-0.5mm Granules 5cc
<b>C1001</b>	DBM Canine 0.5-1.0mm Granules 1cc
<b>C1003</b>	DBM Canine 0.5-1.0mm Granules 3cc
<b>C1005</b>	DBM Canine 0.5-1.0mm Granules 5cc
<b>FL205</b>	DBM Feline 1.0mm 0.5cc
<b>C0101</b>	Cancellous Chips Canine 2-4mm Chip Size Coarse 1cc
<b>C0103</b>	Cancellous Chips Canine 2-4mm Chip Size Coarse 3cc
<b>C0105</b>	Cancellous Chips Canine 2-4mm Chip Size Coarse 5cc
<b>C0201</b>	Cancellous Chips Canine 1-2mm Chip Size Medium 1cc
<b>C0203</b>	Cancellous Chips Canine 1-2mm Chip Size Medium 3cc
<b>C0205</b>	Cancellous Chips Canine 1-2mm Chip Size Medium 5cc
<b>C0301</b>	Cancellous Chips Canine <1mm Chip Size Fine 1cc
<b>C0303</b>	Cancellous Chips Canine <1mm Chip Size Fine 3cc
<b>C0305</b>	Cancellous Chips Canine <1mm Chip Size Fine 5cc
<b>FL105</b>	Cancellous Chips Feline <2mm Chip Size Fine 1cc

All products are subject to availability. Feline products are often in short supply.

## NanoPaste Bone Substitute

Use to save time harvesting autograft or when the quality of the autograft is poor. NanoPaste will extend autograft.

The sterile presentation is an aqueous paste supplied in a syringe (2.5ml or 5.0ml). The paste may be injected directly into a defect where it conforms to fill the space. The paste is readily colonised by bone cells & acts as a scaffold encouraging penetration of host bone. The putty-like consistency means that the paste may be pressed onto bone where it sticks until resorbed.

Nano HA paste conforms to ENISO 13779-1:200 & ASTM F1185-88 for medical grade HA.

Applications include: joint arthrodesis, TTA Rapid, non-unions, delayed unions & filling spine cages.



**PAS2.5** NanoPaste Syringe 2.5ml  
**PAS5** NanoPaste Syringe 5ml



# Joint Surgery



To view the Joint Surgery chapter of our website, please scan the QR code.



# Training & Education Support Programmes

## E-Learning Platform



The Vi e-learning platform delivers a variety of veterinary educational material in an engaging and interactive format. Whether you are a Veterinary Surgeon, a Veterinary Nurse, a Student VN or an Animal Care Auxiliary, you should find modules and content that are clinically relevant to you. With CPD certificates available, our e-learning content can help you to fulfil your annual CPD requirements, at the click of a button and from the comfort and convenience of your home or workplace. The e-learning platform also allows access to recordings of all Vi webinars, and new content is added periodically, so make sure you log in regularly to see what's new!



Scan to register for e-learning today!



## Practical Courses



Continuing Professional Development is one of our core company values. Vi supported the delivery of 145 CPD courses in 2023, both within the UK and Internationally, investing over £97,000 per annum to ensure the facilitation of successful training courses and development of Veterinary healthcare professionals.



Scan to see our CPD course calendar!

## Webinars



Since 2021, Vi have been delivering bimonthly KOL-led webinars. These live, interactive, free-to-attend sessions continue to soar in popularity with our audience, old and new! In 2023, we welcomed more than 2600 live attendees! An attendance certificate is provided to all live attendees, so these clinically relevant and engaging sessions are the ideal way to help fulfil your annual CPD requirements.



Scan to register for webinar updates!

## Vi Locking TPLO Starter Kit

Our range of TPLO kits are an excellent way to obtain the appropriate equipment which enables you to complete the TPLO procedure. Available with or without our battery powered TPLO saw.



Vi TPLO Starter Kit contains:

VILTPLOSAW	Vi Battery Powered TPLO Saw W/ Charger & Batteries	x1
001492	Slocum Type Rotation Gauges 5mm To 15mm	x1
001494	Bone Scribe (200mm Long)	x1
TPLOROT	TPLO Rotation Chart	x1
TPLO32	Slocum Guide 3.2mm (1/8") x 125mm Pins For TPLO 25mm Thread	x10
TPLOJIG	TPLO Basic Jig	x1
TPLOVI18	TPLO Blade Vi Pattern 18mm	x1
TPLOVI21	TPLO Blade Vi Pattern 21mm	x1
TPLOVI24	TPLO Blade Vi Pattern 24mm	x1
VILTPLO27L3	Locking TPLO Plate For 2.7mm Screws 3 Holes Proximal Left	x1
VILTPLO27R3	Locking TPLO Plate For 2.7mm Screws 3 Holes Proximal Right	x1
VILTPLO35BL4	Locking TPLO Broad Plate For 3.5mm Screws 4 Holes Proximal Left	x1
VILTPLO35BR4	Locking TPLO Broad Plate For 3.5mm Screws 4 Holes Proximal Right	x1
VILTPLO35L3	Locking TPLO Plate For 3.5mm Screws 3 Holes Proximal Left	x2
VILTPLO35R3	Locking TPLO Plate For 3.5mm Screws 3 Holes Proximal Right	x2

**VILTPLOKITBAT** Vi TPLO Locking Starter Kit With Battery Saw Power

**VILTPLOKITNP** Vi TPLO Locking Starter Kit has the same components as the kit list above excluding the **VILTPLOSAW**.

**VILTPLOKITNP** Vi TPLO Locking Starter Kit With No Power Equipment

To view our Surgery Guide on 'TPLO', please scan the QR code below.



Vi TPLO Starter Kit in Modular Plating Box contains:  
Modular Plating Box and 3 Instrument Trays.

UDG27	Universal Drill Guide for 2.7mm Screws	x1
UDG35	Universal Drill Guide for 2.7mm Screws	x1
LSDG2724XL	Locking Screw Drill Guide For 2.7mm Screws XL	x1
LSDG35XL	Locking Screw Drill Guide For 2.7mm Screws XL	x1
TPLOJIG	TPLO Basic Jig	x1
TPLO32	Slocum Guide 2.3x125mm Pins F/ TPLO 25mm Thread	x3
001529	1.6mm Ellis Pin 85mm	x2
001492	Slocum Rotation Gauges 5-15mm	x1
001494	Bone Scribe 200mm	x1
001499	TPLO Rotational Gauge Divider	x1
TPLOROT	TPLO Rotation Chart	x1
DGP2735	Premium Depth Gauge F/ 2.7/3.5mm Screws	x1
E17-079	Soft Touch QR Inline Handle W/ AO Coupling Yellow	x1
SDT1535	Star Drive T15 Insert F/ 3.5mm Locking Screws	x1
SDT82427	Star Drive T8 Insert F/ 2.4/2.7mm Locking Screws	x1
TPLOVI18	TPLO Blade Vi Pattern 18mm	x1
TPLOVI21	TPLO Blade Vi Pattern 21mm	x1
TPLOVI24	TPLO Blade Vi Pattern 24mm	x1
MPBSC27-MIX	2.7mm Screw Caddy With Star Drive Locking & Cortical Screws	x1
MPBSC35-MIX	3.5mm Screw Caddy With Star Drive Locking & Cortical Screws	x1
VILTPLO27L3	2.7mm Locking TPLO Plate 3 Hole Proximal Left	x2
VILTPLO27R3	2.7mm Locking TPLO Plate 3 Hole Proximal Right	x2
VILTPLO35L3	3.5mm Locking TPLO Plate 3 Hole Proximal Left	x2
VILTPLO35R3	3.5mm Locking TPLO Plate 3 Hole Proximal Right	x2
VILTPLO35SL3	3.5mm Small Locking TPLO Plate 3 Hole Proximal Left	x2
VILTPLO35SR3	3.5mm Small Locking TPLO Plate 3 Hole Proximal Right	x2
H090102	2mm Shank Drill 110mm Round	x1
H090103	2.8mm Shank Drill 130mm Round	x1
H090112	2.5mm Shank Drill 120mm Round	x1

**VILTPLOKIT-I** Vi Locking TPLO Kit 2735 No Power

**VILTPLOKIT-IQC** Vi TPLO Kit 2735 Drill Bits No Power has the same components as the kit list above but includes QC drill bits instead of round shank.

**VILTPLOKIT-IQC** Vi TPLO Kit 2735 Drill Bits No Power

## Small Vi Locking TPLO Starter Kit

We have now also launched smaller locking TPLO kits due to the trend of smaller dog breeds requiring this type of surgery.



Vi TPLO Locking Kit With 1.5mm/2.0mm/2.7mm Plates contains:

VITPLOSAW	Vi Battery Powered TPLO Saw W/ Charger & Batteries	x1
VILTPLO15L3	Locking TPLO Plate For 1.5mm Screws Left	x2
VILTPLO15R3	Locking TPLO Plate For 1.5mm Screws Right	x2
VILTPLO20L3	Locking TPLO Plate For 2.0mm Screws Left	x1
VILTPLO20R3	Locking TPLO Plate For 2.0mm Screws Right	x1
VILTPLO27L3	Locking TPLO Plate For 2.7mm Screws Left	x1
VILTPLO27R3	Locking TPLO Plate For 2.7mm Screws Right	x1
TPLOV112	TPLO Blade Vi Pattern 12 mm	x2
TPLOV115	TPLO Blade Vi Pattern 15 mm	x1
TPLOJIGXS	XSTPLO Jig 60mm	x1
TPLO32	Slocum Guide 3.2 x 125mm Pins For TPLO 25mm Thread	x1
001492	Slocum Rotation Gauges 5 - 15mm	x1
TPLOROT	TPLO Rotation Chart	x1
001494	Bone Scribe 200mm	x1

**VILTPLOKITBATXS** Vi TPLO Locking Kit With 1.5mm/2.0mm/2.7mm Plates

**VILTPLOKITXSNP** Vi TPLO Locking Starter Kit has the same components as the kit list above excluding the **VITPLOSAW**.

**VILTPLOKITXSNP** Vi TPLO Locking Starter Kit With No Power Equipment

Vi TPLO Starter Kit in Modular Plating Box contains:  
Modular Plating Box and 3 Instrument Trays.

UDG20	Universal Drill Guide for 2.0mm Screws	x1
UDG24	Universal Drill Guide for 2.4mm Screws	x1
LSDG20	Locking Screw Drill Guide for 2.0mm	x1
LSDG2424	Locking Screw Drill Guide For 2.4mm	x1
TPLOJIGXS	XSTPLO Jig 60mm	x1
001529	1.6mm Ellis Pin 85mm	x4
001550	2.0mm Ellis Pin 127mm	x4
001492	Slocum Rotation Gauges 5-15mm	x1
001494	Bone Scribe 200mm	x1
001499	TPLO Rotational Gauge Divider	x1
TPLOROT	TPLO Rotation Chart	x1
DGP2024	Premium Depth Gauge F/ 2.0/2.4mm Screws	x1
E17-079	Soft Touch QR Inline Handle W/ AO Coupling Yellow	x1
D17-080	Soft Touch QR Inline Handle W/ Dental Coupling Grey	x1
SDT620-A	Star Drive T6 Inset for 2.0mm Locking Screws	x1
SDT82427	Star Drive T8 Inset for 2.4/2.7mm Locking Screws	x1
TPLOV112	TPLO Blade Vi Pattern 12mm	x1
TPLOV115	TPLO Blade Vi Pattern 15mm	x1
TPLOV118	TPLO Blade Vi Pattern 18mm	x1
MPBSC20-MIX	2.0mm Screw Caddy With Star Drive Locking & Cortical Screws	x1
MPBSC24-MIX	2.4mm Screw Caddy With Star Drive Locking & Cortical Screws	x1
VILTPLO20L	2.0mm Locking TPLO Plate 3 Hole Proximal Left	x2
VILTPLO20R	2.0mm Locking TPLO Plate 3 Hole Proximal Right	x2
VILTPLO24L	2.4mm Locking TPLO Plate 3 Hole Proximal Left	x2
VILTPLO24R	2.4mm Locking TPLO Plate 3 Hole Proximal Right	x2
H090101	1.5mm Shank Drill 90mm Round	x1
H090208	1.8mm Shank Drill 110mm Round	x1

**VILTPLOKIT-2** Vi Locking TPLO Kit 2.0/2.4 No Power

## VILTPO Locking TPLO Plates



### Key design features:

- Contoured to the shape of the post TPLO proximal tibia
- The most proximal screw is placed just below the stifle joint but the locking hole is angled distally by 3° for the 3.5mm plate, 2.0° for the 3.5mm broad plate, 1.5° for the 2.7mm plate & 2.3° for the 2.4mm & 2.0mm plate, avoiding intra-articular placement
- 3-4 proximal locking screws provide maximal screw security in soft cancellous bone of the tibial plateau
- Medial buttress removal is not necessary because of the anatomic contour of the plate & locking screws proximally
- Distal segment allows placement of:
  - two non-locking screws including one for axial compression & maximal osteotomy stability
  - then choice of one or two locking/non-locking compression screws per plate hole
- Full range of plate sizes
- Fully compatible with Vi /AO style twin-start screw locking thread profile

<b>VILTPO15L3</b>	Locking TPLO Plate For 1.5mm Screws 3 Holes Left
<b>VILTPO15R3</b>	Locking TPLO Plate For 1.5mm Screws 3 Holes Right
<b>VILTPO20L</b>	Locking TPLO Plate For 2.0mm Screws 3 Holes Left
<b>VILTPO20R</b>	Locking TPLO Plate For 2.0mm Screws 3 Holes Right
<b>VILTPO24L</b>	Locking TPLO Plate For 2.4mm Screws 3 Holes Left
<b>VILTPO24R</b>	Locking TPLO Plate For 2.4mm Screws 3 Holes Right
<b>VILTPO27L3</b>	Locking TPLO Plate For 2.7mm Screws 3 Holes Left
<b>VILTPO27R3</b>	Locking TPLO Plate For 2.7mm Screws 3 Holes Right
<b>VILTPO35SL3</b>	Locking TPLO Plate Small For 3.5mm Screws 3 Holes Left
<b>VILTPO35SR3</b>	Locking TPLO Plate Small For 3.5mm Screws 3 Holes Right
<b>VILTPO35L3</b>	Locking TPLO Plate For 3.5mm 3 Holes Left
<b>VILTPO35R3</b>	Locking TPLO Plate For 3.5mm 3 Holes Right
<b>VILTPO35BL4</b>	Locking TPLO Plate Broad For 3.5mm Screws 4 Holes Left
<b>VILTPO35BR4</b>	Locking TPLO Plate Broad For 3.5mm Screws 4 Holes Right

## Vi Locking TPLO Plates



These TPLO plates are available in 2.7mm, 3.5mm & 3.5mm broad, covering the vast majority of TPLO patients.

The locking holes are both convergent & divergent to maximise pull-out resistance & angled to avoid articular surfaces.

<b>TPLO27LPCL</b>	TPLO Plate Locking 2.7mm Left
<b>TPLO27LPCR</b>	TPLO Plate Locking 2.7mm Right
<b>TPLO35LPCL</b>	TPLO Plate Locking 3.5mm Left
<b>TPLO35LPCR</b>	TPLO Plate Locking 3.5mm Right
<b>TPLO35BLPCL</b>	TPLO Plate Broad Locking 3.5mm Left
<b>TPLO35BLPCR</b>	TPLO Plate Broad Locking 3.5mm Right
<b>TPLO35MLPCR</b>	TPLO Narrow Head Broad Locking Plate Right 3.5mm
<b>TPLO35MLPCL</b>	TPLO Narrow Head Broad Locking Plate Left 3.5mm

## TPLO353555 Locking Plates



Right & left pre-contoured locking versions of the original TPLO353555 clover leaf plate developed by Phil Moses (Brisbane). All the screws are set to avoid the joint space & allow for optimal load sharing. Locking holes are all stacked so will accept a cortical screw if necessary, & there are two compression holes in the plate shaft.

<b>TPLO353555RL</b>	3.5mm DCP 55mm Length Locking Right
<b>TPLO353555LL</b>	3.5mm DCP 55mm Length Locking Left

## TPLO Saw Blades Vi Pattern



Vi's updated TPLO Blade has been redesigned to further reduce friction & improve cut characteristics in all sizes.

<b>TPLOVI12</b>	TPLO Blades Vi Pattern 12mm
<b>TPLOVI15</b>	TPLO Blades Vi Pattern 15mm
<b>TPLOVI18</b>	TPLO Blades Vi Pattern 18mm
<b>TPLOVI21</b>	TPLO Blades Vi Pattern 21mm
<b>TPLOVI24</b>	TPLO Blades Vi Pattern 24mm
<b>TPLOVI27</b>	TPLO Blades Vi Pattern 27mm
<b>TPLOVI30</b>	TPLO Blades Vi Pattern 30mm
<b>TPLOVI34</b>	TPLO Blades Vi Pattern 34mm

## TPLO Saw Blade 9mm



Vi are pleased to offer a 9mm radial cut TPLO blade by Rita Leibinger. Standard triangular mount fitting.

<b>TPLOBLEI09</b>	Rita Leibinger 9mm TPLO Saw Blade
-------------------	-----------------------------------

## TPLO By Wedge Osteotomy

### Cloverleaf Plates



- TPLO202026** 2.0mm DCP 26mm Overall Length
- TPLO202031** 2.0mm DCP 31mm Overall Length
- TPLO242434** 2.4mm DCP 34mm Overall Length
- TPLO242441** 2.4mm DCP 41mm Overall Length
- TPLO272739** 2.7mm DCP 39mm Overall Length
- TPLO272745** 2.7mm DCP 45mm Overall Length
- TPLO273539** 2.7/3.5 DCP 39mm Overall Length  
Allows Use Of 3.5 Cancellous Screw In Head
- TPLO273545** 2.7mm/3.5mm DCP 45mm Overall Length 2.5mm Thick
- TPLO353555** 3.5mm DCP 55mm Overall Length
- TPLO353557** 3.5mm DCP 57mm Overall Length Heavy Duty
- TPLO353559** 3.5mm DCP 59mm Overall Length
- TPLO353562** 3.5mm DCP 62mm Overall Length
- TPLO353565** 3.5mm DCP 65mm Overall Length
- TPLO353577** 3.5mm DCP 77mm Overall Length
- TPLO353577X** 3.5mm DCP 77mm Overall Length Extra Shaft Hole
- TPLO353579** 3.5mm DCP 79mm Overall Length Heavy Duty
- TPLO354579** 3.5mm/4.5mm DCP 79mm Overall Length Heavy Duty  
Allows 4.5mm Screws In Head
- TPLO35456579** 79mm Overall Length Heavy Duty  
Allows 4.5mm/6.5mm Screws In Head
- TPLO45659030** 4.5mm DCP 90mm Overall Length  
Will Accept 6.5mm Cancellous Screws In Head 3.0mm Thick
- TPLO45659035** 4.5mm DCP 90mm Overall Length  
Will Accept 6.5mm Cancellous Screws In Head 3.5mm Thick
- TPLO45659045** 4.5mm DCP 90mm Overall Length  
Will Accept 6.5mm Cancellous Screws In Head 4.5mm Thick
- TPLOO** Angle Finder & Plate Overlay

## Slocum Style Plates



Slocum style TPLO plates. Not pre-contoured.

- TPLOS20L** TPLO Plate Slocum Style 2.0mm Left
- TPLOS20R** TPLO Plate Slocum Style 2.0mm Right
- TPLOS24L** TPLO Plate Slocum Style 2.4mm Left
- TPLOS24R** TPLO Plate Slocum Style 2.4mm Right
- TPLOS27L** TPLO Plate Slocum Style 2.7mm Left
- TPLOS27R** TPLO Plate Slocum Style 2.7mm Right
- TPLOS27BL** TPLO Plate Broad Slocum Style 2.7mm Left
- TPLOS27BR** TPLO Plate Broad Slocum Style 2.7mm Right
- TPLOS35L** TPLO Plate Slocum Style 3.5mm Left
- TPLOS35R** TPLO Plate Slocum Style 3.5mm Right
- TPLOS35BL** TPLO Plate Broad Slocum Style 3.5mm Left
- TPLOS35BR** TPLO Plate Broad Slocum Style 3.5mm Right

## Pre-Contoured Slocum Style TPLO plates

Pre-contoured version of the standard 3.5mm Slocum Style plate. Pre-bent & polished to leave no stress riser. May need a final intra-operative tweak in some cases.

- TPLOS35RPC** 3.5mm Right Slocum Style Pre-Contoured Plate
- TPLOS35LPC** 3.5mm Left Slocum Style Pre-Contoured Plate

## Delta Style Plates



- TPLODEL24L** 2.4mm Delta Plate Left
- TPLODEL24R** 2.4mm Delta Plate Right
- TPLODEL27L** 2.7mm Delta Plate Left
- TPLODEL27R** 2.7mm Delta Plate Right
- TPLODEL27BL** 2.7mm Broad Delta Plate Left
- TPLODEL27BR** 2.7mm Broad Delta Plate Right
- TPLODEL35L** 3.5mm Delta Plate Left
- TPLODEL35R** 3.5mm Delta Plate Right
- TPLODEL35BL** 3.5mm Broad Delta Plate Left
- TPLODEL35BR** 3.5mm Broad Delta Plate Right



## TPLO Instrumentation

### XSTPLO Jig



Smallest TPLO Jig available from Vi. Design allows greater range of arm movement without causing intra-operative obstruction, with a single hinge to reduce bulk. Accepts 1.6mm & 2.0mm pins. 2.0mm Allen key included. Main body 60mm long.

**TPLOJIGXS.** XS TPLO Jig 60mm

### TPLO Jig



Basic TPLO jig, uses 3.2mm pins. Supplied with 2.5mm Allen key.

**TPLOJIG** TPLO Jig 120mm

### Standard Slocum Style TPLO Jig



Standard Slocum style TPLO jig. Pair of Alignment Bars & Allen key included.

Large Jig takes 3.2 pins, small Jig takes 2.4 pins. Pins not included.

- TPLOJIG/S.** Slocum Style Jig Standard (3.2mm Pin)
- TPLOJIG/SS.** Slocum Style Jig Small (2.4mm Pin)
- TPLOJIG/ROD35** Replacement Alignment Bars (Set of 2) Standard
- TPLOJIG/ROD27** Replacement Alignment Bars (Set of 2) Small
- ALLEN25** Allen Key Stainless Finish 2.5mm
- GRUBM5L5** Grub Screw M5 x 5mm

### Slocum TPLO Guide Pin

End threaded negative pin. Drive directly into the tibia for jig attachment.

- TPLO32** Slocum Guide Pin 3.2mm Thread 25mm
- BCNET24** 2.4mm Bicortical Negative End Thread Pin 100mm Long

### Slocum Rotation Gauges



The rotation gauges simplify the rotation procedure. The correct measurement, in millimetres, is read from the table & the appropriate gauge selected. The bone is marked using a bone scribe or an osteotome.

**001492** Slocum Rotation Gauges

### TPLO Rotation Gauge Divider Type



Alternative to the feeler gauge type measuring system. Spring loaded, adjusting the set screw fixes the points at any predetermined distance. The tibial plateau may then be rotated the distance between the points.

- 001499** TPLO Rotation Gauge Divider Type 0-20mm
- 001499L** TPLO Rotation Gauge Divider Type Large to 40mm

### TPLO Saw Blade Protractor

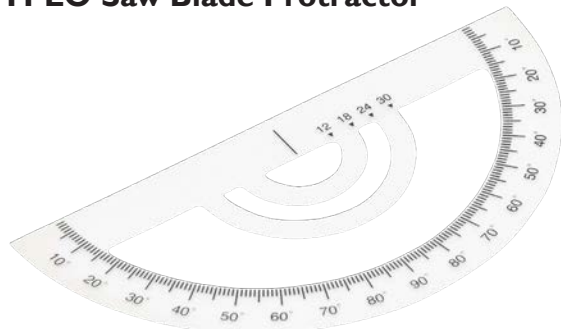

Use to accurately measure the tibial plateau slope. In addition the protractor is marked with blade outline to further assist in the planning of the TPLO procedure.

**TPLOPRO** TPLO Protractor

### TPLO Rotation Chart

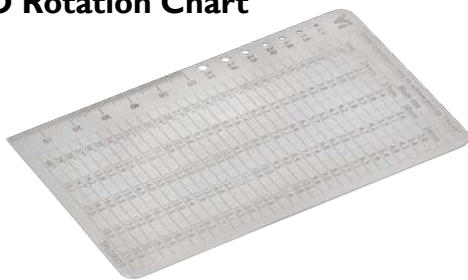

The rotation data for blades 12mm, 15mm, 18mm, 21mm, 24mm, 27mm, 30mm & 34mm are displayed on this double sided, laser marked, stainless steel gauge. Also incorporates a drill gauge & a ruler for measuring screws & rotation.

**TPLOROT** TPLO Rotation Chart

### Wedge Osteotomy Gauge Set 9° To 30°



Wedge gauges simplify the marking & cutting of the appropriate wedge. Using the parallel marking allows the surgeon to mark & cut a wedge with equal length borders, creating a better closure.

**001493** Wedge Osteotomy Gauge Set

### TPLO Reduction Forceps With Wire Guide



TPLO reduction forceps are designed to stabilise and compress across the osteotomy site. At the tip is a wire guide tube which allows a stabilising wire to be driven across the osteotomy at exactly the correct position without skidding or slippage at start up. The spin-lock allows full flexibility on positioning and compression. Available with the wire guide positioned on left or right side.

**TPLORFR** TPLO Reduction Forceps With Wire Guide Right  
**TPLORFL** TPLO Reduction Forceps With Wire Guide Left  
**TPLORFSET** TPLO Reduction Forceps With Wire Guide Set (As above)

### Plate Holding/Drill Guide Forceps

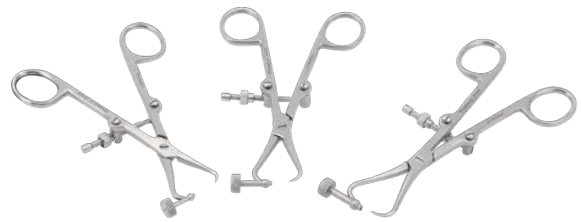

Temporary fixation of the head of TPLO plates aids in positioning, while screws are placed. The spherical ball tip of these forceps seats well in the round holes of the plate, as well as in conventional DCP holes, whilst allowing drilling through the hole. Also very useful for plate osteosynthesis in fracture repair.

**001225** 1.5mm/2.0mm Plate Holding/Drill Guide Forceps 140mm Long  
**001226** 2.4mm/2.7mm Plate Holding/Drill Guide Forceps 145mm Long  
**001227** 3.5mm Plate Holding/Drill Guide Forceps 150mm Long  
**0012SET** Plate Holding & Drill Guide Forceps Set of 3 (As above)

### Very Large Fragment Forceps



Use where a wide gape is required or where the instrument needs to be further out of the surgical field. Spinlock version is very useful during CrCl surgery for repositioning the stifle prior to placement of a lateral suture, or holding osteotomies during closing wedge type procedures.

**001202** Very Large Fragment Forceps 205mm Long  
**001203** Very Large Fragment Forceps With Spinlock 215mm Long  
**001203-L** Very Large Fragment Forceps With Spinlock Left Handed

### Delta TPLO Plate Benders With Curved Slots



Plate benders with slots tend to distort the Delta plate. The curved slots help grip & support the plate during the bending process.

**TPLODELBEND** Delta TPLO Plate Benders (Pair) 230mm Long

### Extra Long Bending Levers



Longer plate benders (240mm) with 4mm & 6mm slots are designed with TPLO plates in mind to make bending & twisting much easier.

**001288L** 3.5mm/4.5mm Extra Long Bending Levers 240mm Long

## LeiLOX CBLO Locking System



### Combines the advantages of TPLO & TTA

CBLO (CORA based leveling osteotomy) is a modern osteotomy technique to level the tibia plateau, similar to TPLO. However, CBLO addresses further challenges such as secondary (late) meniscal damage, overload of the caudal cruciate ligament, reduction of proximal anatomic axis shift & secondary translation as well as misalignment of the joint.

### Multiaxial Locking & Titanium

The screws can be locked in 90° angle with a 12° deviation in any direction. This allows you to angle the screws away from vital structures. The robust star-drive screw head can be locked firmly into the plate.

All LeiLOX CBLO Implant are made of Titanium by Rita Leibinger for the best biocompatibility.

### Anatomically Shaped Limited Contact Dynamic Compression Plates

The LeiLOX CBLO plates are contoured to match the anatomic shape of the bone. This makes it easier to place the plate in an optimal position.

The plate features limited contact dynamic compression to minimize vascular damage to the plated bone segment.

### Double Compression

Two precisely designed compression holes enable a very tight compression of the osteotomy. This allows you to use a standard cortical screw as the cranio-caudal holding screw (instead of a headless compression screw).

### Interchangeable 2.7 & 3.5mm Screws

Because the screwheads are identical, all CBLO plate sizes work with both the 2.7mm & the 3.5mm titanium CBLO screws. This offers flexibility & saves on inventory cost.

## CBLO Implant Set



The CBLO Implant Set contains:

- 1x CBLO Implant Tray
- 1x Screwrack CBLO 2.7
- 1x Screwrack CBLO 3.5
- 2x of each CBLO Plate
- 3x of each 2.7mm Cortical Screw (16-34mm)
- 3x of each 3.5mm Cortical Screw (16-34mm)
- 5x of each 2.7 Locking Screw (16-46mm)
- 5x of each 3.5 Locking Screw (16-60mm)

**CBLO142400010** CBLO Implant Set

## TPLO/CBLO Instrument Set

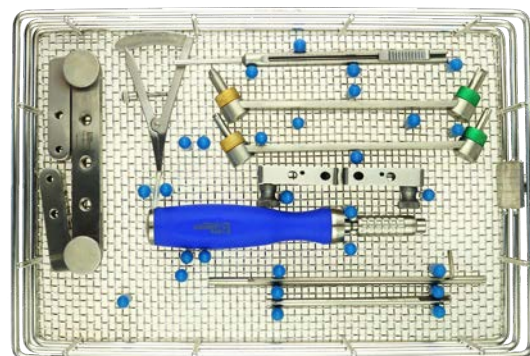

The TPLO/CBLO Instrument Set contains:

- 1x CBLO Instrument Tray
- 2x Drills (2.0 & 2.5mm)
- 3x 2 K-Wires (1.0, 2.5 & 3.0mm)
- 2x 2 Locking Drill Guides
- 2x TPLO Jigs
- 1x Screwdriver Handle
- 1x Screwdriver Shaft
- 1x Depth Gauge
- 1x Castroviejo Caliper
- 2x Compression Drill Guides

**CBLO142010001** TPLO/CBLO Instrument Set

### CBLO Plates



Titanium. Featuring both locking & compression screw holes.

- CBLOI42232710** LeiLOX CBLO Locking Plate Broad 2.7mm Left 55mm
- CBLOI42232700** LeiLOX CBLO Locking Plate Broad 2.7mm Right 55mm
- CBLOI42233510** LeiLOX CBLO Locking Plate Broad 3.5mm Left 70mm
- CBLOI42233500** LeiLOX CBLO Locking Plate Broad 3.5mm Right 70mm
- CBLOI42233560** LeiLOX CBLO Locking Plate Broad 3.5mm Left 78mm
- CBLOI42233550** LeiLOX CBLO Locking Plate Broad 3.5mm Right 78mm

### LeiLox Locking Cortical Screws 2.7mm



For LeiLOX Locking System, Star Drive T10 self-holding (T10 Shaft from Rita Leibinger needed). Self-tapping with three flute cutting edge.

- LEILOXL27STAR16** 2.7mm Leilox Titanium Locking Screw 16mm
- LEILOXL27STAR18** 2.7mm Leilox Titanium Locking Screw 18mm
- LEILOXL27STAR20** 2.7mm Leilox Titanium Locking Screw 20mm
- LEILOXL27STAR22** 2.7mm Leilox Titanium Locking Screw 22mm
- LEILOXL27STAR24** 2.7mm Leilox Titanium Locking Screw 24mm
- LEILOXL27STAR26** 2.7mm Leilox Titanium Locking Screw 26mm
- LEILOXL27STAR28** 2.7mm Leilox Titanium Locking Screw 28mm
- LEILOXL27STAR30** 2.7mm Leilox Titanium Locking Screw 30mm
- LEILOXL27STAR32** 2.7mm Leilox Titanium Locking Screw 32mm
- LEILOXL27STAR34** 2.7mm Leilox Titanium Locking Screw 34mm
- LEILOXL27STAR36** 2.7mm Leilox Titanium Locking Screw 36mm
- LEILOXL27STAR38** 2.7mm Leilox Titanium Locking Screw 38mm
- LEILOXL27STAR40** 2.7mm Leilox Titanium Locking Screw 40mm
- LEILOXL27STAR42** 2.7mm Leilox Titanium Locking Screw 42mm
- LEILOXL27STAR44** 2.7mm Leilox Titanium Locking Screw 44mm
- LEILOXL27STAR46** 2.7mm Leilox Titanium Locking Screw 46mm

### LeiLox Non Locking Cortical Screws 2.7mm



Star Drive T10. Self-holding (T10 Shaft from Rita Leibinger needed). Self-tapping with three flute cutting edge.

- LEIOXNL27STAR16** 2.7mm Leilox Titanium Non Locking Screw 16mm
- LEIOXNL27STAR18** 2.7mm Leilox Titanium Non Locking Screw 18mm
- LEIOXNL27STAR20** 2.7mm Leilox Titanium Non Locking Screw 20mm
- LEIOXNL27STAR22** 2.7mm Leilox Titanium Non Locking Screw 22mm
- LEIOXNL27STAR24** 2.7mm Leilox Titanium Non Locking Screw 24mm
- LEIOXNL27STAR26** 2.7mm Leilox Titanium Non Locking Screw 26mm
- LEIOXNL27STAR28** 2.7mm Leilox Titanium Non Locking Screw 28mm
- LEIOXNL27STAR30** 2.7mm Leilox Titanium Non Locking Screw 30mm
- LEIOXNL27STAR32** 2.7mm Leilox Titanium Non Locking Screw 32mm
- LEIOXNL27STAR34** 2.7mm Leilox Titanium Non Locking Screw 34mm

### LeiLox Locking Cortical Screws 3.5mm



For LeiLOX Locking System, Star Drive T10 self-holding (T10 Shaft from Rita Leibinger needed). Self-tapping with three flute cutting edge.

- LEILOXL35STAR16** 3.5mm Leilox Titanium Locking Screw 16mm
- LEILOXL35STAR18** 3.5mm Leilox Titanium Locking Screw 18mm
- LEILOXL35STAR20** 3.5mm Leilox Titanium Locking Screw 20mm
- LEILOXL35STAR22** 3.5mm Leilox Titanium Locking Screw 22mm
- LEILOXL35STAR24** 3.5mm Leilox Titanium Locking Screw 24mm
- LEILOXL35STAR26** 3.5mm Leilox Titanium Locking Screw 26mm
- LEILOXL35STAR28** 3.5mm Leilox Titanium Locking Screw 28mm
- LEILOXL35STAR30** 3.5mm Leilox Titanium Locking Screw 30mm
- LEILOXL35STAR32** 3.5mm Leilox Titanium Locking Screw 32mm
- LEILOXL35STAR34** 3.5mm Leilox Titanium Locking Screw 34mm
- LEILOXL35STAR36** 3.5mm Leilox Titanium Locking Screw 36mm
- LEILOXL35STAR38** 3.5mm Leilox Titanium Locking Screw 38mm
- LEILOXL35STAR40** 3.5mm Leilox Titanium Locking Screw 40mm
- LEILOXL35STAR42** 3.5mm Leilox Titanium Locking Screw 42mm
- LEILOXL35STAR44** 3.5mm Leilox Titanium Locking Screw 44mm
- LEILOXL35STAR46** 3.5mm Leilox Titanium Locking Screw 46mm
- LEILOXL35STAR48** 3.5mm Leilox Titanium Locking Screw 48mm
- LEILOXL35STAR50** 3.5mm Leilox Titanium Locking Screw 50mm
- LEILOXL35STAR52** 3.5mm Leilox Titanium Locking Screw 52mm
- LEILOXL35STAR54** 3.5mm Leilox Titanium Locking Screw 54mm
- LEILOXL35STAR56** 3.5mm Leilox Titanium Locking Screw 56mm
- LEILOXL35STAR58** 3.5mm Leilox Titanium Locking Screw 58mm
- LEILOXL35STAR60** 3.5mm Leilox Titanium Locking Screw 60mm

### LeiLox Non Locking Cortical Screws 3.5mm



Star Drive T10. Self-holding (T10 Shaft from Rita Leibinger needed). Self-tapping with three flute cutting edge.

- LEIOXNL35STAR16** 3.5mm Leilox Titanium Non Locking Screw 16mm
- LEIOXNL35STAR18** 3.5mm Leilox Titanium Non Locking Screw 18mm
- LEIOXNL35STAR20** 3.5mm Leilox Titanium Non Locking Screw 20mm
- LEIOXNL35STAR22** 3.5mm Leilox Titanium Non Locking Screw 22mm
- LEIOXNL35STAR24** 3.5mm Leilox Titanium Non Locking Screw 24mm
- LEIOXNL35STAR26** 3.5mm Leilox Titanium Non Locking Screw 26mm
- LEIOXNL35STAR28** 3.5mm Leilox Titanium Non Locking Screw 28mm
- LEIOXNL35STAR30** 3.5mm Leilox Titanium Non Locking Screw 30mm
- LEIOXNL35STAR32** 3.5mm Leilox Titanium Non Locking Screw 32mm
- LEIOXNL35STAR34** 3.5mm Leilox Titanium Non Locking Screw 34mm

### Screwdriver Shaft Star Drive T10



Self holding.

- TTARI28273510** Star-Drive Screwdriver Shaft T10 For 2.7/3.5mm Screws

### Screwdriver Handle - Silicone



Silicone. Sterilisable up to 134°C.

- TTAR247010200** Standard Screwdriver Handle AO Connection for 2.7.3.5 Screws
- LEIOXI64-2700-00** Leilox Locking Drill Guide For 2.7mm Screws
- LEIOXI64-3500-00** Leilox Locking Drill Guide For 3.5mm Screws

## Tibial Tuberosity Advancement (TTA)

To view our Surgery Guide on 'TTA', please scan the QR code below.



The TTA procedure developed by Tepic & Montavon is designed to bring the tibial plateau to sit at 90° to the straight patella ligament. This effectively neutralises the shear forces within the stifle under loading, making the stifle stable.

This is achieved by advancing the tibial tuberosity & stabilising the created defect using a titanium cage & plate. The cage is selected for both thickness & width. The implants are secured using titanium screws.

Titanium is very osteoconductive resulting in rapid healing. The use of stainless steel implants is not recommended.

### TTA Starter Kit with Forkless Plates

An alternative to the traditional forked plates. Secured using 2.4mm screws in the tibial crest, after the osteotomy & advancement have been made. Distal plate holes are secured using screws as appropriate. The rest of the technique is as per standard TTA.

Advantages:

- Position of the plate on the tibial crest & tibial diaphysis not fixed until after the osteotomy & advancement have been made – avoids difficult diaphyseal screw placement where the distal screws are too caudal on the tibia. Problem in small breeds & if this is missed in planning
- Tibial crest screws can be angled if needed
- Screw length of tibial crest screws can be individually selected for better fit
- Fewer screw holes in tibial crest than fork holes, helping reduce risk of tibial crest fracture

Full kit list is available upon request.

**TTAFLPREM** TTA Forkless Starter Kit

### TTA Starter Kit



The TTA Starter Kit includes:

#### Instruments

- TTA Drill Guide (4 Hole)
- TTA Drill Guide (8 Hole)
- TTA Fork Holder
- TTA Spreader + Inserts
- TTA Plate Bender
- TTA 2.4 Cross Head Screwdriver
- TTA Plate & Fork Overlay
- TTA Mallet
- Depth Gauge
- TTA Cage Forceps
- Block End Serrated Dissecting Forceps
- 2.5 Hex Head Screwdriver & Sleeve
- Premium Equipment Box
- 1.8mm, 2.0mm, 2.5mm Drill Bits - Hard

#### Implants

- One of each Cage (3, 4.5, 6, 7.5, 9, 10.5 & 12mm)
- One of each Fork
- One of each Plate
- 2.4mm Self Tapping Screws 12mm – 38mm 4 of each
- 2.7mm Self Tapping Screws 12mm – 28mm 3 of each
- 3.5mm Self Tapping Screws 16mm – 36mm 3 of each

Full kit list is available upon request.

**TTAPREM** TTA Starter Kit in a Premium Aluminium Box

### Premium TTA Case



Storage & autoclave case for TTA equipment & implants.

**TTABOX** Premium TTA Case (Box & Insert only)

## TTA Implants

### TTA Cages



All cage sizes are secured using 2.4mm titanium screws.

- TTAC310** Titanium TTA Cage 3 x 10mm
- TTAC313** Titanium TTA Cage 3 x 13mm
- TTAC316** Titanium TTA Cage 3 x 16mm
- TTAC4512** Titanium TTA Cage 4.5 x 12mm
- TTAC4515** Titanium TTA Cage 4.5 x 15mm
- TTAC4518** Titanium TTA Cage 4.5 x 18mm
- TTAC616** Titanium TTA Cage 6 x 16mm
- TTAC619** Titanium TTA Cage 6 x 19mm
- TTAC622** Titanium TTA Cage 6 x 22mm
- TTAC7513** Titanium TTA Cage 7.5 x 13mm
- TTAC7516** Titanium TTA Cage 7.5 x 16mm
- TTAC7519** Titanium TTA Cage 7.5 x 19mm
- TTAC919** Titanium TTA Cage 9 x 19mm
- TTAC922** Titanium TTA Cage 9 x 22mm
- TTAC925** Titanium TTA Cage 9 x 25mm
- TTAC10519** Titanium TTA Cage 10.5 x 19mm
- TTAC10522** Titanium TTA Cage 10.5 x 22mm
- TTAC10525** Titanium TTA Cage 10.5 x 25mm
- TTAC1222** Titanium TTA Cage 12 x 22mm
- TTAC1225** Titanium TTA Cage 12 x 25mm
- TTAC1228** Titanium TTA Cage 12 x 28mm
- TTAC13522** Titanium TTA Cage 13.5 x 22mm
- TTAC13525** Titanium TTA Cage 13.5 x 25mm
- TTAC13528** Titanium TTA Cage 13.5 x 28mm
- TTAC1522** Titanium TTA Cage 15 x 22mm
- TTAC1525** Titanium TTA Cage 15 x 25mm
- TTAC1528** Titanium TTA Cage 15 x 28mm
- TTAC1531** Titanium TTA Cage 15 x 31mm

### TTA Cuttable Cages



Cuttable cages can be trimmed in 3mm increments, to cover a larger range of patients with a reduced inventory.

- TTACUT316** Cuttable Cage 3 x 16mm
- TTACUT4518** Cuttable Cage 4.5 x 18mm
- TTACUT622** Cuttable Cage 6 x 22mm
- TTACUT7522** Cuttable Cage 7.5 x 22mm
- TTACUT926** Cuttable Cage 9 x 26mm
- TTACUT10526** Cuttable Cage 10.5 x 26mm
- TTACUT1228** Cuttable Cage 12 x 28mm
- TTACUT13528** Cuttable Cage 13.5 x 28mm
- TTACUT1532** Cuttable Cage 15 x 32mm
- TTACUTI** Cuttable Cage Set (9) With Free Cage Cutters
- TTACACUT** TTA Cuttable Cage Cutter

### TTA Plates



- TTAP2** Titanium TTA Plate 2 Hole
- TTAP3** Titanium TTA Plate 3 Hole
- TTAP4** Titanium TTA Plate 4 Hole
- TTAP5** Titanium TTA Plate 5 Hole
- TTAP6** Titanium TTA Plate 6 Hole
- TTAP7** Titanium TTA Plate 7 Hole
- TTAP8** Titanium TTA Plate 8 Hole

### TTA Forks

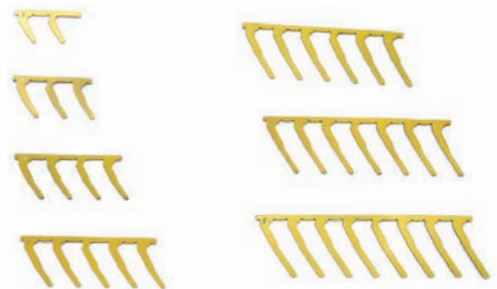

- TTAF2** Titanium TTA Fork 2 Prong
- TTAF3** Titanium TTA Fork 3 Prong
- TTAF4** Titanium TTA Fork 4 Prong
- TTAF5** Titanium TTA Fork 5 Prong
- TTAF6** Titanium TTA Fork 6 Prong
- TTAF7** Titanium TTA Fork 7 Prong
- TTAF8** Titanium TTA Fork 8 Prong

### Forkless TTA Plates

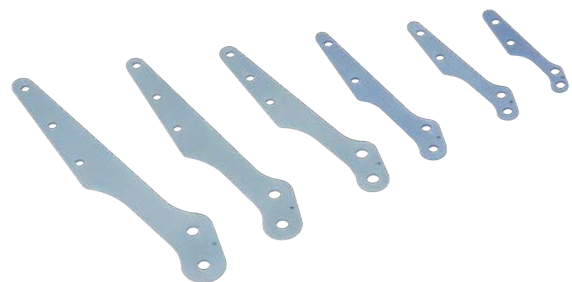

- TTAX42** Forkless TTA Plate (Same Length as TTAP3) 2.4+2.7 Screw
- TTAX52** Forkless TTA Plate (Same Length as TTAP4) 2.4+2.7 Screw
- TTAX65** Forkless TTA Plate (Same Length as TTAP5) 2.7 Screw
- TTAX78** Forkless TTA Plate (Same Length as TTAP6) 2.7+3.5 Screw
- TTAX91** Forkless TTA Plate (Same Length as TTAP7) 3.5 Screw
- TTAX104** Forkless TTA Plate (Same Length as TTAP8) 3.5 Screw
- TTAXSET** Forkless TTA Plate Set - One of Each Size

## Titanium Screws

### 2.4mm Titanium Screws - Cruciate Head

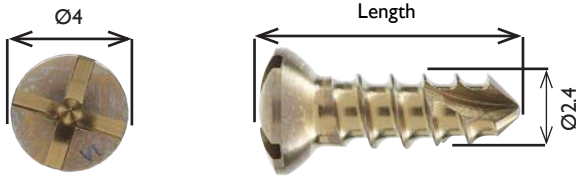

Pilot Drill - 1.8mm

<b>TICS2408</b>	Titanium 2.4mm Self Tapping Cortical Screw 8mm
<b>TICS2410</b>	Titanium 2.4mm Self Tapping Cortical Screw 10mm
<b>TICS2412</b>	Titanium 2.4mm Self Tapping Cortical Screw 12mm
<b>TICS2414</b>	Titanium 2.4mm Self Tapping Cortical Screw 14mm
<b>TICS2416</b>	Titanium 2.4mm Self Tapping Cortical Screw 16mm
<b>TICS2418</b>	Titanium 2.4mm Self Tapping Cortical Screw 18mm
<b>TICS2420</b>	Titanium 2.4mm Self Tapping Cortical Screw 20mm
<b>TICS2422</b>	Titanium 2.4mm Self Tapping Cortical Screw 22mm
<b>TICS2424</b>	Titanium 2.4mm Self Tapping Cortical Screw 24mm
<b>TICS2426</b>	Titanium 2.4mm Self Tapping Cortical Screw 26mm
<b>TICS2428</b>	Titanium 2.4mm Self Tapping Cortical Screw 28mm
<b>TICS2430</b>	Titanium 2.4mm Self Tapping Cortical Screw 30mm
<b>TICS2432</b>	Titanium 2.4mm Self Tapping Cortical Screw 32mm
<b>TICS2434</b>	Titanium 2.4mm Self Tapping Cortical Screw 34mm
<b>TICS2436</b>	Titanium 2.4mm Self Tapping Cortical Screw 36mm
<b>TICS2438</b>	Titanium 2.4mm Self Tapping Cortical Screw 38mm
<b>TICS2440</b>	Titanium 2.4mm Self Tapping Cortical Screw 40mm

### 2.7mm Titanium Screws - Hexagonal Head

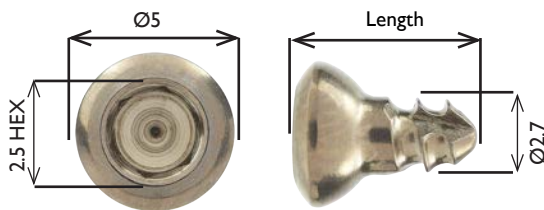

Pilot Drill - 2.0mm

<b>TICS2706</b>	Titanium 2.7mm Self Tapping Cortical Screw 6mm
<b>TICS2708</b>	Titanium 2.7mm Self Tapping Cortical Screw 8mm
<b>TICS2710</b>	Titanium 2.7mm Self Tapping Cortical Screw 10mm
<b>TICS2712</b>	Titanium 2.7mm Self Tapping Cortical Screw 12mm
<b>TICS2714</b>	Titanium 2.7mm Self Tapping Cortical Screw 14mm
<b>TICS2716</b>	Titanium 2.7mm Self Tapping Cortical Screw 16mm
<b>TICS2718</b>	Titanium 2.7mm Self Tapping Cortical Screw 18mm
<b>TICS2720</b>	Titanium 2.7mm Self Tapping Cortical Screw 20mm
<b>TICS2722</b>	Titanium 2.7mm Self Tapping Cortical Screw 22mm
<b>TICS2724</b>	Titanium 2.7mm Self Tapping Cortical Screw 24mm
<b>TICS2726</b>	Titanium 2.7mm Self Tapping Cortical Screw 26mm
<b>TICS2728</b>	Titanium 2.7mm Self Tapping Cortical Screw 28mm
<b>TICS2730</b>	Titanium 2.7mm Self Tapping Cortical Screw 30mm
<b>TICS2732</b>	Titanium 2.7mm Self Tapping Cortical Screw 32mm
<b>TICS2734</b>	Titanium 2.7mm Self Tapping Cortical Screw 34mm
<b>TICS2736</b>	Titanium 2.7mm Self Tapping Cortical Screw 36mm
<b>TICS2738</b>	Titanium 2.7mm Self Tapping Cortical Screw 38mm
<b>TICS2740</b>	Titanium 2.7mm Self Tapping Cortical Screw 40mm

### 3.5mm Titanium Screws - Hexagonal Head

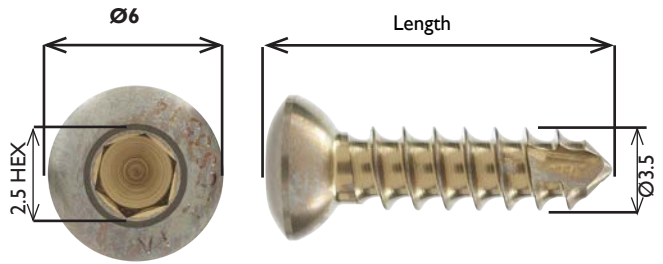

Pilot Drill - 2.5mm

<b>TICS3514</b>	Titanium 3.5mm Self Tapping Cortical Screw 14mm
<b>TICS3516</b>	Titanium 3.5mm Self Tapping Cortical Screw 16mm
<b>TICS3518</b>	Titanium 3.5mm Self Tapping Cortical Screw 18mm
<b>TICS3520</b>	Titanium 3.5mm Self Tapping Cortical Screw 20mm
<b>TICS3522</b>	Titanium 3.5mm Self Tapping Cortical Screw 22mm
<b>TICS3524</b>	Titanium 3.5mm Self Tapping Cortical Screw 24mm
<b>TICS3526</b>	Titanium 3.5mm Self Tapping Cortical Screw 26mm
<b>TICS3528</b>	Titanium 3.5mm Self Tapping Cortical Screw 28mm
<b>TICS3530</b>	Titanium 3.5mm Self Tapping Cortical Screw 30mm
<b>TICS3532</b>	Titanium 3.5mm Self Tapping Cortical Screw 32mm
<b>TICS3534</b>	Titanium 3.5mm Self Tapping Cortical Screw 34mm
<b>TICS3536</b>	Titanium 3.5mm Self Tapping Cortical Screw 36mm
<b>TICS3538</b>	Titanium 3.5mm Self Tapping Cortical Screw 38mm
<b>TICS3540</b>	Titanium 3.5mm Self Tapping Cortical Screw 40mm

### Screwbox For Titanium TTA Screws



**SHTTA242735** TTA Screwbox For 2.4mm, 2.7mm & 3.5mm Titanium Screws

### Drill Bits - Standard Length - Round Shank

	Diameter	Overall length	Flute length
<b>H090208</b>	1.8mm	110mm	25mm
<b>H090102</b>	2.0mm	110mm	30mm
<b>H090112</b>	2.5mm	120mm	30mm

### TTA Washers



Stackable titanium washers. Permit adjustments in 1mm increments.

**PW24TI** 2.4mm TTA Washer - Titanium

### TTA Spacers



Placed under either cranial or caudal cage lugs to help re-align the quadriceps mechanism in cases of concurrent patellar luxation while performing the TTA procedure. Suggested maximum tibial tuberosity movement is 50%.

<b>TTASP2</b>	TTA Spacer Titanium 2mm
<b>TTASP4</b>	TTA Spacer Titanium 4mm
<b>TTASP6</b>	TTA Spacer Titanium 6mm
<b>TTASP8</b>	TTA Spacer Titanium 8mm

### TTA Instrumentation



The TTA procedure does require some essential instruments. Positioning of the fork & cage is impossible without the following instruments.

- TTA554** TTA Drill Guide (4 Hole)
- TTA555** TTA Drill Guide (8 Hole)
- TTA666** TTA Fork Holder
- TTA444** TTA Spreader & 3mm, 6mm, 9mm, 12mm & 15mm Inserts
- TTA333** TTA Plate Bender
- TTA777** 1.9mm Pins (Set of Two)
- TTAPFO** TTA Plate & Fork Overlay
- TTATAN** Common Tangent TTA/MMT Advancement Overlay
- DG242735** Depth Gauge for 2.4/ 2.7 /3.5mm Screws

### TTA Cage Forceps



Manipulating the TTA cage into the correct position can be an awkward part of the procedure, particularly the smaller sizes. The TTA cage forceps grasp the cage firmly along the spine allowing it to be extracted from the case & placed into the tibial crest osteotomy.

**TTAFCP** TTA Cage Forceps

### Forkless Plate Forceps



Holds the plate in position allowing the pilot hole to be drilled through the guide in the correct position, even after the osteotomy has been made.

**TTAXFCP** Forkless TTA Plate Forceps (145mm)

### TTA Cuttable Cage Cutters



TTA cage cutters, which have narrow jaws designed to fit between the fins of cuttable cages. These cutters are only for TTA cages – not suitable for other implants due to the specially designed slim jaws.

**TTACACUT** TTA Cuttable Cage Cutter

### TTA Mallet



The TTA Fork needs to be gently tapped home for maximum stability. The 140 gram Mallet is the ideal weight.

**001323** Mallet 140g 155mm Long

### TTA Spinlock Reduction Forceps



Increasing repair stability & reducing healing times can be achieved by compression of the distal tibial tubercle to the tibial shaft. The spinlock reduction forceps are the right size & have the correct degree of spread for most TTA procedures.

**001245SL** TTA Spinlock Reduction Forceps 180mm

### TTA Saw Guide



The TTA saw guide is useful where the surgeon would prefer to use a guide which can be positioned correctly to maintain the position & plane of the cut, allowing concentration on the saw. Secured in place with standard fragment forceps, the guide is removed for the final freehand curve at the distal end of the osteotomy.

Suitable for both right & left leg.

**TTA999** TTA Saw Guide



## TTA Rapid Starter Kit

Instrument & selected implant set, supplied in basket-type containers with dedicated racks. Implant set contains commonly used sizes as listed below.



TTA Rapid Starter Kit contains:

TTARNEWPREMINST contents as listed below, plus:

### Implant Tray containing

6mm x 16mm Cage	x1	10.5mm x 22mm Cage	x1
7.5mm x 16mm Cage	x1	10.5mm x 25mm Cage	x1
7.5mm x 19mm Cage	x1	12mm x 22mm Cage	x1 (8 cages in total)
9mm x 19mm Cage	x1		
9mm x 22mm Cage	x1		

### Screws

1x 8mm	4x 22mm	2x 34mm
2x 10mm	4x 24mm	2x 36mm
4x 12mm	4x 26mm	2x 38mm
4x 14mm	4x 28mm	1x 40mm
4x 16mm	4x 30mm	(54 Screws in total)
4x 20mm	4x 32mm	

2x 2.5ml Nanopaste

**TTARNEWSTARTKIT** TTA Rapid Starter Kit

## TTA Rapid Premium Instrument Kit

Premium instruments kit contains:

TTAR132400013	TTA Rapid Lever-Spreader Double Ended 4mm & 6mm Broad	x1
TTAR132401013	TTA Rapid Lever-Spreader Double Ended 9mm & 12mm Broad	x1
TTAR132402000	TTA Rapid Bending Iron, Double Ended	x1
TTAR144102510	TTA Rapid K Wire Single Trochar Tip 2.5mm x 100mm	x1
TTAR148008018	TTA Rapid 1.8mm Drill Bit Round Shaft	x1
TTAR164005016	TTA Rapid Plate Holding Forceps 16cm Angled	x1
TTAR164273560	TTA Rapid Depth Gauge 150mm 60mm	x1
TTAR20342420	TTA Rapid Screwdriver Shaft for 2.4 Hex 100mm AO Fitting	x1
TTAR20346424	TTA Rapid Holding Sleeve for 2.4mm Hex Screws	x1
TTAR247010300	2mm TTA Rapid Screwdriver Handle AO Coupling	x1
TTAR164007018	TTA Rapid 1.5/1.8 Sleeve/Guide for 2.0mm & 2.4mm Screws	x1
TTAR132500010/A	TTAR Rapid Wire Box for Instruments	x1
TTAR13240400	TTA Rapid L Shape Saw Guide With Pin	x1
TTAR132404100	TTA Rapid Petite Saw Guide With Guide Pin	x1

**TTARNEWPREMINST** TTA Rapid Premium Instrument Kit

## TTA Rapid Tray with Lid



**TTAR132500000/A**

TTA Rapid Implant Tray Supplied Empty

**TTAR132500010/A**

TTA Rapid Instrument Tray Supplied Empty.

## TTA Rapid Screw Rack



TTA rapid screw rack supplied empty, available in 2 sizes.

**TTAR2103624**

TTA Rapid Screw Rack - Standard For 2.4mm Screws For 6 - 40mm in Length

**TTAR1500520**

TTA Rapid Screw Rack - 'Petite' For 2.0mm Screws For 6mm to 20mm in Length

## TTA Rapid Accessories

<b>TTAR144101010</b>	TTA Rapid K Wire Single Trochar Tip 1.2mm x 100mm
<b>TTAR144101510</b>	TTA Rapid K Wire Single Trochar Tip 1.5mm x 100mm
<b>TTAR144102510</b>	TTA Rapid K Wire Single Trochar Tip 2.5mm x 100mm
<b>TTAR148008018</b>	TTA Rapid 1.8mm Twist Drill Bit Round Shaft
<b>TTAR148008020</b>	TTA Rapid 2.0mm Drill Bit Round Shaft
<b>TTAR148008030</b>	TTA Rapid 3.0mm Drill Bit Round Shaft
<b>TTAR148008118</b>	TTA Rapid Twist Drill 1.8mm 125/ 25mm AO Shaft
<b>TTAR148008120</b>	TTA Rapid Twist Drill 2.0mm AO Shaft
<b>TTAR148012030</b>	TTA Rapid Twist Drill 3.0mm 110/ 85mm AO Shaft

## TTA Rapid - Implants TTA Rapid Cages - Standard



For use with 2.4mm TTA Rapid Screws.

- TTAR38** TTA Rapid Cage 3/8 Titanium
- TTAR310** TTA Rapid Cage 3/10 Titanium
- TTAR313** TTA Rapid Cage 3/13 Titanium
- TTAR316** TTA Rapid Cage 3/16 Titanium
- TTAR459** TTA Rapid Cage 4.5/9 Titanium
- TTAR4512** TTA Rapid Cage 4.5/12 Titanium
- TTAR4515** TTA Rapid Cage 4.5/15 Titanium
- TTAR4518** TTA Rapid Cage 4.5/18 Titanium
- TTAR613** TTA Rapid Cage 6/13 Titanium
- TTAR616** TTA Rapid Cage 6/16 Titanium
- TTAR619** TTA Rapid Cage 6/19 Titanium
- TTAR622** TTA Rapid Cage 6/22 Titanium
- TTAR7513** TTA Rapid Cage 7.5/13 Titanium
- TTAR7516** TTA Rapid Cage 7.5/16 Titanium
- TTAR7519** TTA Rapid Cage 7.5/19 Titanium
- TTAR7522** TTA Rapid Cage 7.5/22 Titanium
- TTAR916** TTA Rapid Cage 9/16 Titanium
- TTAR919** TTA Rapid Cage 9/19 Titanium
- TTAR922** TTA Rapid Cage 9/22 Titanium
- TTAR925** TTA Rapid Cage 9/25 Titanium
- TTARI0516** TTA Rapid Cage 10.5/16 Titanium
- TTARI0519** TTA Rapid Cage 10.5/19 Titanium
- TTARI0522** TTA Rapid Cage 10.5/22 Titanium
- TTARI0525** TTA Rapid Cage 10.5/25 Titanium
- TTARI219** TTA Rapid Cage 12/19 Titanium
- TTARI222** TTA Rapid Cage 12/22 Titanium
- TTARI225** TTA Rapid Cage 12/25 Titanium
- TTARI228** TTA Rapid Cage 12/28 Titanium
- TTARI3519** TTA Rapid Cage 13.5/19 Titanium
- TTARI3522** TTA Rapid Cage 13.5/22 Titanium
- TTARI3525** TTA Rapid Cage 13.5/25 Titanium
- TTARI3528** TTA Rapid Cage 13.5/28 Titanium
- TTARI519** TTA Rapid Cage 15/19 Titanium
- TTARI522** TTA Rapid Cage 15/22 Titanium
- TTARI525** TTA Rapid Cage 15/25 Titanium
- TTARI528** TTA Rapid Cage 15/28 Titanium

## TTA Rapid Acetate

- TTARACE** TTA Rapid Acetate

## TTA Rapid 2.4mm Titanium Screws - 2.0mm Hex Head

Pilot drill - 1.8mm



- TTARSC2406** TTA Rapid 2.4mm Screw Titanium 6mm
- TTARSC2408** TTA Rapid 2.4mm Screw Titanium 8mm
- TTARSC2410** TTA Rapid 2.4mm Screw Titanium 10mm
- TTARSC2412** TTA Rapid 2.4mm Screw Titanium 12mm
- TTARSC2414** TTA Rapid 2.4mm Screw Titanium 14mm
- TTARSC2416** TTA Rapid 2.4mm Screw Titanium 16mm
- TTARSC2418** TTA Rapid 2.4mm Screw Titanium 18mm
- TTARSC2420** TTA Rapid 2.4mm Screw Titanium 20mm
- TTARSC2422** TTA Rapid 2.4mm Screw Titanium 22mm
- TTARSC2424** TTA Rapid 2.4mm Screw Titanium 24mm
- TTARSC2426** TTA Rapid 2.4mm Screw Titanium 26mm
- TTARSC2428** TTA Rapid 2.4mm Screw Titanium 28mm
- TTARSC2430** TTA Rapid 2.4mm Screw Titanium 30mm
- TTARSC2432** TTA Rapid 2.4mm Screw Titanium 32mm
- TTARSC2434** TTA Rapid 2.4mm Screw Titanium 34mm
- TTARSC2436** TTA Rapid 2.4mm Screw Titanium 36mm
- TTARSC2438** TTA Rapid 2.4mm Screw Titanium 38mm
- TTARSC2440** TTA Rapid 2.4mm Screw Titanium 40mm

## TTA Rapid - Instrumentation

### TTA Rapid Bending Iron



This is used for contouring the cage ears for accurate placement & is common to the original & modified techniques. The use of other devices to create this contour is likely to result in damage to the cage ears.

- TTARI32402000** TTA Rapid Bending Iron

### TTA Rapid L-Shaped Guide



L-Shaped saw guide for the TTA Rapid technique.

- TTARI32404000.** TTA Rapid L-Shaped Saw Guide With Pin
- TTARI32403010** TTA Rapid Saw Guide Pin

### TTA Rapid Lever Spreader



These are used to open the osteotomy incrementally to the required width. The spreaders measure 1mm wider than their stated size to permit insertion of a cage beneath them.

- TTARI32400013 TTA Rapid Lever Spreader Double-Ended 3mm & 9mm Broad
- TTARI32401013 TTA Rapid Lever Spreader Double-Ended 6mm & 12mm Broad
- TTARI32401513 TTA Rapid Lever Spreader Double-Ended 13.5mm & 15mm Broad

### TTA Rapid Universal Spreader



Permits incremental opening of the osteotomy in a very controlled manner. 160mm length.

- TTARI32408016 TTA Rapid Universal Spreader

### TTA Rapid Screwdriver Handle



- TTAR247010300 2mm TTA Rapid Screwdriver Handle AO Coupling

### TTA Rapid Screwdriver Inserts



- TTAR20342420 TTA Rapid Screwdriver Insert For 2.4mm Hex Screws AO Fitting 100mm Long
- TTAR20346424 TTA Rapid Screw Holding Sleeve For 2.4mm Hex Screws

### TTA Rapid Plate Holding Forceps - Angled



Used to remove cages from implant trays.

- TTARI64005016 Plate Holding Forceps - Angled - 160mm Long

### TTA Rapid Depth Gauge



- TTARI64273560 Depth Gauge For 2.4mm Screws 150mm Long - Reads To 40mm

### TTA Rapid Drill Sleeve Guide For 2.4mm Screws



Used for accurate positioning of pilot holes for 2.4mm screws.

- TTARI64007018 TTA Rapid 1.5/1.8 Sleeve/Guide for 2.0mm & 2.4mm Screws

### Reduction Forceps With Spinlock



- 001203 Very Large Fragment Forceps With Spinlock 215mm Long
- 001245SL Large Fragment Forceps With Spinlock 180mm Long

### Plate Holding/Drill Guide Forceps



Used to snug the TTA Rapid cage ears against the medial cortex prior to drilling pilot holes.

- 001225 1.5mm/2.0mm Plate Holding/Drill Guide Forceps 140mm Long
- 001226 2.4mm/2.7mm Plate Holding/Drill Guide Forceps 145mm Long

### TTA Rapid Petite

Petite uses 2mm screws, & has dedicated instrumentation including saw guide. Petite is designed for smaller patients such as cats & smaller dogs, where 3mm advancement is sufficient but 2.4mm screws in the tibial tubercle are not appropriate.



### TTA Rapid Cages - Petite

For use with 2.0mm TTA Rapid Screws.

- TTARI32002308 TTA Rapid Cage Titanium 3/08
- TTARI32002310 TTA Rapid Cage Titanium 3/10
- TTARI32002313 TTA Rapid Cage Titanium 3/13

### TTA Rapid Screws 2.0mm Titanium - Hex Head

Pilot drill - 1.5mm

- TTARSC2006 TTA Rapid 2.0mm Screw Titanium 6mm
- TTARSC2008 TTA Rapid 2.0mm Screw Titanium 8mm
- TTARSC2010 TTA Rapid 2.0mm Screw Titanium 10mm
- TTARSC2012 TTA Rapid 2.0mm Screw Titanium 12mm
- TTARSC2014 TTA Rapid 2.0mm Screw Titanium 14mm
- TTARSC2016 TTA Rapid 2.0mm Screw Titanium 16mm
- TTARSC2018 TTA Rapid 2.0mm Screw Titanium 18mm
- TTARSC2020 TTA Rapid 2.0mm Screw Titanium 20mm
- TTARSC2022 TTA Rapid 2.0mm Screw Titanium 22mm
- TTARSC2024 TTA Rapid 2.0mm Screw Titanium 24mm
- TTARSC2026 TTA Rapid 2.0mm Screw Titanium 26mm
- TTARSC2028 TTA Rapid 2.0mm Screw Titanium 28mm
- TTARSC2030 TTA Rapid 2.0mm Screw Titanium 30mm

### TTA Rapid Petite Screwdriver Insert & Sleeve



TTAR20DRIVER TTA Rapid 2.0mm Screwdriver, Insert & Sleeve

### TTA Rapid Petite Depth Gauge



TTARI64152020 TTA Rapid Petite Depth Gauge For 2.0mm Screws

### TTA Rapid L-Shaped Petite Saw Guide



This guide is used for cage sizes 3 - 4.5mm.

TTARI32404100. TTA Rapid L-Shaped Petite Saw Guide With Pin

### TTA Rapid Petite Twist Drill

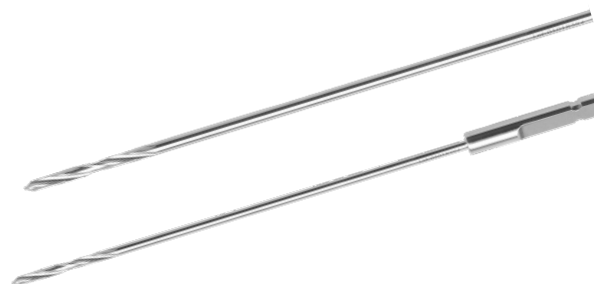

- TTARI48008015 TTA Rapid Twist Drill Bit 1.5mm Round Shaft
- TTARI48008115 TTA Rapid Twist Drill Bit 1.5mm AO Shaft

### Tiny TTAR Spreader

TTARI32-4080-08 Tiny TTAR Spreader

## Tiny TTA Rapid

Tiny TTA RAPID is designed for tiny animals – especially cats, toy dogs & dogs with short legs needing a wide advancement. The Tiny sawguide allows short osteotomies.

### Tiny TTA Rapid Set

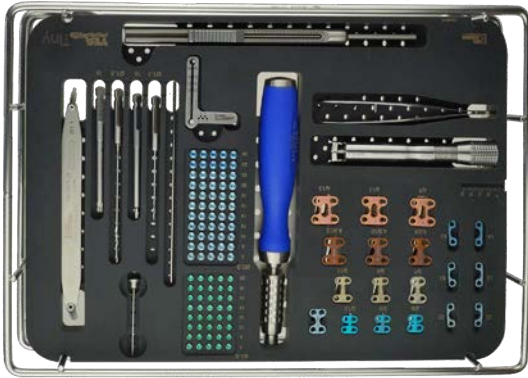

The Tiny TTA Rapid Set contains:

- 1 Sterilisation Tray with Lid
- 1 of each Tiny TTA Rapid Cage (12 total)
- 1 of each 2, 3 & 4mm Patella Spacer (6 total)
- 1 Rapid Luxation Plate Petite
- 5 of each 1.5mm Screw (6-20mm 40 total)
- 5 of each 2.0mm Screw (6-26mm 55 total)
- 1 Tibia Tappet Petite
- 1 Plate Holding Forceps
- 1 Tiny Sawguide with Pin & K-Wire
- 1 Depth Gauge
- 2 Drills (1.1 & 1.5mm)
- 2 Screwdriver Shafts (T6 & T8)
- 1 Screwdriver Handle
- 1 Drill Guide

**TTARI32650000** Tiny TTA Rapid Set

### Tiny TTA Rapid Cages



2.0mm cages use 1.5mm screws. 3.0mm cages use 1.5 or 2.0mm screws. 4.5 & 6mm cages use 2.0mm screws.

- TTAR2/6** Tiny TTA Rapid Cage 2/6 Titanium
- TTAR2/8** Tiny TTA Rapid Cage 2/8 Titanium
- TTAR2/10** Tiny TTA Rapid Cage 2/10 Titanium
- TTAR3/7** Tiny TTA Rapid Cage 3/7 Titanium
- TTAR3/9** Tiny TTA Rapid Cage 3/9 Titanium
- TTAR3/11** Tiny TTA Rapid Cage 3/11 Titanium
- TTAR45/8** Tiny TTA Rapid Cage 4/8 Titanium
- TTAR45/10** Tiny TTA Rapid Cage 4/10 Titanium
- TTAR45/12** Tiny TTA Rapid Cage 4/12 Titanium
- TTAR6/9** Tiny TTA Rapid Cage 6/9 Titanium
- TTAR6/11** Tiny TTA Rapid Cage 6/11 Titanium
- TTAR6/13** Tiny TTA Rapid Cage 6/13 Titanium

### TTA Rapid Star Drive 1.5mm Screw Titanium



Pilot drill - 1.1mm

- TTARI5STAR05** TTA Rapid Star Drive 1.5mm Screw Titanium 5mm
- TTARI5STAR06** TTA Rapid Star Drive 1.5mm Screw Titanium 6mm
- TTARI5STAR07** TTA Rapid Star Drive 1.5mm Screw Titanium 7mm
- TTARI5STAR08** TTA Rapid Star Drive 1.5mm Screw Titanium 8mm
- TTARI5STAR09** TTA Rapid Star Drive 1.5mm Screw Titanium 9mm
- TTARI5STAR10** TTA Rapid Star Drive 1.5mm Screw Titanium 10mm
- TTARI5STAR12** TTA Rapid Star Drive 1.5mm Screw Titanium 12mm
- TTARI5STAR14** TTA Rapid Star Drive 1.5mm Screw Titanium 14mm
- TTARI5STAR16** TTA Rapid Star Drive 1.5mm Screw Titanium 16mm
- TTARI5STAR18** TTA Rapid Star Drive 1.5mm Screw Titanium 18mm
- TTARI5STAR20** TTA Rapid Star Drive 1.5mm Screw Titanium 20mm

### TTA Rapid Star Drive 2.0mm Screw Titanium



Pilot drill - 1.5mm

- TTAR20STAR05** TTA Rapid Star Drive 2.0mm Screw Titanium 5mm
- TTAR20STAR06** TTA Rapid Star Drive 2.0mm Screw Titanium 6mm
- TTAR20STAR07** TTA Rapid Star Drive 2.0mm Screw Titanium 7mm
- TTAR20STAR08** TTA Rapid Star Drive 2.0mm Screw Titanium 8mm
- TTAR20STAR09** TTA Rapid Star Drive 2.0mm Screw Titanium 9mm
- TTAR20STAR10** TTA Rapid Star Drive 2.0mm Screw Titanium 10mm
- TTAR20STAR12** TTA Rapid Star Drive 2.0mm Screw Titanium 12mm
- TTAR20STAR14** TTA Rapid Star Drive 2.0mm Screw Titanium 14mm
- TTAR20STAR16** TTA Rapid Star Drive 2.0mm Screw Titanium 16mm
- TTAR20STAR18** TTA Rapid Star Drive 2.0mm Screw Titanium 18mm
- TTAR20STAR20** TTA Rapid Star Drive 2.0mm Screw Titanium 20mm
- TTAR20STAR22** TTA Rapid Star Drive 2.0mm Screw Titanium 22mm
- TTAR20STAR24** TTA Rapid Star Drive 2.0mm Screw Titanium 24mm
- TTAR20STAR26** TTA Rapid Star Drive 2.0mm Screw Titanium 26mm

### Screwdriver Shafts Star Drive



AO connection, self holding (no need for holding sleeve).

**TTARI28152015** Star-Drive T6 for 1.5mm Screws

**TTARI28152020** Star-Drive T8 for 2.0 & 2.4mm Screws

### TTA Rapid L Shape Saw Guide For Tiny Cages



**TTARI32404200** TTA Rapid L Shape Saw Guide For Tiny Cages 2 - 6mm

### Twist Drills



**TTARI48008111** Twist Drill 1.1mm AO Shaft 60mm Long

**TTARI48008011** Twist Drill 1.1mm Round Shaft 45mm Long

**TTARI48008115** Twist Drill 1.5mm AO Shaft 85mm Long

**TTARI48008015** Twist Drill 1.5mm Round Shaft 70mm Long

## Rapid Luxation Plating System

This technique is suitable for dogs which do not have a cruciate ligament rupture but suffer from a patella luxation.

Surgical protocol available on request.

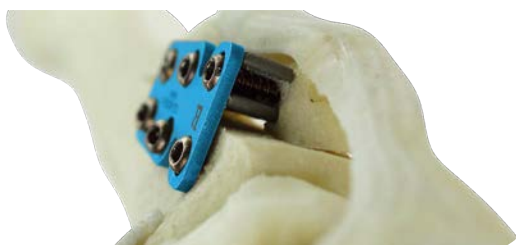

### Rapid Luxation Set



Set supplied with hex head screws.

The Rapid Luxation Set contains:

- Sterilisation Tray with Lid x1
- Each 2.0mm Screw (6-20mm) (24 in total) x3
- Each 2.4mm Screw (6-40mm) (54 in total) x3
- Each Rapid Luxation Plate (3 pieces in total) x1
- Each Patella Spacers (18 pieces in total) x1
- Large Sawguide with Pin & K-Wire x1
- Petite Sawguide with Pin & K-Wire x1
- Tibia Tappet - Petite x1
- Tibia Tappet - Standard x1
- Screwdriver Handle x1
- Screw Driver Shaft 2.4 + 2.0 with Holding Sleeve x1
- Plate Holding Forceps x1
- Depth Gauge x1
- Drill Guide x1
- Drills 1.5 & 1.8 x1

**TTARI32800000** Rapid Luxation Set

### Patella Luxation Plate - Titanium



- 132-8200-01** Rapid Luxation Plate 6 Hole Titanium 1.5mm Thick for 2.4mm Screws
- 132-8200-02** Rapid Luxation Plate 4 Hole Titanium 1mm Thick for 2.4mm Screws
- 132-8200-03** Rapid Luxation Plate Petite 4 Hole Titanium 1mm Thick for 2mm Screws

## TTA Rapid Tibial Tappet & Patellar Luxation Spacers

### Patellar Luxation in combination with TTA Rapid

When a dog suffers from a cranial cruciate ligament rupture with a simultaneous patella luxation, this can be addressed by using the Rita Leibinger Tibial Tappet and Patella Luxation Spacers during a modified TTA rapid procedure. Surgical protocol available on request.

### TTA Rapid Patellar Luxation Spacers



Patella luxation spacers are made from titanium.

- TTARI32801002L** TTA Rapid Patellar Luxation Spacer 3 Holes 2mm Height Left
- TTARI32801002R** TTA Rapid Patellar Luxation Spacer 3 Holes 2mm Height Right
- TTARI32801004L** TTA Rapid Patellar Luxation Spacer 3 Holes 4mm Height Left
- TTARI32801004R** TTA Rapid Patellar Luxation Spacer 3 Holes 4mm Height Right
- TTARI32801006L** TTA Rapid Patellar Luxation Spacer 3 Holes 6mm Height Left
- TTARI32801006R** TTA Rapid Patellar Luxation Spacer 3 Holes 6mm Height Right



- TTARI32802002L** TTA Rapid Patellar Luxation Spacer 2 Holes 2mm Height Left
- TTARI32802002R** TTA Rapid Patellar Luxation Spacer 2 Holes 2mm Height Right
- TTARI32802003L** TTA Rapid Patellar Luxation Spacer 2 Holes 3mm Height Left
- TTARI32802003R** TTA Rapid Patellar Luxation Spacer 2 Holes 3mm Height Right
- TTARI32802004L** TTA Rapid Patellar Luxation Spacer 2 Holes 4mm Height Left
- TTARI32802004R** TTA Rapid Patellar Luxation Spacer 2 Holes 4mm Height Right



- TTARI32803001L** TTA Rapid Petite Tiny Pat Lux Spacer 2 Holes 1mm Height Left
- TTARI32803001R** TTA Rapid Petite Tiny Pat Lux Spacer 2 Holes 1mm Height Right
- TTARI32803002L** TTA Rapid Petite Tiny Pat Lux Spacer 2 Holes 2mm Height Left
- TTARI32803002R** TTA Rapid Petite Tiny Pat Lux Spacer 2 Holes 2mm Height Right
- TTARI32803003L** TTA Rapid Petite Tiny Pat Lux Spacer 2 Holes 3mm Height Left
- TTARI32803003R** TTA Rapid Petite Tiny Pat Lux Spacer 2 Holes 3mm Height Right
- TTARI32803004L** TTA Rapid Petite Tiny Pat Lux Spacer 2 Holes 4mm Height Left
- TTARI32803004R** TTA Rapid Petite Tiny Pat Lux Spacer 2 Holes 4mm Height Right

### TTA Rapid Tibial Tappet



The uniquely-designed tibial tappet allows you to move the tibial tuberosity very accurately and test functionality of the new position during surgery, before fixating the screws. Once in the desired position you can fixate the patella spacers and screws.

- TTARI32407000** TTA Rapid Tibial Tappet Standard 2.4mm
- TTARI32407100** TTA Rapid Petite/Tiny Tibial Tappet 2.0mm

## Triple Tibial Osteotomy (TTO) Instrumentation

To view our Surgery Guide on 'TTO', please scan the QR code below.



Dedicated instrumentation as designed by Warrick Bruce is required to make the procedure easier and to minimise errors.

### Original TTO Instrumentation

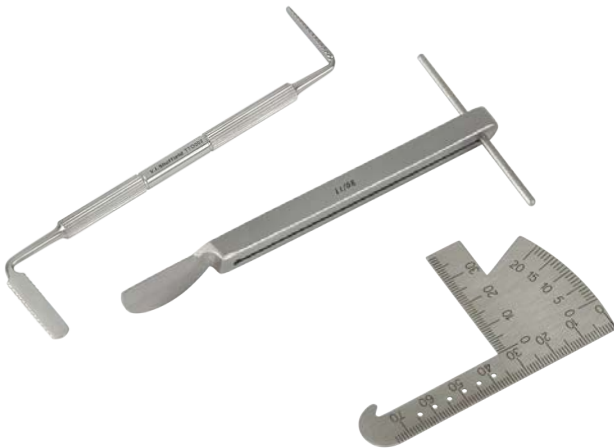

- TTO006** Basic Osteometer
- TTO004** Saw Cutting Guide (Standard 62mm)
- TTO002** Wedgie Segment Manipulator

### Revised TTO Instrumentation

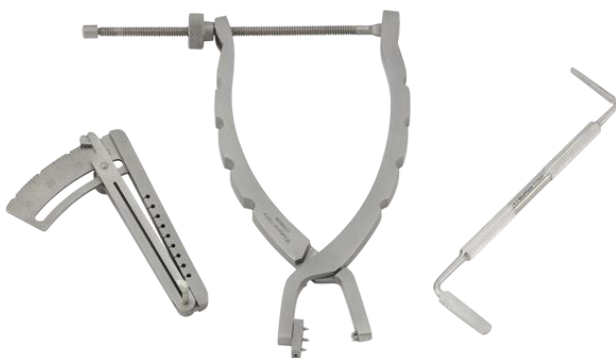

- TTO011** Combination Osteometer/Sawguide
- TTO014** TTO Clasper
- TTO002** Wedgie Segment Manipulator
- TTO009** Enhanced TTO Instrument Set (All of above)

## TTO Plates

The Standard TTO Plate is a cloverleaf TPLO Plate. Being positioned over the caudal 2/3 of the tibia the plate selected is typically a little smaller than is the case with a wedge TPLO. Use the free plate overlay for the final selection. Thicker plates are harder to contour and a selection of pre-contoured plates are available.

- TPLO202026** 2.0mm DCP 26mm Overall Length
- TPLO202031** 2.0mm DCP 31mm Overall Length
- TPLO242434** 2.4mm DCP 34mm Overall Length
- TPLO242441** 2.4mm DCP 41mm Overall Length
- TPLO272739** 2.7mm DCP 39mm Overall Length
- TPLO272745** 2.7mm DCP 45mm Overall Length
- TPLO273539** 2.7/3.5 DCP 39mm Overall Length  
Allows Use Of 3.5mm Cancellous Screw In Head
- TPLO273545** 2.7/3.5 DCP 45mm Overall Length 2.5mm Thick
- TPLO353555** 3.5mm DCP 55mm Overall Length
- TPLO353557** 3.5mm DCP 57mm Overall Length Heavy Duty
- TPLO353559** 3.5mm DCP 59mm Overall Length
- TPLO353562** 3.5mm DCP 62mm Overall Length
- TPLO353565** 3.5mm DCP 65mm Overall Length
- TPLO353577** 3.5mm DCP 77mm Overall Length
- TPLO353577X** 3.5mm DCP 77mm Overall Length Extra Shaft Hole
- TPLO353579** 3.5mm DCP 79mm Overall Length Heavy Duty
- TPLO354579** 3.5/4.5 DCP 79mm Overall Length Heavy Duty  
Allows 4.5mm Screws In Head
- TPLO35456579** 79mm Overall Length Heavy Duty  
Allows 4.5/6.5mm Screws In Head
- TPLO45659030** 4.5mm DCP 90mm Overall Length  
Will Accept 6.5mm Cancellous Screws In Head 3.0mm Thick
- TPLO45659035** 4.5mm DCP 90mm Overall Length  
Will Accept 6.5mm Cancellous Screws In Head 3.5mm Thick
- TPLO45659045** 4.5mm DCP 90mm Overall Length  
Will Accept 6.5mm Cancellous Screws In Head 4.5mm Thick
- TPLOO** Angle Finder & Plate Overlay

### Pre-Contoured TTO Plates

- TPLO353555PCR** 3.5mm Plate 55mm Overall Length Right
- TPLO353555PCL** 3.5mm Plate 55mm Overall Length Left
- TPLO353557PCR** 3.5mm Plate 57mm Overall Length Right
- TPLO353557PCL** 3.5mm Plate 57mm Overall Length Left
- TPLO353579PCR** 3.5mm Plate 79mm Overall Length Right
- TPLO353579PCL** 3.5mm Plate 79mm Overall Length Left

## Lateral Suture Starter Kits

To view our Surgery Guide on 'Lateral Suture', please scan the QR code below.



## LigaFiba® Lateral Suture With Crimp Starter Kit



The LigaFiba® Lateral Suture With Crimp Starter Kit contains:

- 091135M Compound Action Crimping Forceps for LigaFiba/12-14mm Crimps x1
- 091153 Heavy Duty Needle Driver With Tungsten Jaws x1
- LFS140TC LigaFiba Scissor 140mm 5.5" Curved Tungsten Carbide x1
- LFLSCR150 LigaFiba Lateral Suture Plus Crimp Tube (150 x 500mm) x2
- LFLSCR250 LigaFiba Lateral Suture Plus Crimp Tube (250 x 500mm) x2
- LFLSCR500 LigaFiba Lateral Suture Plus Crimp Tube (500 x 600mm) x2

The LigaFiba® Lateral Suture With Crimp Starter Kit For Smaller Breeds contains:

- 091135M Compound Action Crimping Forceps for LigaFiba/12-14mm Crimps x1
- 091153 Heavy Duty Needle Driver With Tungsten Jaws x1
- LFS140TC LigaFiba Scissor 140mm 5.5" Curved Tungsten Carbide x1
- LFLSCR75 75 LigaFiba Lateral Suture Plus Crimp Tube x2
- LFLSCR150 150 LigaFiba Lateral Suture Plus Crimp Tube x2
- LFLSCR250 250 LigaFiba Lateral Suture Plus Crimp Tube x2

- LFLSCRSTARTER** LigaFiba® Lateral Suture with Crimp Starter Kit
- LFLSCRSTARTER/S** LigaFiba® Lateral Suture with Crimp Starter Kit For Smaller Breeds

## Nylon Lateral Suture Starter Kits



This Vi Starter Kit contains:

- 091135 Crimping Forceps x1
- 091155 50lb Nylon Line with Swaged on Needle & Crimp x2
- 091156 80lb Nylon Line with Swaged on Needle & Crimp x2
- 091157 100lb Nylon Line with Swaged on Needle & Crimp x2
- 091154** CCL Suture System (Swaged on) Basic Kit Crimping Forceps 2x Each Size Nylon/Needle/Crimp Sterile Packs



This Vi Starter Kit contains:

- 091135C Compound Action Crimping Forceps x1
- 091155 50lb Nylon Line with Swaged on Needle & Crimp x2
- 091156 80lb Nylon Line with Swaged on Needle & Crimp x2
- 091157 100lb Nylon Line with Swaged on Needle & Crimp x2
- 091150** CCL Suture System (Swaged On) Compound Action Kit 2x Each Size Nylon/Needle/Crimp Sterile Packs



This Vi Starter Kit contains:

- 091135 Crimping Forceps x1
- 091153 Heavy Duty Needle Driver x1
- 091155 50lb Nylon Line with Swaged on Needle & Crimp x2
- 091156 80lb Nylon Line with Swaged on Needle & Crimp x2
- 091157 100lb Nylon Line with Swaged on Needle & Crimp x2
- 091151** CCL Suture System (Swaged On) Basic Kit Plus Forceps 2x Each Size Nylon/Needle/Crimp Sterile Packs Plus Heavy Duty Needleholders



## Lateral Suture Using LigaFiba®

### LigaFiba® Lateral Sutures

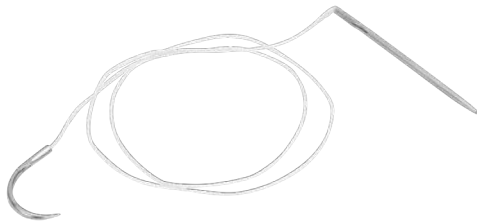

Extreme strength, minimal stretch & good abrasion-resistance characteristics make LigaFiba® an ideal material for lateral sutures. The loop may be either tied or crimped at the end of the procedure. LigaFiba® for any given diameter is more than twice as strong as monofilament nylon. Lateral sutures are supplied with size-appropriate cruciate needle on one end and a straight round bodied needle at the other. Supplied sterile.

- LFLS75** 75 LigaFiba® Lateral Suture (300mm)
- LFLS150** 150 LigaFiba® Lateral Suture (500mm)
- LFLS250** 250 LigaFiba® Lateral Suture (500mm)
- LFLS500** 500 LigaFiba® Lateral Suture (600mm)

### Double LigaFiba® Lateral Suture



Double strand presentation with no crimps. Supplied sterile.

- LFLS250D** Double 250 LigaFiba® Lateral Suture (500mm)

### LigaFiba® Lateral Sutures With Crimp

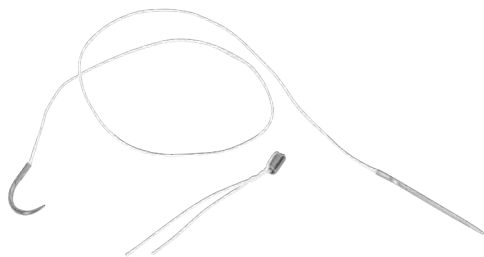

LigaFiba® does knot securely but for maximum security requires 6 throws which creates a rather bulky knot. Crimping creates a secure, low profile, radio-dense join between the free ends of LigaFiba®. To make passing the LigaFiba® through the crimp a simple process the 25mm of LigaFiba® nearest the needle has been processed to minimise fraying. Always cut the lateral suture near the needle. Supplied sterile.

- LFLSCR75** 75 LigaFiba® Lateral Suture (300mm) + Crimp
- LFLSCR150** 150 LigaFiba® Lateral Suture (500mm) + Crimp
- LFLSCR250** 250 LigaFiba® Lateral Suture (500mm) + Crimp
- LFLSCR250D** Double 250 LigaFiba® Lateral Suture (500mm) with 2 Crimps
- LFLSCR500** 500 LigaFiba® Lateral Suture (600mm) + Crimp

## LigaFiba® Scissors



LigaFiba® is so tough it is difficult to cut & will damage standard scissors. Use our special T.C. Scissors with a custom cutting edge.

- LFS140TC** LigaFiba® Scissors T.C. 145mm

## Compound Action Crimpers For LigaFiba®



The compound action crimper delivers a pre-measured crimp with minimal effort. The jaw cut-outs prevent over crimping. These crimpers require the least effort of any Vi crimper available. The compound action crimper is suitable for all crimps apart from the thin-walled 10mm crimp for 50lb nylon which suits the standard simple action crimper.

- 091135M** LigaFiba® Compound Action Crimpers 245mm

## LigaFiba® Crimps

Spare crimps for LigaFiba®. Please note that only the LigaFiba® Crimper is powerful enough for LigaFiba® Crimps.

- LFCRIMP75** Crimp for 75 LigaFiba®
- LFCRIMP150** Crimp for 150 LigaFiba®
- LFCRIMP250** Crimp for 250 LigaFiba®
- LFCRIMP500** Crimp for 500 LigaFiba®

## Lateral Suture Using Nylon

### Sterile CCL Packs

Monofilament line used as a lateral suture (De Angelis style) is an accepted CCL treatment method. Crimping is strongly recommended as the knots formed tend to be large, often causing seroma reactions & pain due to soft tissue irritation.

Packs are supplied sterile. Re-autoclaving is not recommended as this reduces the strength & increases the elasticity of the material.

Double sutures are supplied swaged on as a loop for use of the self-locking McKee/Miller knot (VCOT 1999;12:78-80) or with 2 crimps. One needle passes around the fabella allows two lines to be placed with less peri-fabellar damage.

### Sterile Leader Line + Crimp + Needle

Procedure packs containing suture, swaged on needle & crimp.



- 091155** 50lb Nylon Line x 500mm On Swaged-On V. Small Fabella Needle + 10mm Crimp (Sterile)
- 091156** 80lb Nylon Line x 800mm On Swaged-On Small Fabella Needle + 12mm Crimp (Sterile)
- 091157** 100lb Nylon Line x 800mm On Swaged-On Medium Fabella Needle + 12mm Crimp (Sterile)

### Double Leader Line + Needle + Crimps

For the application of double lines with the single pass of a needle.

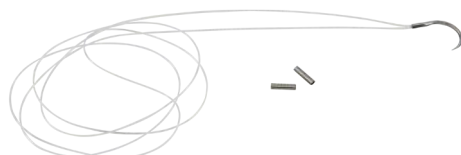

- 091165** 50lb Double Line (500mm x 2 As Loop) On V Small Fabella Needle Plus 2 x 10mm Crimps (Sterile)
- 091166** 80lb Double Line (800mm x 2 As Loop) On Small Fabella Needle Plus 2 x 12mm Crimps (Sterile)
- 091167** 100lb Double Line (800mm x 2 As Loop) On Medium Fabella Needle Plus 2 x 12mm Crimps (Sterile)



## Double Leader Line Loop on Needle

For use with McKee/Miller knot.



- 091160** 50lb Double Line (500mm x 2 As Loop) On V Small Fabella Needle
- 091161** 80lb Double Line (800mm x 2 As Loop) On Small Fabella Needle
- 091162** 100lb Double Line (800mm x 2 As Loop) On Medium Fabella Needle

## Sterile Leader Line + Crimp

For use with separate Fabella (Cruciate) Needles.



- 091142** 10mm Tube Crimp + 500mm x 50lb Nylon (Sterile Pack)
- 091137** 12mm Tube Crimp + 800mm x 80lb Nylon (Sterile Pack)
- 091147** 12mm Tube Crimp + 800mm x 100lb Nylon (Sterile Pack)



## ViPP

Through a true partnership approach, you can deliver quantifiable rewards for you and your Practice by joining our **Veterinary Instrumentation Partnership Programme.**

To find out more, scan the QR code below.



### Sterile Nylon Leader Line

Also useful for other ligament replacement procedures, e.g. hip toggle, collateral ligament repair.



- 091141 500mm x 50lb Nylon (Sterile Pack)
- 091139 800mm x 80lb Nylon (Sterile Pack)
- 091148 800mm x 100lb Nylon (Sterile Pack)

### Crimps



Crimps supplied non-sterile.

- 091140 10mm Tube Crimp for 50lb Line
- 091136 12mm Tube Crimp for 80lb + 100lb Line
- 091133 14mm Tube Crimp Suitable For Nylon Over 100lb
- 091140/10 10mm Tube Crimp For 50lb Line Pack of 10
- 091136/10 12mm Tube Crimp For 80lb+100lb Line Pack of 10
- 091133/10 14mm Tube Crimp Suitable For Nylon Over 100lb Pack of 10

### Fabella (Cruciate) Needles

Most surgeons use our sterile procedure packs which include swaged on needle & appropriate crimps. Some surgeons prefer to use non swaged on needles although do bear in mind that leader line passed through a regular needle creates more damage as it passes through the femoro-fabella ligament. It is this ligament which is relied on for the holding power of the suture. Cruciate needles will pass through a hole created with a 2.7mm bone tunnel borer into the tibial crest.



- 091144VS Fabella Needle Very Small - Pack of 6 Has Regular Eye 16mm x 1.57mm
- 091144 Fabella Needle Small - Pack of 6 Has Regular Eye 21mm x 1.58mm
- 091145 Fabella Needle Medium - Pack of 6 Has Regular Eye 27mm x 1.58mm
- 091146 Fabella Needle Large - Pack of 6 Has Regular Eye 37mm x 1.57mm

### Which line should I choose?

If a patient is above their ideal bodyweight, is particularly boisterous, or if there are concerns about post-operative compliance, a surgeon may chose to go up a size at their own discretion.

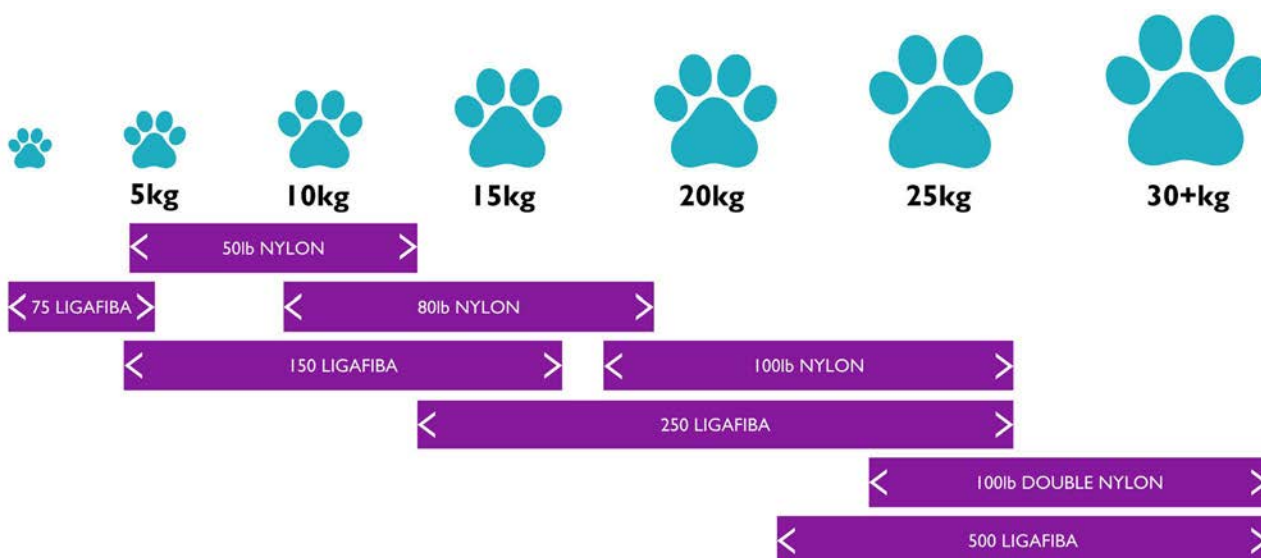

## Instrumentation For Lateral Suture

### Crimping Forceps



Basic simple action crimper for monofilament line only.

091135 Crimping Forceps 195mm Long

### Compound Action Crimper



Compound action crimper for monofilament line only, for both 10 & 12mm crimps. Delivers a more powerful crimp than the standard crimper.

091135C Compound Action Crimper 230mm Long

### Compound Action Crimpers For LigaFiba®



The compound action crimper delivers a pre-measured crimp with minimal effort. The jaw cut-outs prevent over crimping. These crimpers require the least effort of any Vi crimper available. The compound action crimper is suitable for all crimps apart from the thin walled 10mm crimp for 50lb Nylon which suits the standard simple action crimper.

091135M LigaFiba® Compound Action Crimpers 245mm

### Correct Crimping



✓ Correct.  
Three evenly spaced crimps

✗ Incorrect.  
Not enough crimps

✗ Incorrect.  
Crimps too close to end of tube

## Loop Tension Devices

Prior to crimping it is suggested that the loop be tensioned sufficiently to eliminate the anterior draw, but not enough to create an outward rotation. Many surgeons achieve this by hand but others may choose to use a tensioning device.

### CCL Tensioning Device



Simple tension device requiring a pair of standard Gelpis.

091132P CCL Tensioning Device (Pair)

### CCL Loop Tensioning



Leader line gripped by thumbscrew.

Does not require use of extra crimps - less wasteful.

Speed lock type action gives more 'feel' than ratchet type.

Jaws designed specifically for crimping system.

091132A CCL Loop Tensioner 175mm

### Lateral Suture Tension Device



Ratchet based, it relies on the jaws pulling against crimps attached to the free ends of the loop. It is simple & effective but does require two extra crimps which are ultimately discarded.

091158 Lateral Suture Tensioner 170mm

### Fixed Hande Bone Tunnel Borer



- 001070X Fixed Handle Bone Tunnel Borer 2mm
- 001071X Fixed Handle Bone Tunnel Borer 2.7mm
- 001072X Fixed Handle Bone Tunnel Borer 3.5mm
- 001073X Fixed Handle Bone Tunnel Borer 2.5mm

### LigaFiba® Scissors



LigaFiba® is so tough it is difficult to cut & will damage standard scissors. Use our special T.C. Scissors with a custom cutting edge.

LFS140TC LigaFiba® Scissors T.C. 145mm

### Heavy Duty Needle Driver



The large needles used for cruciate lateral suture placement, along with the force needed to pass them, will damage standard needleholders. A dedicated heavy duty TC needle driver kept with the cruciate kit will prove more cost effective, & improve grip on the needle.

091153 Heavy Duty Needle Driver With Tungsten Jaws 195mm Long



### Training & Education

Our **e-learning platform** delivers a variety of technical and clinical educational material, in an engaging and interactive format.

With a CPD certificate awarded upon successful completion of each module, the e-learning platform from Vi will help you to fulfil your annual CPD requirements.

Sign up today by scanning the QR code below.



## Lateral Button Suture

To view our Surgery Guide on 'Lateral Button Suture', please scan the QR code below.

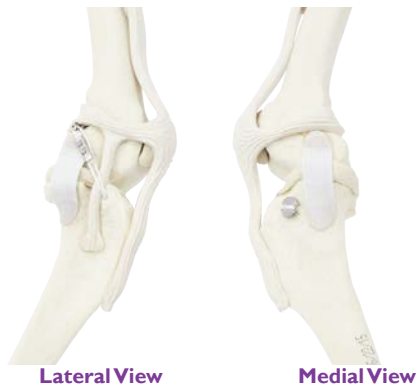

## LigaFiba® Lateral Button Suture With Crimp Starter Kit



The LigaFiba® Lateral Titanium Button Suture With Crimp Starter Kit - Standard contains:

- 091135M Compound Action Crimping Forceps for LigaFiba/12-14mm Crimps x1
- 091153 Heavy Duty Needle Driver With Tungsten Jaws x1
- LFS140TC LigaFiba Scissor 140mm 5.5" Curved Tungsten Carbide x1
- LFLBS150TI 150 LigaFiba Lateral Button Suture TI Button x2
- LFLBS250TI 250 LigaFiba Lateral Button Suture TI Button x2
- LFLBS500TI 500 LigaFiba Lateral Button Suture TI Button x2

The LigaFiba® Lateral Titanium Button Suture With Crimp Starter Kit - Small contains:

- 091135M Compound Action Crimping Forceps for LigaFiba/12-14mm Crimps x1
- 091153 Heavy Duty Needle Driver With Tungsten Jaws x1
- LFS140TC LigaFiba Scissor 140mm 5.5" Curved Tungsten Carbide x1
- LFLBS75TI 75 LigaFiba Lateral Button Suture TI Button x2
- LFLBS150TI 150 LigaFiba Lateral Button Suture TI Button x2
- LFLBS250TI 250 LigaFiba Lateral Button Suture TI Button x2

**LFLBSSTARTERTI** LigaFiba® Lateral Titanium Button Suture With Crimp Starter Kit - Standard

**LFLBSSTARTERTI/S** LigaFiba® Lateral Titanium Button Suture With Crimp Starter Kit - Small

## LigaFiba® Lateral Titanium Button Suture



- LFLBS75TI** 75 LigaFiba® Lateral Button Suture Ti Button
- LFLBS150TI.** 150 LigaFiba® Lateral Button Suture Ti Button
- LFLBS250TI.** 250 LigaFiba® Lateral Button Suture Ti Button
- LFLBS250DTI.** 250 LigaFiba® Lateral Button Suture Double/Ti Button
- LFLBS500TI.** 500 LigaFiba® Lateral Button Suture Ti Button

## Which line should I choose?

If a patient is above their ideal bodyweight, is particularly boisterous, or if there are concerns about post-operative compliance, a surgeon may choose to go up a size at their own discretion.

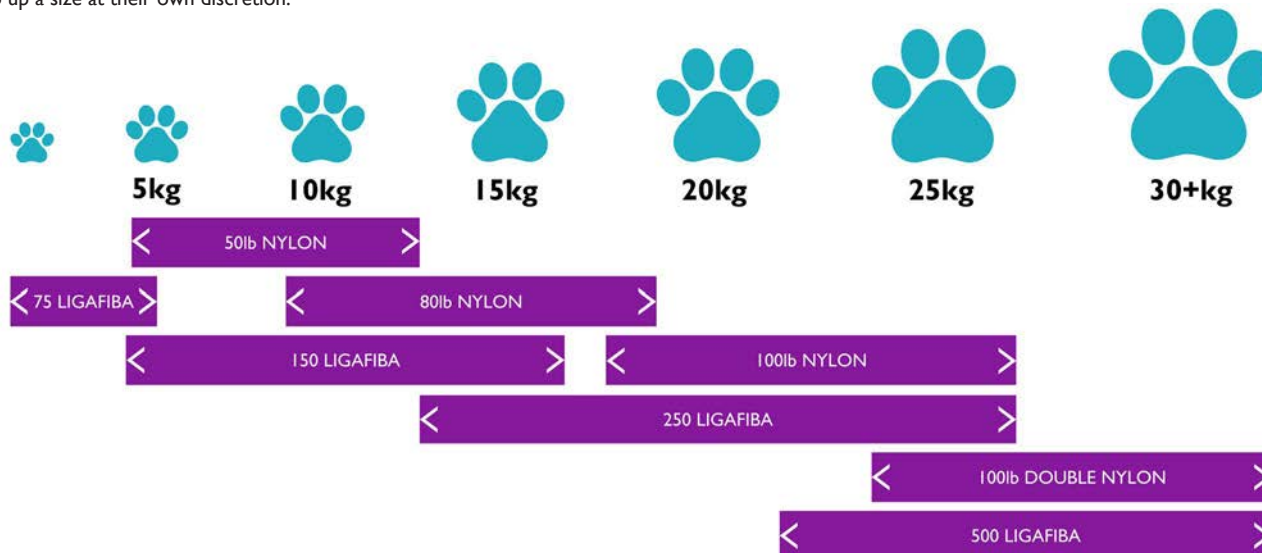

## Nylon Lateral Button Suture



- NLBS50TI** 50lb Nylon Lateral Button Suture With Titanium Button
- NLBS80TI** 80lb Nylon Lateral Button Suture With Titanium Button
- NLBS100TI** 100lb Nylon Lateral Button Suture With Titanium Button

## LigaFiba® Isotoggle

To view our Surgery Guide on 'LigaFiba® Isotoggle', please scan the QR code below.

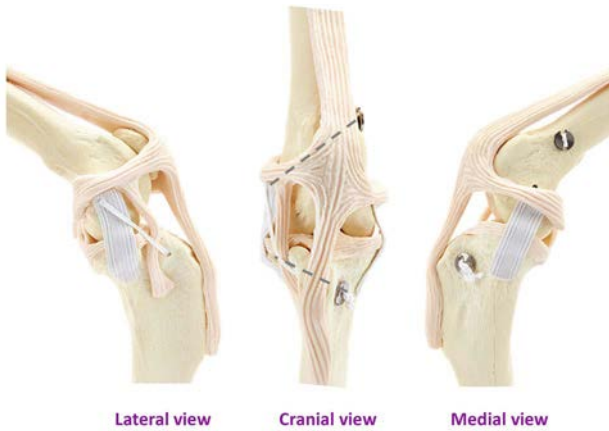

The Isotoggle suture is placed via bone tunnels across the stifle at isometric points. The use of isometric points maximises the range of movement of the stifle & protects the suture from repeated stretching & abrasion. The suture is anchored over buttons on the medial side.

- LFITS150TI** 150 Isotoggle Suture Set
- LFITS250TI** 250 Isotoggle Suture Set
- LFITS500TI** 500 Isotoggle Suture Set

## Isotoggle Aiming Device - Adjustable Drill Guide

Useful for the placement of the femoral bone tunnel which can be more challenging than the tibial tunnel. Adjustable Drill Guide with an appropriately sized drill slider may be used to pre-determine the line of the tunnel & offer protection of the soft tissues. The arms of the guide have sufficient 'spring' in them so if pre-stressed the guide is self-retaining.



- ADJDG2035** Adjustable Drill Guide 175mm
- KWG10** K-Wire Guide For ADJDG2035

## Isotoggle Consumables

### Drill Bits

- H090102AS** 2.0mm Antiskid Drill (150) 100mm
- H090112AS** 2.5mm Antiskid Drill (250) 115mm
- H090106L** 3.5mm Round Shank Drill 180mm

### Titanium Buttons



- TIBUT6H** Titanium Button 6mm 2 Holes
- TIBUT6S** Titanium Button 6mm 2 Slots
- TIBUT9H** Titanium Button 9mm 2 Holes
- TIBUT9S** Titanium Button 9mm 2 Slots
- TIBUT11H** Titanium Button 11mm 2 Holes
- TIBUT11S** Titanium Button 11mm 2 Slots

## LigaFiba® Isotoggle Interference Screw



The LigaFiba® interference screw offers an alternative to tying over a button. The screw has a tapered, soft profile thread which jams the LigaFiba® into the bone tunnel.

- LFIS253518SS** Interference Screw 3.5mm Stainless 18mm
- LFIS253518TI** Interference Screw 3.5mm Titanium 18mm
- LFIS354523SS** Interference Screw 4.5mm Stainless 23mm
- LFIS354523TI** Interference Screw 4.5mm Titanium 23mm

### Suture Screws

Suture screws are a self-tapping screw with an eyed head, designed to be used as a versatile, economic suture anchor. The thread pattern is the same as the equivalent type of cortical or cancellous screw.

Pre drill with the standard pilot for the screw size selected, screw in with the dedicated insertion tool.



The Suture Screw Set contains:

	Box and Insert for Suture Anchor Set (Not sold separately)	x1
SSITUN	Universal Insertion Tool for all Suture Screws	x1
SS2006	Suture Screw Cortical 2.0mm x 6mm	x2
SS2010	Suture Screw Cortical 2.0mm x 10mm	x2
SS2708	Suture Screw Cortical 2.7mm x 8mm	x2
SS2714	Suture Screw Cortical 2.7mm x 14mm	x2
SS3512	Suture Screw Cortical 3.5mm x 12mm	x2
SS3520	Suture Screw Cortical 3.5mm x 20mm	x2
SS4016	Suture Screw Cancellous 4.0mm x 16mm	x2
SS4024	Suture Screw Cortical 4.0mm x 24mm	x2
LF150500	LigaFiba 150 x 500mm (Sterile)	x1
LF250600	LigaFiba 250 x 600mm (Sterile)	x1
LF500600	LigaFiba 500 x 600mm (Sterile)	x1

<b>SSITKIT</b>	Suture Screw Set
<b>SS2006</b>	2.0mm Diameter 6mm Long 1.0mm Hole Cortical
<b>SS2010</b>	2.0mm Diameter 10mm Long 1.0mm Hole Cortical
<b>SS2708</b>	2.7mm Diameter 8mm Long 1.5mm Hole Cortical
<b>SS2714</b>	2.7mm Diameter 14mm Long 1.5mm Hole Cortical
<b>SS3512</b>	3.5mm Diameter 12mm Long 2.0mm Hole Cortical
<b>SS3520</b>	3.5mm Diameter 20mm Long 2.0mm Hole Cortical
<b>SS4016</b>	4.0mm Diameter 16mm Long 2.0mm Hole Cancellous
<b>SS4024</b>	4.0mm Diameter 24mm Long 2.0mm Hole Cancellous
<b>SSITUN</b>	Universal Insertion Tool For All Suture Screws

### Suture Anchor Pin

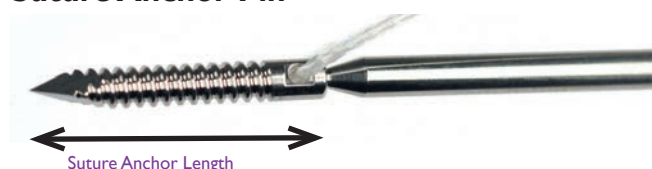

A threaded suture anchor is machined into the tip of a trochar pin. Immediately proximal to the suture anchor is a narrow break-off point. The construct is stable during axial drilling of the pin into bone. Once in position with the hole of the anchor just above the surface of the bone the shaft of the pin is rocked to & fro. The stainless steel undergoes work hardening & becomes very brittle, ultimately breaking off leaving the anchor in position ready for placement of sutures. The suture anchor pin is extremely easy to position & place without pre-drilling. Length of pin into the bone is (approx) 2.5mm - 12mm, 3.0mm - 14mm & 4.0mm - 20mm.

<b>SAP2.5</b>	Suture Anchor Pin 2.5mm Diameter 1.0mm Hole 17mm Suture Anchor Length 125mm Overall Length
<b>SAP3</b>	Suture Anchor Pin 3mm Diameter 1.0mm Hole 21mm Suture Anchor Length 127mm Overall Length
<b>SAP4</b>	Suture Anchor Pin 4mm Diameter 2.0mm Hole 26mm Suture Anchor Length 136mm Overall Length

### LigaFiba® Tendon & Ligament Sutures

LigaFiba® is available in sterile single lengths for use in conjunction with any suitable suture anchor system.

<b>LF150500</b>	150 LigaFiba® x 500mm <15kg
<b>LF250600</b>	250 LigaFiba® x 600mm 15 - 30kg
<b>LF500600</b>	500 LigaFiba® x 600mm >30kg

### Meniscus Surgery

#### Meniscus Surgery Set



Management of meniscal injuries has three phases, all of which will require special instrumentation.

- Exposure of the meniscus, particularly the caudal horn of the medial meniscus. This will require that the tibia is advanced & distracted relative to the femur
- Examination of the meniscus for lesions. A visual examination is not enough. The surface of the meniscus should be probed for defects & tears. The circumferential attachments should be checked for integrity
- Any lesions discovered must be treated/managed as appropriate

The Enhanced Meniscus Surgery Set contains:

001112	Stifle Distractor (Spread: Min. 8mm, Max 30mm)	x1
001113	Small Joint Distractor 140mm Long 6mm Wide Tips	x1
06054	Vi Fine Stainless Steel Beaver Type Scalpel Handle 130mm	x1
05905	Fine Stainless Steel Blades Sm65 (Box of 25)	x1
103180	Halstead Mosquito Forceps Straight 5" 125mm - 1/2 Teeth	x1
001048	Mini Hohman Retractor 8mm Short Tip	x1
AR-17-11X	Meniscus Push Knife Knurled Stainless Handle	x1
AR-17-19X	Meniscus Hook Knife Knurled Stainless Handle	x1
001409	2mm Meniscus Probe Nerve Hook 2mm	x1
BX221250	Stainless Steel Box 220mm x 120mm x 50mm	x1
BXSIL2212	Silicone Insert for Box 220mm x 120mm	x1

#### 001117 Enhanced Meniscus Surgery Set



The Meniscus Surgery Set contains:

001112	Stifle Distractor (Spread: Min. 8mm, Max 30mm)	x1
001408	Meniscus Probe 1mm / Nerve Hook 1mm	x1
06054	Vi Fine Stainless Steel Beaver Type Scalpel Handle 130mm	x1
05905	Fine Stainless Steel Blades Sm65 (Box of 25)	x1
103180	Halstead Mosquito Forceps Straight 5" 125mm - 1/2 Teeth	x1
001048	Mini Hohman Retractor 8mm Short Tip	x1
BX221250	Stainless Steel Box 220mm x 120mm x 50mm	x1
BXSIL2212	Silicone Insert for Box 220mm x 120mm	x1

#### 001116 Meniscus Surgery Set



## Meniscus Instrumentation

### Hook Knife & Push Knife



These three hand-held knives can deal with most meniscal tears. Their low profile makes them suitable for both open & arthroscopic surgeries.

- AR-17-19XS** Hook Knife 150mm
- AR-17-19X** Hook Knife 225mm
- AR-17-11X** Push Knife 225mm

### Stifle Lever



Exposure of the medial meniscus is never easy. Access is limited. The stifle levers are designed to fit the trochlea, while the atraumatic tip hooks behind the caudal tip of the tibial plateau. The levering action spreads the load over the surface of the trochlea, more effectively than a Hohman. Two sizes to cover most cases.

- 001115** Stifle Lever >20kg 225mm
- 001115S** Stifle Lever Small <20kg 165mm

### Arthroscopic Stifle Lever VSTL



The arthroscopic stifle lever is finer & longer than the standard version, making it more suitable for arthroscopic surgery.

The good-sized white PTFE handle has a useful notch which aligns with the tip orientation of the lever. Not just for arthroscopy – useful in open arthrotomies as well.

Developed for stifle surgery by Ian Holsworth.

- AR-17-02** Arthroscopic Stifle Lever VSTL 280mm

## Meniscus Probes

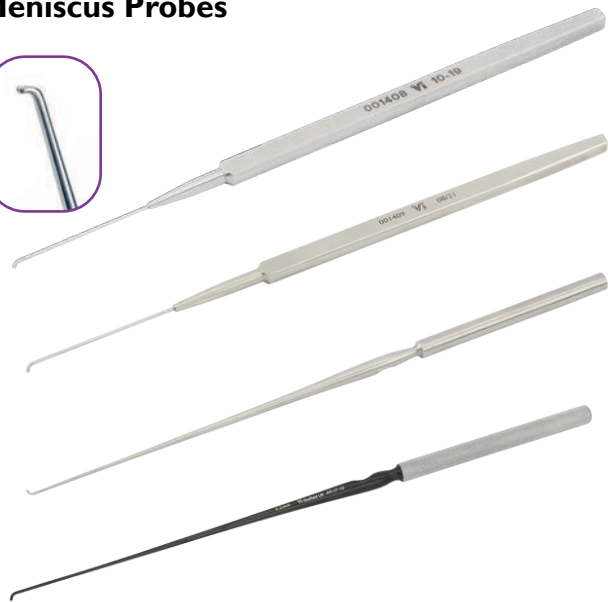

Used to probe the meniscus to check for tears, which may not be seen easily.

1mm – dogs up to 30kgs      2mm – dogs over 30kgs

- 001408** Meniscus Probe 1mm Tip 190mm
- 001409** Meniscus Probe 2mm Tip 220mm
- 001409A** Meniscus Probe 2mm Tip Heavy Pattern
- AR-17-10** Meniscus Probe 2.2mm Black Shaft For Arthroscopy 220mm

**Toothed Halsteads**



Very useful for grasping the meniscus.

- 103185 Halstead Mosquito Forceps 1/2 Teeth Cof 125mm
- 103180 Halstead Mosquito Forceps 1/2 Teeth Str 125mm

**Senn (Cats Paw) Retractor**



- 833305 Senn Retractor Sharp (Cats Paw) 160mm
- 833310 Senn Retractor Blunt (Cats Paw) 160mm

**Fat Pad Retractor**



Visualisation of the medial meniscus is maximised by retraction of the fat pad. Previously this has been achieved by use of a Senn (Cats Paw) retractor. The fat pad retractor has the same clawed foot but has a much more practical means of holding the instrument.

- 001114 Fat Pad Retractor 180mm
- 001145 Fat Pad Retractor Small 180mm



**Meniscectomy Instruments**



Purpose designed, the jaws of the Ligament Clamp have multiple small gripping teeth to combat synovial fluid slip. The T handle push knife is only sharp on the inner curve, not at the tips. Suitable for larger patients.

- 001107 Meniscectomy Knife 165mm
- 001110 Ligament/Cartilage Clamp 140mm
- 001100 Meniscectomy Instrument Set (As above)



**Loan Kits**

For a nominal fee, we have a range of **specialist loan kits** available to complement your own fleet. With next working day availability, the service offers flexibility as procedures are booked with your clients.

To find out more, scan the QR code below.



## Stifle Distractors



When closed, the tips of the Stifle Distractor overlap. This reduces the profile of the tips and minimises the chance of iatrogenic damage when inserting the device into the joint space.



Designed to separate the femoral component of the stifle from the tibia. For the best exposure, joint surfaces should move away from each other in a parallel fashion, exposing the meniscus in its natural state & minimally distorted by the examination.

### Positioning:

- One tip is placed in the intercondylar notch
- The other on the cranial intercondylar area
- Neither tip should involve articular cartilage
- Test distraction (by squeezing the handles) to find the exact point at which a full distraction will expose the meniscus
- Engage the spinlock to open the joint

**00112/L** Stifle Distractor Large Min Spread 10mm  
Max Spread 40mm 210mm Long

**00112** Stifle Distractor Min Spread 8mm Max Spread 30mm 190mm Long

**00112S** Stifle Distractor Small Min Spread 6mm Max Spread 20mm

**00112XS** Stifle Distractor Extra Small

## Small Stifle Distractor



The small distractor is also useful as small local muscle & tissue retractors in & around canine joints e.g. elbow exploration. Total length 130mm.

**00113** Small Joint Distractor/Retractor 6mm Wide Tips

## Very Small Stifle Distractor



The very small distractor is extremely useful as a small joint retractor during the meniscal release procedure. It is used to open a small window, caudal to the medial collateral. Total length 140mm.

**00113VS** V Small Joint Distractor/Retractor 3mm Wide Tips

## Miniature Stifle Distractor



Scaled-down version of the very small stifle distractor for use in small & miniature breeds. Same overlapping tip pattern shown in all Vi stifle distractors.

**00113VSX** Miniature Stifle Distractor 100mm

## Spinlock Stifle Distractor



Alternative spinlock version of the ratcheted stifle distractors. Spinlocks avoid the slippage which can occur with ratchets, & allow incremental opening of the joint which is not dependant on the tooth pitch of a ratchet.

**00113SL** Spinlock Small Stifle Distractor 140mm 6mm Tips

**00113VSSL** Spinlock Very Small Stifle Distractor 140mm 3mm Tips

### Gelpi Self Retaining Retractor



Measurement 'a' gives the depth of the tips.

Available as singles or sets of two.

- 001330** Gelpi Retractor 120mm Spread (a=20mm) 180mm Long
- 001330SL** Gelpi Retractor With Spinlock (a=20mm) 180mm Long
- 001330S** Gelpi Retractor Sharp Tips (a=20mm) 180mm Long
- 001331** Gelpi Long Reach (a=40mm) 200mm Long
- 001331L** Gelpi Very Long Reach (a=60mm) 200mm Long
- 001332** Gelpi Small 60mm Spread (a=15mm) 135mm Long
- 0013301** Gelpi Mini Flat 45mm Spread (a=15mm) 90mm Long
- 0013302** Gelpi Mini Curved 45mm Spread (a=15mm) 90mm Long
- 0013303** Gelpi Mini Curved 45mm Spread Blunt Tips 90mm Long



- 001330/2** Gelpi Retractors 120mm Spread (a=20mm) 180m Long Set of 2
- 001330SL/2** Gelpi Retractors With Spinlock(a=20mm) 180mm Long Set of 2
- 001330S/2** Gelpi Retractors Sharp Tips (a=20mm) 180mm Long Set of 2
- 001331/2** Gelpi Long Reach (a=40mm) 200mm Long - Set of 2
- 001331L/2** Gelpi Very Long Reach (a=60mm) 200mm Long - Set of 2
- 001332/2** Gelpi Small 60mm Spread (a=15mm) 135mm Long - Set of 2
- 0013301/2** Gelpi Mini Flat 45mm Spread (a=15mm) 90mm Long - Set of 2
- 0013302/2** Gelpi Mini Curved 45mm Spread (a=15mm) 90mm Long - Set of 2
- 0013303/2** Gelpi Mini Curved 45mm Spread 90mm Long Blunt Tips - Set of 2



### Small Stifle Ronguers



Small ronguers with angled slim jaws, useful for work within the stifle to remove CrCL remnants or to apply tension to meniscal tissue prior to sharp resection.

**001301** Small Stifle Ronguer 1.75mm Bite 140mm Long



### Email Marketing Service

Our marketing emails are designed to **educate**, to keep you up to date with what's new at Vi & share **exclusive offers & discounts**.

Sign up today by scanning the QR code below.



## Patellar Luxation

To view our Surgery Guide on 'Patellar Luxation' please scan the QR code below.



## Modular Osteotome With Ultra-Thin Interchangeable Blades & Diamond Rasp



PTFE osteotome handle which accepts a good range of blades plus a diamond rasp (not included in set). Blades are very thin (1.1mm) allowing fine cuts & reducing the incidence of breaking the block during block sulcoplasty procedures. Replacement T wrench & retaining screw are also available.

<b>001380</b>	Modular Osteotome With 7 Blades
<b>001382</b>	Modular Osteotome Replacement Blade 4mm
<b>001390</b>	Modular Osteotome Replacement Blade 5mm
<b>001383</b>	Modular Osteotome Replacement Blade 6mm
<b>001384</b>	Modular Osteotome Replacement Blade 8mm
<b>001385</b>	Modular Osteotome Replacement Blade 10mm
<b>001386</b>	Modular Osteotome Replacement Blade 12mm
<b>001387</b>	Modular Osteotome Replacement Blade 15mm
<b>001388</b>	Modular Osteotome Replacement Blade 20mm
<b>001389</b>	Modular Diamond Rasp 6mm
<b>001380SCREW</b>	Spare Screw For Modular Osteotome
<b>TBHEX40</b>	4.0mm T Bar Hex Driver

## Gordon Coronoid Osteotome



Originally developed for surgery on the medial coronoid, its thin, sharp blade & narrow widths are making this tool increasingly popular amongst surgeons for block sulcoplasty.

<b>AR-17-30</b>	Gordon Coronoid Osteotome 4mm
<b>AR-17-29</b>	Gordon Coronoid Osteotome 2mm

## Orthopaedic Hard Back Saw



Made from stainless steel. The stiff back helps to guide the saw.

<b>001004</b>	Orthopaedic Hard Back Saw
---------------	---------------------------

## Adjustable Bone Saw



Useful for completing/squaring off the osteotomy, this saw comes complete with five, fine chrome plated blades. Blade length is adjustable from 40mm to 100mm. Handle length 130mm. Blade length 155mm.

<b>001000</b>	Adjustable Bone Saw With 5 Fine Blades
<b>001001-A</b>	Spare Fine Blades Pack of 5 Chrome Plated
<b>001000SS-A</b>	Adjustable Saw Blade Single Sterile
<b>001002</b>	Coarse Stainless Blade

## Patella Saw



With standard sawblade including Allen Wrench 1.5mm.

<b>LEI23100590</b>	Patella Saw
<b>LEI23100520</b>	Patella Saw Replacement Blade
<b>LEI23100521</b>	Patella Saw Allen Wrench

### Universal Sulcoplasty Rasp



Double ended rasp, 210mm long. Rectangular end for adjusting block sulcoplasties, triangular end for adjusting wedge sulcoplasties. Improved tooth geometry gives more efficiency over standard rasps. Cuts on pull stroke only. The rectangular end has 2 fine & 2 medium surfaces, triangular has 2 fine surfaces.

001021 Universal Sulcoplasty Rasp 210mm Long

### Rectangular Sulcoplasty Instruments

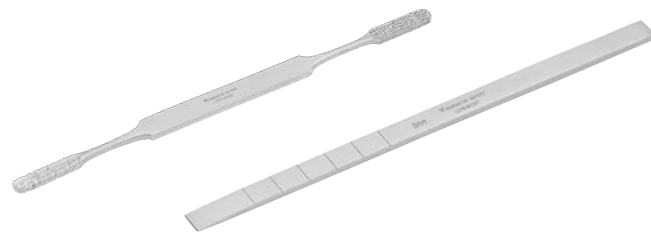

A rectangular sulcoplasty retains the maximum articular cartilage. Most standard osteotomes are too thick, tending to break up the block. The super slim 8mm osteotome minimises breakup. The rectangular rasp is designed to tidy up the corners of the sulcoplasty to maximise 'fit'.

001017 Super Slim Osteotome 8mm 180mm  
001018 Rectangular Bone Rasp 210mm

### Trochlea Rasp



Designed for deepening the trochlea groove. For larger breeds perform a wedge or block trochleaplasty using a hard backed saw. An accurately contoured trochlea is essential for a successful trochleaplasty. Articular cartilage is removed to be replaced by fibrocartilage. Total length 190mm.

001020 Trochlea Rasp 11mm max 5mm Min Diameter  
001022 Trochlea Rasp Small 8mm max 3mm Min Diameter

### Osteophyte Rasp



Most stifles requiring cruciate repair will exhibit some osteophytes. In some cases they may be bulky, necessitating removal. The osteophyte rasp is a small yet very effective rasp to keep in the cruciate set.

001019 Osteophyte Rasp

### Corrective Osteotomy Sawguide System



Corrective osteotomy is a recognised procedure in the management of patella luxation, particularly in medium & large dogs. Positioning the osteotomy at the CORA (centre of rotation) can be a challenge. Creating an accurate osteotomy at the site is a further challenge. The osteotomy & sawguide system allows the surgeon to create accurate osteotomies positioned at the correct site.

TTO011 Osteometer/Sawguide  
TTO013 Saw Guide Attachment Forceps 9½" 245mm

## Slocum Style TPO/DPO Plates

### Non-Locking & Locking

A stepped implant minimising issues relating to pelvic narrowing. The original Slocum plate was designed for 3.5mm non-locking screws with three screw holes on either side of the iliac osteotomy & a small hole on the caudal part of the plate for the addition of a cerclage wire.

Vi Slocum style TPO/DPO plates have the same layout as the original Slocum plate & are available in non-locking & locking variants. The non-locking versions feature round non-locking holes & DCP holes like the original Slocum plate. The locking version features three parallel stacked locking holes caudally (will accept cortical or locking screws), one DCP hole for compression on the cranial segment permitting osteotomy compression & two parallel stacked locking screws cranially. The caudal part of both plate styles has a hole for additional cerclage wire fixation.

## Locking Slocum Style TPO/DPO Plates

<b>09910320L</b>	Slocum Style TPO/DPO Plate 20 Left
<b>09910420R</b>	Slocum Style TPO/DPO Plate 20 Right
<b>09910525L</b>	Slocum Style TPO/DPO Plate 25 Left
<b>09910625R</b>	Slocum Style TPO/DPO Plate 25 Right
<b>09910730L</b>	Slocum Style TPO/DPO Plate 30 Left
<b>09910830R</b>	Slocum Style TPO/DPO Plate 30 Right
<b>09920320L</b>	Slocum Style TPO/DPO Plate 20 Left Locking
<b>09920420R</b>	Slocum Style TPO/DPO Plate 20 Right Locking
<b>09920625R</b>	Slocum Style TPO/DPO Plate 25 Right Locking
<b>09920830R</b>	Slocum Style TPO/DPO Plate 30 Right Locking

## Vi Locking TPO/DPO Plates

The Vi TPO/DPO plates are similar to, but have larger footprints than, the Slocum style plates. They are available in both 2.7mm & 3.5mm sizes. Both feature divergent stacked locking holes on cranial & caudal sections to maximise implant security & a compression hole on the cranial portion.



The 2.7mm plates have three screw holes cranially & caudally.

The 3.5mm plate has four holes cranially & three holes caudally.

<b>09930320L</b>	3.5mm TPO/DPO Locking Plate 20 Left
<b>09930420R</b>	3.5mm TPO/DPO Locking Plate 20 Right
<b>09930525L</b>	3.5mm TPO/DPO Locking Plate 25 Left
<b>09930625R</b>	3.5mm TPO/DPO Locking Plate 25 Right
<b>09930730L</b>	3.5mm TPO/DPO Locking Plate 30 Left
<b>09930830R</b>	3.5mm TPO/DPO Locking Plate 30 Right
<b>09940320L</b>	2.7mm TPO/DPO Locking Plate 20 Left
<b>09940420R</b>	2.7mm TPO/DPO Locking Plate 20 Right
<b>09940525L</b>	2.7mm TPO/DPO Locking Plate 25 Left
<b>09940625R</b>	2.7mm TPO/DPO Locking Plate 25 Right
<b>09940730L</b>	2.7mm TPO/DPO Locking Plate 30 Left
<b>09940830R</b>	2.7mm TPO/DPO Locking Plate 30 Right

## XL Locking Drill Guides

Extra-long locking drill-guides simplify working in deeper spaces, especially useful for TPO/DPO.



<b>LSDG2724XL</b>	2.7mm Locking Screw Drill Guide - Extra Long
<b>LSDG35XL</b>	3.5mm Locking Screw Drill Guide - Extra Long 45mm
<b>LSDG35XXL</b>	3.5mm Locking Screw Drill Guide - XXL 60mm

## Vi Twistable TPO/DPO Plates

Supplied flat to be twisted prior to surgery or supplied pre-bent to 30°, these plates offer flexibility over desired rotation & are used with non-locking screws in either 3.5mm or 4mm diameter. Neither addressing pelvic narrowing or featuring locking holes, these are being superseded by other plate designs.



<b>090167</b>	Large TPO Plate
<b>090167L30</b>	Large TPO Plate Prebent 30° Left
<b>090167R30</b>	Large TPO Plate Prebent 30° Right
<b>090179L30</b>	Small TPO Plate Prebent 30° Left
<b>090179R30</b>	Small TPO Plate Prebent 30° Right

## Hip Toggle Procedure

The hip toggle procedure is a well-established technique for the management of traumatic & unstable subluxation of the the coxo-femoral joint. Although somewhat invasive, it does have the advantage that by replacing the round ligament the hip has, postoperatively, a full range of movement.

However, the suture is placed into a very hostile abrasive environment & historically had a high failure rate. Newer materials have, to a degree, addressed this problem. LigaFiba® is spun Ultra High Molecular Weight Polyethylene. This is the same high wear material used for acetabular cups in Total Hip Replacement. For any given diameter, LigaFiba® is 2.5x stronger than the traditional monofilament nylon. In addition, the softer more flexible nature of the material allows a relatively larger implant to be passed along bone tunnels. LigaFiba® has, in addition, better wear characteristics than nylon.

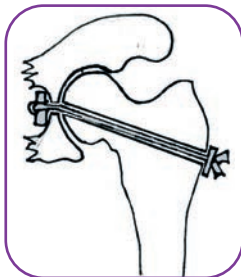

The Hip Toggle has an 'eye' to hold the suture & is made from stainless steel 316LVM. Use the Adjustable Drill Guide to accurately place the hole in the femoral neck.

All sterile packs contain a titanium button for secure fixation of the suture. Available with monofilament nylon or braided LigaFiba®. LigaFiba® is easier to work with, is stronger & ties better. However, it is a braided material with higher infection risk, so the surgeon must pay close attention to aseptic technique. We recommend the use of an anti-bacterial adhesive drape for hip toggle surgery.

## LigaFiba® Hip Toggles



<b>HIPTOGLF150TI</b>	2mm Hip Toggle c/w 150 LigaFiba®, Titanium Button - Sterile
<b>HIPTOGLF250TI</b>	3mm Hip Toggle c/w 250 LigaFiba®, Titanium Button - Sterile
<b>HIPTOGLF250MTI</b>	2.5mm Hip Toggle c/w 250 LigaFiba®, Titanium Button - Sterile
<b>HIPTOG-S</b>	80lb Nylon c/w 3mm Hip Toggle & Titanium Button
<b>HIPINTLF250</b>	HIPTOGLF250TI c/w Introducer
<b>HIPINT</b>	3mm Hip Toggle 80lb Nylon & Ormrod Button
<b>HIPTOGKITLF</b>	Contains Introducer, Hip Toggle with 250 LigaFiba® Drill Guide 3.5 & 4.5mm Drills
<b>ADJDG2035</b>	Adjustable Drill Guide 2.0, 2.5, 3.5mm Drills
<b>TOG</b>	Hip Toggle Only 3.0mm (Non Sterile)
<b>TOGM</b>	Hip Toggle Only 2.5mm (Non Sterile)
<b>TOGS</b>	Hip Toggle Only 2.0mm (Non Sterile)
<b>TIBUT6H</b>	Titanium Button 6mm 2 Holes (Non Sterile)
<b>TIBUT9H</b>	Titanium Button 9mm 2 Holes (Non Sterile)
<b>TIBUT11H</b>	Titanium Button 11mm 2 Holes (Non Sterile)

## Hip Toggle Introducer

Use of a dedicated introducer facilitates the introduction of the 3mm toggle through the acetabulum into the pelvis.

Please note, only the 3mm toggle has an introducer. An introducer is not appropriate for the smaller sizes of hip toggle as the hole drilled in the acetabulum would be proportionately too large to accommodate the introducer. An over-large hole in a smaller patient would risk iatrogenic acetabular fracture. The smaller hip toggles are therefore inserted using an artery forcep or similar.



## Notes on the use of the Hip Toggle system

1. Expose femoral head & floor of acetabulum via a cranio-lateral approach. Perform a trochanteric osteotomy if necessary
2. Clear soft tissues (mostly shredded round ligament) from acetabulum & fovea of femoral head
3. Drill a hole through the acetabular fossa (effectively the origin of the round ligament). Drill size required
  - 3mm Toggle plus 250 LigaFiba® 4.5mm drill
  - 3mm Toggle plus 80lb Nylon 4.8mm drill
  - 2.5mm Toggle plus 250 LigaFiba® 4mm drill
  - 2mm Toggle plus 150 LigaFiba® 2.7mm drill

**Points 4, 5 & 6 – please note that the insertion tool is only supplied for 3mm toggles. For toggles smaller than 3mm it is recommended to use a pair of artery forceps for insertion of the toggle.**

4. Load the toggle into the insertion tool (3mm toggle only). The 'long' end goes into the inserter tip. The suture is retained onto the inserter shaft by sliding the silicone ring over the toggle & inserter
5. Push projecting toggle into hole in acetabulum
6. Insert plunger & eject toggle into pelvic canal. Toggle should 'flip' out preventing pull out. Check toggle security
7. Drill a bone tunnel (2.5-3.5mm) from fovea exiting from proximal lateral femur
  - a. Use Adjustable Drill Guide for best results (ADJDG2035)
  - b. Visually assess positioning/drill placement
  - c. Drill from fovea to femur (requires severe external rotation of femur)
8. Pass free suture ends down the femoral neck tunnel from fovea to femur. LigaFiba® will require a suture puller or alternatively a folded loop of fine cerclage wire may be passed from lateral to medial to exit at the fovea. Pass the LigaFiba® through the loop & pull back. Check there are no soft tissues (usually joint capsule) interposed between head & acetabulum
9. Pass ends of the suture through holes in titanium button, pull tight & tie temporarily. Check that coxo-femoral joint has a full range of movement. Tie securely over button. Over-tightening is a technical error & will result in premature failure of the suture

Note: The implant always breaks within a few weeks of placement regardless of technique & material. The toggle provides temporary stability only. If it becomes necessary to remove the suture, locate the titanium button & remove both button & suture. It is not possible to retrieve the toggle which, lying extra-articularly, does not cause a problem. Complications/failure with the Hip Toggle system may be higher in giant breed dogs.



## Hohman Retractors

A simple but multi-functional instrument, with a wide number of variations to cover different procedures, patients & surgeons' requirements.

### Hohman Retractors With Short Tips 18mm & 12mm Blades



001041

These are the archetypal Hohman Retractors often described in text-books as 'Hohman'.

The 'standard' Hohman retractor shape & size.

Larger version at 240mm long is useful in larger dogs over about 20kg where more force is required for manipulation, & there may be more depth of overlying tissue.

Smaller version, 175mm long, is scaled down & useful in slightly smaller dogs or in smaller bones where less force is needed. Good for retracting fascia lata in CrCl procedures.

**001041** Hohman Retractor 18mm Short Narrow Tip Total Length 240mm

**001042** Hohman Retractor 12mm Short Narrow Tip Total Length 175mm

### Mini Hohman 6mm & 8mm Blade With Short Tip



Ideal for careful retraction of soft tissue during the manipulation of smaller bones & fragments, aiding reduction of soft tissue devascularisation. Also allows delicate retraction of soft tissue for screw & wire placement.

8mm version is particularly good for long bones in the cat.

**001047** Mini Hohman Retractor 6mm Short Tip 165mm Long

**001048** Mini Hohman Retractor 8mm Short Tip 165mm Long

### Micro Hohman 4mm With Short Narrow Tip



The smallest Hohman that Vi supply. Useful in very small procedures or patients. Also available in a version with a long narrow shaft to use with arthroscopic portals.

**001049** Micro Hohman Retractor 4mm Short Tip 160mm Long

**001049A** Micro Hohman Retractor 4mm Short Tip  
With Narrow Shaft For Arthroscopy 160mm Long

### Hohman Retractor Broad With Short Narrow Tip



001045

Broad blade Hohman provides more effective retraction of large muscle masses than the standard version, with less focal pressure.

**001045** Hohman Retractor 48mm Short Narrow Tip 260mm Long

**001046** Hohman Retractor 24mm Short Narrow Tip 185mm Long

### Hohman Retractor With Long Broad Tip



001043

Useful in & around the shoulder joint & other retraction situations when a blunt tip is desirable.

**001043** Hohman Retractor 24mm Long Broad Tip 280mm Long

**001044** Hohman Retractor 18mm Long Broad Tip 175mm Long

### Mini Hohman Broad Blade with Narrow Tip



Suggested uses: Improving visualisation of & access to mid-diaphysis of cat & small dog bones & displacing ligaments & tendons in carpus/tarsus of larger patients.

**001040** Mini Hohman 15mm Broad Blade 120mm Long

### Retractors designed specifically for use in & around the Hip Joint

Hohman retractors designed specifically for veterinary hip surgery, to deal with the muscle bulk involved

### Swan-Neck Hohman



Used for elevation & exposure of the femoral neck & head in medium/large dogs. Cranked shape keeps the surgeon's hand & the femur out of the surgical field.

**001034** Medium Swan-Neck Hohman 11mm Blade Short Tip 220mm Long

### Hip Hohman



Developed for use in Total Hip Replacement but useful in any procedure requiring elevation of the femoral head. Multiple small teeth at the end lip of the instrument sit securely on the femoral neck outside the zone of articular cartilage.

Three sizes are available. Approximate guidelines are as follows:

Large	>30kg
Medium	10-30kg
Small	<10kg

- 001038 Large Hip Hohman 255mm Long 25mm Wide Blade
- 001037 Medium Hip Hohman 175mm Long 13mm Wide Blade
- 001036 Small Hip Hohman 125mm Long 8mm Wide Blade
- 001030SET Hip Hohman Set of 3 (As above)

### Hohman Retractor 20mm Wide With Short Kinked Tip



Designed for femoral neck retraction for THR after the femoral head has been removed, in order to visualise the acetabulum for acetabular reaming. The bent tip of the Hohman is engaged caudoventral to the acetabulum with the osteotomised surface of the femoral neck behind it, & then the Hohman is retracted to pull the femoral neck out of the way of the reamer.

- 001039 Hohman 20mm Wide With Short Kinked Tip 200mm Long

### OCD Curette



Loose flaps of cartilage at the OCD lesion must be removed. The double ended OCD curette is designed to perform this task within the limited space available. Healthy fibrocartilage within the lesion should not be disturbed.

- 001030 OCD Curette 215mm Long
- 001032 OCD Curette Small 180mm Long

### Combination Bone Rasp Set



The three interchangeable rasp blades offer a range of cutting surfaces, flat, round & 'putti' style. The handle has an ergonomic design which is easy to grip even when wet.

- 001015 Combination Bone Rasp With 3 Interchangeable Heads

### Gigli



- 001515 Pair of Gigli Saw Handles



- 001514 Pair of Handles For Gigli Wire
- 001516 Gigli Saw 300mm
- 001517 Gigli Saw 500mm
- 001518 Gigli Wire Passer
- 001519 Gigli Wire Spool 10m

### Goniometers

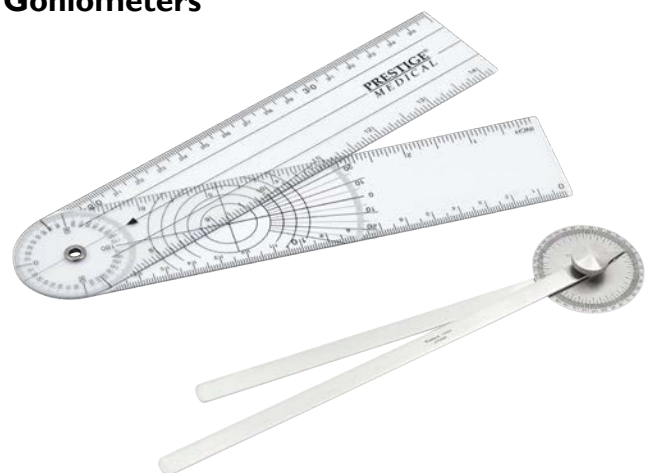

- HE-GONIO Femoral Neck Goniometer
- GONIO Goniometer 150mm
- GONIO2 Goniometer 300mm
- GONIO3 Goniometer 340mm

## Femoral Head & Neck Excision Arthroplasty Excision Arthroplasty Rasp



Designed specifically to remove any bone spurs following excision arthroplasty. Failure to remove bone spurs is the most common cause of problems with this procedure. Teeth cut on the back stroke.

**001010** Excision Arthroplasty Rasp 170mm Long

## Disarticulator



Disarticulator designed to elevate the femoral head for excision. Notch at the tip of the instrument engages & ruptures the Teres (round) ligament, which can be very difficult. Also useful in manipulation for the humeral head in OCD lesion procedures & investigation of elbow lesions.

**001090** Small Disarticulator 145mm Long  
**001091** Large Disarticulator 195mm Long

## Hatt Spoon



Alternative to the 'chip fork' style disarticulator, particularly for larger dogs. Spoon edge is sharp. Good-sized handle with a finer shaft for better balance.

**001092** Hatt Spoon 230mm (17mm x 30mm Scoop)  
**001093** Hatt Spoon 230mm (12mm x 18mm Scoop)  
**001094** Hatt Spoon 230mm (7mm x 12mm Scoop)  
**00109SET** Hatt Spoon Set of 3 (As above)



## Training & Education

Our **e-learning platform** delivers a variety of technical and clinical educational material, in an engaging and interactive format.

With a CPD certificate awarded upon successful completion of each module, the e-learning platform from Vi will help you to fulfil your annual CPD requirements.

Sign up today by scanning the QR code below.



## Arthroscopic Instrumentation

### Arthroscopy Hand Instrument Set



Set of three arthroscopy instruments for examination & intra-articular surgery. The two hand held knives can deal with most meniscal tears, whilst the black shaft of the hook probe minimises reflection.

Arthroscopy Set Contains:

AR-17-19X

AR-17-11X

AR-17-10

- AR-17-SET** Arthroscopy Hand Instrument Set
- AR-17-19X** Meniscus Hook Knife Blade Knurled Stainless Handle
- AR-17-19XS** 3mm Meniscus Hook Knife Blade Knurled Stainless Handle 150mm
- AR-17-11X** Push Knife
- AR-17-10** Hook Probe 2.2mm, With Stainless Handle Black Shaft

### External Stifle Distractor



Developed originally for arthroscopic use but also useful in open surgery on very tight osteoarthritic stifles. Improves visibility in the joint by reducing clutter.

- AR-17-01** Arthroscopic Distractor 2.5mm Pins 80mm
- AR-17-01/TPLO** Arthroscopic Distractor 3.2mm Pins 80mm

### Arthroscopic Stifle Lever VSTL



The arthroscopic stifle lever is finer & longer than the standard version, making it more suitable for arthroscopic surgery.

The good-sized white PTFE handle has a useful notch which aligns with the tip orientation of the lever. Not just for arthroscopy – useful in open arthrotomies as well.

Developed for stifle surgery by Ian Holsworth.

- AR-17-02** Arthroscopic Stifle Lever VSTL 280mm

## Arthroscopic Hand Instruments

### Hook Probe



- AR-17-09S** Hook Probe 2.2mm With Silicon Handle

### Banana Knife



- AR-17-05S** Banana Knife 2.7mm, with Silicon Handle

### Curette



- AR-17-06S** Curette 2.7mm Curved With Silicon Handle

### Ring Curette



- AR-17-07S** Ring Curette 2.7mm Small With Silicon Handle

### Smilie Knife



- AR-17-11S** Smilie Knife 2.7mm With Silicon Handle

### Hook Knife



- AR-17-19S** Hook Knife 2.7mm With Silicon Handle

### Arthroscopic Hohman Retractor



001049A Arthroscopic Hohman 4mm

### Milling Drill Designed by Van Ryssen & Van Bree



This hand-driven bur allows curettage of both cartilage & bone through the smallest working cannula. Much cheaper & easier than shaver systems.

I-17-822 Milling Drill For Arthroscopy Complete OD: 2.2mm WL: 12cm  
I-17-821 Replacement Bur & Shaft

### Gordon Coronoid Osteotome



Designed & developed by Ian Holsworth, this narrow osteotome is used for arthroscopic sub-total coronoidectomies.

AR-17-30 Gordon Coronoid Osteotome 4mm  
AR-17-29 Gordon Coronoid Osteotome 2mm

### 2.7mm Instruments

2.7mm Instruments - working length 12cm with overstraining protection.

### Alligator Grasping Forceps



AS-17-662 Alligator Grasping Forceps With Ratchet OD: 2.7mm

### Universal Rongeur & Grasping Forceps



AS-17-632 Universal Rongeur & Grasping Forceps Fenestrated OD: 2.7mm

### Biopsy & Spoon



AS-17-641 Biopsy & Spoon OD: 2.7mm

### Shoulder Aiming Device

Developed & tested at the Veterinary Faculty of Vienna, Austria by Dr Lehman.



Due to the dense muscle mass in shoulder joints, creating a puncture for a working cannula is often quite difficult. If a clean puncture allowing access directly to the joint is not achieved the first time, the risk of a subsynovial oedema increases greatly.

The shoulder puncture system has been specifically designed to help eliminate this risk.

S140-2438F Aiming Device By Dr Lehman For The Canine Shoulder For 2.4mm Scope T140-2432 & Changing Rod I-17-028

### Cannula Sets



I-17-755 Working Cannula Set 'Shoulder & Elbow' Designed By VAN BREE D:2.3 / 2.9 / 3.5mm; WL:3.5-5cm & 7-8 cm, Includes Sharp Trochar & Changing Rod

I-17-500 Working Cannula Set 'elbow' Designed By VAN BREE Consist of 3 Cannulas D:2.3/2.9/3.5mm; WL:3.5-5cm. Includes 1 Sharp Trochar & 1 Changing Rod (2.3mm)



I-18-518 Egress Cannula, With Sharp Trochar Stopcock ID 2.7mm WL 7cm

### Hand Pressure Infusion Cuffs



AR-08-100 Pressure Infusion Cuff For 500-1000ml Complete With Pressure Gauge & Hand Pump Reusable

### Puddle Vac



PV9321 Puddle Vac Pack of 5

### Camera Covers

DE-10-25 Camera Cover Disp Polyethylene 13 x 235cm Sterile Pack of 30  
DE-10-25-SINGLE Single Camera Cover Disposable 13 x 235cm Sterile

## HELICA

Surgeons contemplating use of the Helica system must attend a recognised training course.

### Helica Total Hip Instrumentation



**HE-KIT** Helica Instrument Kit

### Ancillary Helica Instrumentation

Three instruments, not included in the standard sets, make osteotomy & alignment of the femoral stem significantly easier & are recommended. The Meyerding is a very powerful hand-held retractor.

Refer to page 72 for Hip Hohman. The goniometer helps the surgeon to establish the correct axis for the femoral stem at an angle of 145 to 147 degrees.



- 001038** Helica Hohman Large
- 001037** Helica Hohman Medium
- 001036** Helica Hohman Small
- 0010300SET** Helica Hohman Set of 3 (As above)
- HE-GONIO** Helica Goniometer
- I50019** Meyerding Retractor

### Helica Drill Guide



This drill guide was modified by Christoph Stork, DipECVS, as an aid to drilling of the femoral neck during the Helica total hip joint replacement. In essence, this is an over-sized soft-tissue protector with a very large bore of 9mm accepting the largest of the drill-bits used in this procedure.

**HELICADG** Helica Drill Guide 9mm Diameter Bore

### Helica Total Hip Implants

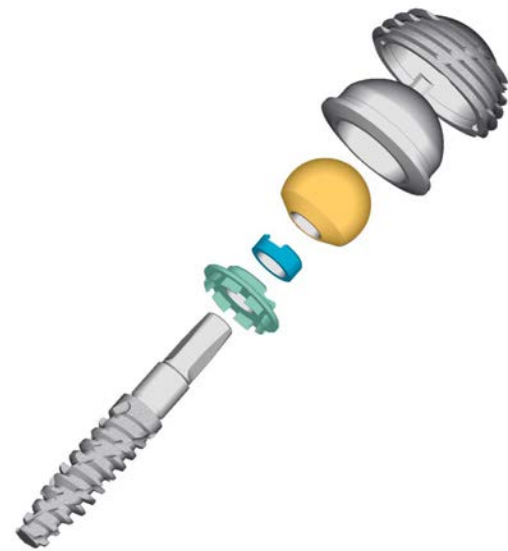

### Helica Screw Acetabular Cups

- HE-HCI-T22** Helica 22mm Acetabular Cup
- HE-HCI-T26** Helica 26mm Acetabular Cup
- HE-HCI-T28** Helica 28mm Acetabular Cup
- HE-HCI-T30** Helica 30mm Acetabular Cup
- HE-HCI-T32** Helica 32mm Acetabular Cup

### Helica TPS Stems

- HE-HS4-T0831** Helica TPS SL Stem 8x31mm
- HE-HS4-T0932** Helica TPS SL Stem 9x32mm
- HE-HS4-T1035** Helica TPS SL Stem 10x35mm
- HE-HS4-T1137** Helica TPS SL Stem 11x37mm
- HE-HS4-T-11X41** Helica TPS SL Stem, Titan 11x41mm
- HE-HS4-T1239** Helica TPS SL Stem 12x39mm

## Helica TPS Flanges

<b>HE-HF3-T18.5</b>	Helica TPS Flange and Locking Nut 18.5mm
<b>HE-HF3-T20</b>	Helica TPS Flange and Locking Nut 20.0mm
<b>HE-HF3-T22</b>	Helica TPS Flange and Locking Nut 21.5mm

## Helica TPS Locking Nut

<b>HE-HN3-T08</b>	TPS Helica Locking Nut (For Replacement)
-------------------	--

## Helica Femoral Heads

<b>HE-FHI-18S</b>	Helica 18mm Femoral Head - Short
<b>HE-FHI-18M</b>	Helica 18mm Femoral Head - Medium
<b>HE-FHI-18L</b>	Helica 18mm Femoral Head - Long
<b>HE-FHI-18XL</b>	Helica 18mm Femoral Head - Extra Long
<b>HE-FHI-18XXL</b>	Helica 18mm Femoral Head - XX Long

## Inlay Options for Screw Cup

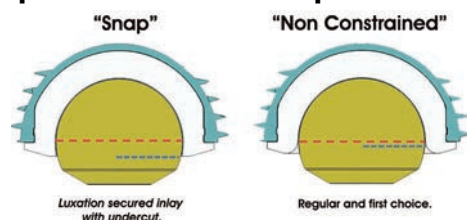

The standard inlay for the screw cup for use with Helica stems is non-constrained. Certain cases which for reasons of conformation or soft tissue benefit from a 'Snap Inlay' which is retentive.

## Helica Inlays Constrained

<b>HE-ALI-P22</b>	Helica 22mm Inlay
<b>HE-ALI-P24</b>	Helica 24mm Inlay
<b>HE-ALI-P26</b>	Helica 26mm Inlay
<b>HE-ALI-P28</b>	Helica 28mm Inlay
<b>HE-ALI-P30</b>	Helica 30mm Inlay
<b>HE-ALI-P32</b>	Helica 32mm Inlay

## Helica Inlays Non-Constrained

<b>HE-ALI-P24-NC</b>	Helica 24mm Inlay Non Constrained
<b>HE-ALI-P26-NC</b>	Helica 26mm Inlay Non Constrained
<b>HE-ALI-P28-NC</b>	Helica 28mm Inlay Non Constrained
<b>HE-ALI-P30-NC</b>	Helica 30mm Inlay Non Constrained

## Helica Hybrid Revision Implants

<b>HE-FHB-18-0</b>	Helica Hybrid 18mm Femoral Head Biometric Shank + 0
<b>HE-FHB-18-3</b>	Helica Hybrid 18mm Femoral Head Biometric Shank + 3
<b>HE-FHB-18-6</b>	Helica Hybrid 18mm Femoral Head Biometric Shank + 6
<b>HE-FHK-18XS</b>	Helica Hybrid 18mm Femoral Head Kyon Extra Short
<b>HE-FHK-18S</b>	Helica Hybrid 18mm Femoral Head Kyon Short
<b>HE-FHK-18M</b>	Helica Hybrid 18mm Femoral Head Kyon Medium
<b>HE-FHK-18L</b>	Helica Hybrid 18mm Femoral Head Kyon Long
<b>HE-FHK-18XL</b>	Helica Hybrid 18mm Femoral Head Kyon Extra Long

## 3CON Stems

<b>TS1-C-04</b>	3CON Stem # 4
<b>TS1-C-05</b>	3CON Stem # 5
<b>TS1-C-06</b>	3CON Stem # 6
<b>HE-TS1-C-07</b>	3CON Stem # 7



## CemtA Stems

<b>HE-CS1-C-04</b>	CemtA Stem	#4
<b>HE-CS1-C-05</b>	CemtA Stem	#5
<b>HE-CS1-C-06</b>	CemtA Stem	#6
<b>HE-CS1-C-07</b>	CemtA Stem	#7
<b>HE-CS1-C-08</b>	CemtA Stem	#8

## CemtA Cups

<b>HE-CCI-P-21</b>	CemtA Cup 21mm
<b>HE-CCI-P-23</b>	CemtA Cup 23mm
<b>HE-CCI-P-25</b>	CemtA Cup 25mm
<b>HE-CCI-P-27</b>	CemtA Cup 27mm
<b>HE-CCI-P-29</b>	CemtA Cup 29mm

## 15mm Femoral Heads

<b>HE-FHI-S-15-S</b>	15mm Femoral Head Small
<b>HE-FHI-S-15-M</b>	15mm Femoral Head Medium
<b>HE-FHI-S-15-L</b>	15mm Femoral Head Large
<b>HE-FHI-S-15-XL</b>	15mm Femoral Head Extra Large
<b>HE-FHI-S15-XXL</b>	15mm Femoral Head Extra Extra Large

## Cement Restrictor

<b>HE-CRI-P-01</b>	Cement Restrictor Size 1
<b>HE-CRI-P-02</b>	Cement Restrictor Size 2

## Hip Fixation & Navigation Device



During Total Hip Replacement procedure, correct placement of the acetabular cup is essential.

This navigation device gently positions the patient & includes an orientation guide to ensure the correct inclination & retroversion angles are maintained.

The blue handle allows easy rotation of the table to aid comfortable positioning, reducing the risk of stress on the spine.

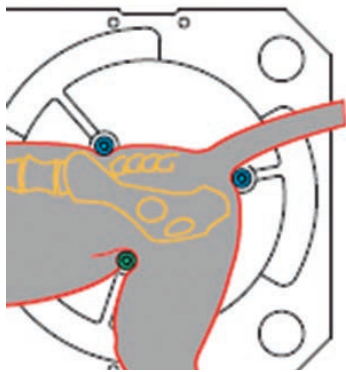

Construction is of titanium & high-strength aluminium, for easy cleaning & maintenance.

When not in use, the table can be disassembled for storage.

The two halves of the table feature slots for all components, clipping together for secure storage between uses.

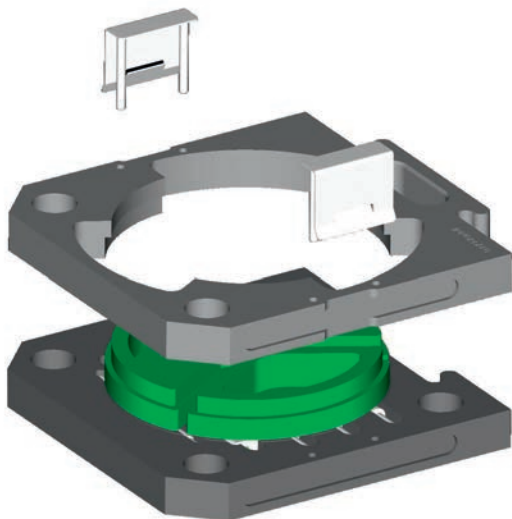
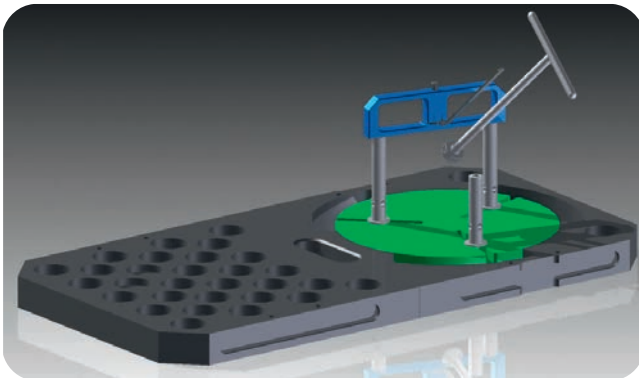

HE-HFN-KS-01 Hip Fixation & Navigation Device

## Bone Cement

### DePuy CMW Bone Cement

Designed for Total Hip Replacement. CMW is the industry standard. Also useful in stabilisation of vertebral fractures/luxations.

CMW1 is a medium/high viscosity cement for digital application.

CMW2 is a rapid set cement suitable for the acetabular cup via digital application.

CMW3 is a more fluid cement which is more appropriate for the femoral component. It is usually applied via a 50ml syringe.

CMW cement comes impregnated with Gentamycin which minimises post operative infection.



- I60500 CMW1 With Gentamycin 20g
- I60501 CMW2 With Gentamycin 20g
- I60503 CMW3 With Gentamycin 20g
- I60504 CMW3 With Gentamycin 40g

### Veterinary Instrumentation Bone Cement



- BC1 High Viscosity 20g
- BC1G High Viscosity 20g With Gentamycin
- BC3G Low Viscosity (Syringe) 20g With Gentamycin



# Internal Fixation



To view the Internal Fixation section of our website, please scan the QR code.





**SurgX** FABRICANT  
D'IMPLANTS  
VÉTÉRINAIRES

Exclusively available at



**Veterinary**  
Instrumentation

We are delighted to introduce our new and exclusive partnership with Surg'X.

Surg'X offers the first angle-stable, anatomical titanium veterinary interlocking nail for the treatment of long bone fractures in small animals. Interlocking nails are the gold standard in human long-bone trauma, thanks to their biological and mechanical advantages over plates.

## Implant and Instrument Sets

### Cats and Small Dogs - Implant Set

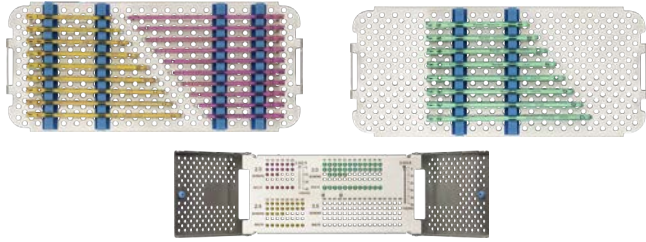

Image for illustration purposes only. Correct contents of kit shown below:

The Cats and Small Dogs Implant Set includes:

- 18 most commonly used nail sizes
- 63 locking screws (2 to 3 per size)
- 26 bolts (1 per size)
- 3 sterilization containers, 2 modular trays and 1 screw rack

**SXIS000110** Surg'X Interlocking Nail Small Starter Implant Set

### Medium and Large Dogs - Implant Set

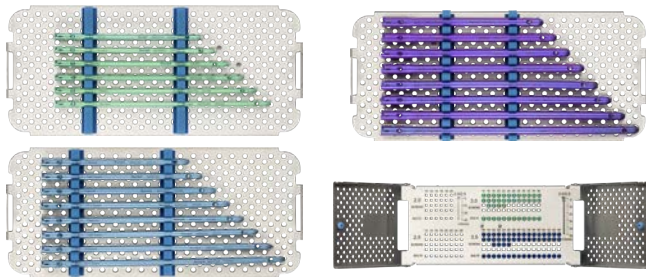

Image for illustration purposes only. Correct contents of kit shown below:

The Medium and Large Dogs Implant Set includes:

- 13 most commonly used nail sizes
- 64 locking screws (2 to 3 per size)
- 28 bolts (1 per size)
- 4 sterilization containers, 3 modular trays and 1 screw rack

**SXIS000210** Surg'X Interlocking Nail Med/Large Starter Implant Set

### Cats and Dogs All Sizes - Implant Set

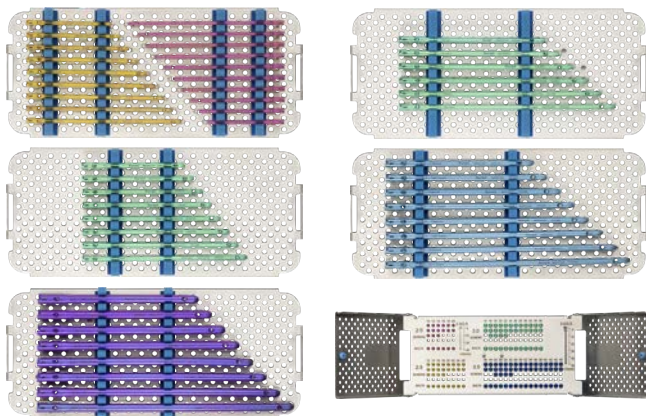

Image for illustration purposes only. Correct contents of kit shown below:

The Cats and Dogs All Sizes Implant Set includes:

- 29 most commonly used nail sizes
- 99 locking screws (2 to 3 per size)
- 42 bolts (1 per size)
- 6 sterilization containers, 5 modular trays and 1 screw rack

**SXIS000310** Surg'X Interlocking Nail All Size Starter Implant Set

### Cats and Small Dogs - Instrument Set

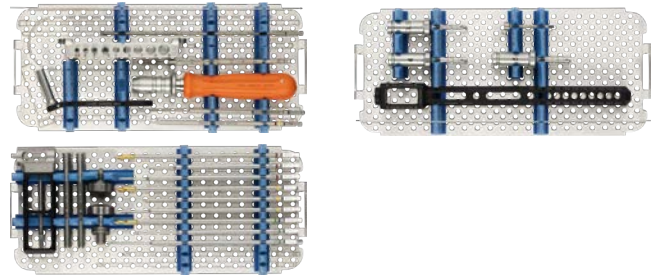

The Cats and Small Dogs Instrument Set includes:

- 41 Instruments for nails 3.5 / 4 / 5
- 2 common instrument trays
- 1 Cats & Small Dogs instrument tray
- 2 sterilization containers

**SXAS000120** Surg'X Small Instrument Set

### Medium and Large Dogs - Instrument Set

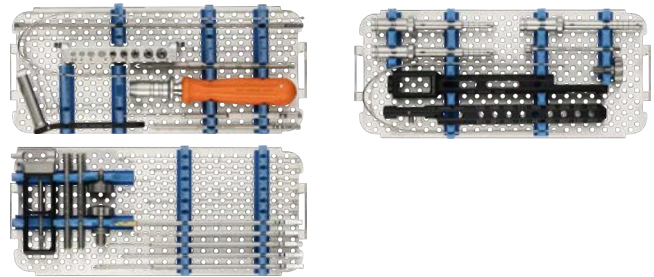

The Medium and Large Dogs Instrument Set includes:

- 37 Instruments for nails
- 2 Common instrument trays
- 1 Medium & Large Dogs instrument tray
- 2 sterilization containers

**SXAS000220** Surg'X Med/Large Instrument Set

### Cats and Dogs All Sizes - Instrument Set

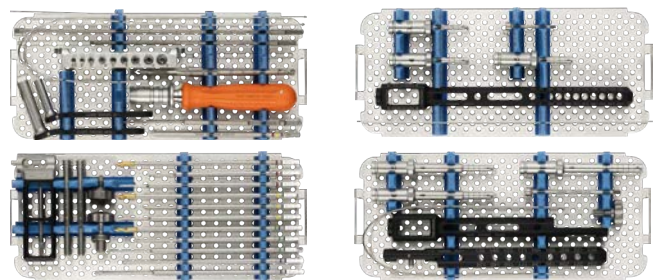

The Cats and Dogs All Sizes Instrument Set includes:

- 61 Instruments for nails
- 2 Common instrument trays
- 1 Cats & Small Dogs instrument tray
- 1 Medium & Large Dogs instrument tray
- 3 sterilization containers

**SXAS000310** Surg'X All Size Instrument Set

## Interlocking Nails

### 3.5mm Interlocking Nail



This nail is suitable for cats and small dogs.

<b>SXIN35070</b>	3.5mm Interlocking Nail 70mm
<b>SXIN35078</b>	3.5mm Interlocking Nail 78mm
<b>SXIN35086</b>	3.5mm Interlocking Nail 86mm
<b>SXIN35094</b>	3.5mm Interlocking Nail 94mm
<b>SXIN35102</b>	3.5mm Interlocking Nail 102mm
<b>SXIN35110</b>	3.5mm Interlocking Nail 110mm
<b>SXIN35118</b>	3.5mm Interlocking Nail 118mm
<b>SXIN35126</b>	3.5mm Interlocking Nail 126mm
<b>SXIN35134</b>	3.5mm Interlocking Nail 134mm
<b>SXIN35142</b>	3.5mm Interlocking Nail 142mm

### 4mm Interlocking Nail



This nail is suitable for cats and small dogs.

<b>SXIN40078</b>	4mm Interlocking Nail 78mm
<b>SXIN40086</b>	4mm Interlocking Nail 86mm
<b>SXIN40094</b>	4mm Interlocking Nail 94mm
<b>SXIN40102</b>	4mm Interlocking Nail 102mm
<b>SXIN40110</b>	4mm Interlocking Nail 110mm
<b>SXIN40118</b>	4mm Interlocking Nail 118mm
<b>SXIN40126</b>	4mm Interlocking Nail 126mm
<b>SXIN40134</b>	4mm Interlocking Nail 134mm
<b>SXIN40142</b>	4mm Interlocking Nail 142mm

### 5mm Interlocking Nail

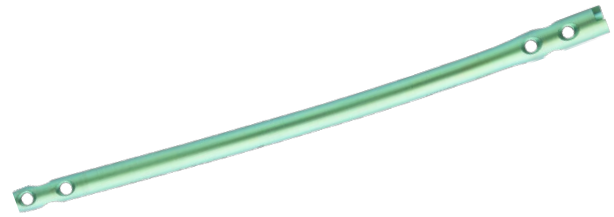

The Short 5mm nail is suitable for cats and small dogs, with the longer 5mm nails suitable for Medium and Large Dogs

<b>SXIN50094S</b>	5mm Interlocking Nail Short 94mm
<b>SXIN50102S</b>	5mm Interlocking Nail Short 102mm
<b>SXIN50110S</b>	5mm Interlocking Nail Short 110mm
<b>SXIN50118S</b>	5mm Interlocking Nail Short 118mm
<b>SXIN50126S</b>	5mm Interlocking Nail Short 126mm
<b>SXIN50134S</b>	5mm Interlocking Nail Short 134mm
<b>SXIN50142S</b>	5mm Interlocking Nail Short 142mm
<b>SXIN50150S</b>	5mm Interlocking Nail Short 150mm
<b>SXIN50134</b>	5mm Interlocking Nail 134mm
<b>SXIN50146</b>	5mm Interlocking Nail 146.5mm
<b>SXIN50159</b>	5mm Interlocking Nail 159mm
<b>SXIN50171</b>	5mm Interlocking Nail 171.5mm
<b>SXIN50184</b>	5mm Interlocking Nail 184mm
<b>SXIN50196</b>	5mm Interlocking Nail 196.5mm

### 6mm Interlocking Nail



This nail is suitable for medium and large dogs.

<b>SXIN60134</b>	6mm Interlocking Nail 134mm
<b>SXIN60146</b>	6mm Interlocking Nail 146.5mm
<b>SXIN60159</b>	6mm Interlocking Nail 159mm
<b>SXIN60171</b>	6mm Interlocking Nail 171.5mm
<b>SXIN60184</b>	6mm Interlocking Nail 184mm
<b>SXIN60196</b>	6mm Interlocking Nail 196.5mm
<b>SXIN60209</b>	6mm Interlocking Nail 209mm
<b>SXIN60221</b>	6mm Interlocking Nail 221.5mm

### 8mm Interlocking Nail

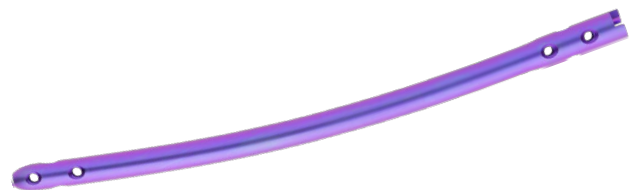

This nail is suitable for medium and large dogs.

<b>SXIN80146</b>	8mm Interlocking Nail 146.5mm
<b>SXIN80159</b>	8mm Interlocking Nail 159mm
<b>SXIN80171</b>	8mm Interlocking Nail 171.5mm
<b>SXIN80184</b>	8mm Interlocking Nail 184mm
<b>SXIN80196</b>	8mm Interlocking Nail 196.5mm
<b>SXIN80209</b>	8mm Interlocking Nail 209mm
<b>SXIN80221</b>	8mm Interlocking Nail 221.5mm
<b>SXIN80234</b>	8mm Interlocking Nail 234mm

Acetates are available to download from Vi website.  
These must be printed to scale.

## Interlocking Screws

### 2mm Interlocking Screw



Compatible with 3.5mm Interlocking Nail

<b>SXSC2010</b>	2mm Interlocking Screw 10mm
<b>SXSC2012</b>	2mm Interlocking Screw 12mm
<b>SXSC2014</b>	2mm Interlocking Screw 14mm
<b>SXSC2016</b>	2mm Interlocking Screw 16mm
<b>SXSC2018</b>	2mm Interlocking Screw 18mm
<b>SXSC2020</b>	2mm Interlocking Screw 20mm

### 2.5mm Interlocking Screw



Compatible with 4.0mm Interlocking Nail

<b>SXSC2512</b>	2.5mm Interlocking Screw 12mm
<b>SXSC2514</b>	2.5mm Interlocking Screw 14mm
<b>SXSC2516</b>	2.5mm Interlocking Screw 16mm
<b>SXSC2518</b>	2.5mm Interlocking Screw 18mm
<b>SXSC2520</b>	2.5mm Interlocking Screw 20mm
<b>SXSC2522</b>	2.5mm Interlocking Screw 22mm
<b>SXSC2524</b>	2.5mm Interlocking Screw 24mm
<b>SXSC2526</b>	2.5mm Interlocking Screw 26mm

### 3mm Interlocking Screw

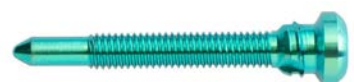

Compatible with 5.0mm Interlocking Nail

<b>SXSC3014</b>	3mm Interlocking Screw 14mm
<b>SXSC3016</b>	3mm Interlocking Screw 16mm
<b>SXSC3018</b>	3mm Interlocking Screw 18mm
<b>SXSC3020</b>	3mm Interlocking Screw 20mm
<b>SXSC3022</b>	3mm Interlocking Screw 22mm
<b>SXSC3024</b>	3mm Interlocking Screw 24mm
<b>SXSC3026</b>	3mm Interlocking Screw 26mm
<b>SXSC3028</b>	3mm Interlocking Screw 28mm
<b>SXSC3030</b>	3mm Interlocking Screw 30mm
<b>SXSC3032</b>	3mm Interlocking Screw 32mm
<b>SXSC3034</b>	3mm Interlocking Screw 34mm
<b>SXSC3036</b>	3mm Interlocking Screw 36mm

### 3.5mm Interlocking Screw



Compatible with 6.0/8.0mm Interlocking Nail

<b>SXSC3516</b>	3.5mm Interlocking Screw 16mm
<b>SXSC3518</b>	3.5mm Interlocking Screw 18mm
<b>SXSC3520</b>	3.5mm Interlocking Screw 20mm
<b>SXSC3522</b>	3.5mm Interlocking Screw 22mm
<b>SXSC3524</b>	3.5mm Interlocking Screw 24mm
<b>SXSC3526</b>	3.5mm Interlocking Screw 26mm
<b>SXSC3528</b>	3.5mm Interlocking Screw 28mm
<b>SXSC3530</b>	3.5mm Interlocking Screw 30mm
<b>SXSC3532</b>	3.5mm Interlocking Screw 32mm
<b>SXSC3534</b>	3.5mm Interlocking Screw 34mm
<b>SXSC3536</b>	3.5mm Interlocking Screw 36mm
<b>SXSC3538</b>	3.5mm Interlocking Screw 38mm
<b>SXSC3540</b>	3.5mm Interlocking Screw 40mm
<b>SXSC3542</b>	3.5mm Interlocking Screw 42mm
<b>SXSC3545</b>	3.5mm Interlocking Screw 45mm
<b>SXSC3548</b>	3.5mm Interlocking Screw 48mm

## Interlocking Bolts

### 2mm Interlocking Bolt



Compatible with 3.5mm Interlocking Nail

<b>SXB2010</b>	2mm Interlocking Bolt 10mm
<b>SXB2012</b>	2mm Interlocking Bolt 12mm
<b>SXB2014</b>	2mm Interlocking Bolt 14mm
<b>SXB2016</b>	2mm Interlocking Bolt 16mm
<b>SXB2018</b>	2mm Interlocking Bolt 18mm
<b>SXB2020</b>	2mm Interlocking Bolt 20mm

### 2.5mm Interlocking Bolt



Compatible with 4.0mm Interlocking Nail

<b>SXB2512</b>	2.5mm Interlocking Bolt 12mm
<b>SXB2514</b>	2.5mm Interlocking Bolt 14mm
<b>SXB2516</b>	2.5mm Interlocking Bolt 16mm
<b>SXB2518</b>	2.5mm Interlocking Bolt 18mm
<b>SXB2520</b>	2.5mm Interlocking Bolt 20mm
<b>SXB2522</b>	2.5mm Interlocking Bolt 22mm
<b>SXB2524</b>	2.5mm Interlocking Bolt 24mm
<b>SXB2526</b>	2.5mm Interlocking Bolt 26mm

### 3mm Interlocking Bolt



Compatible with 5.0mm Interlocking Nail

<b>SXB3014</b>	3mm Interlocking Bolt 14mm
<b>SXB3016</b>	3mm Interlocking Bolt 16mm
<b>SXB3018</b>	3mm Interlocking Bolt 18mm
<b>SXB3020</b>	3mm Interlocking Bolt 20mm
<b>SXB3022</b>	3mm Interlocking Bolt 22mm
<b>SXB3024</b>	3mm Interlocking Bolt 24mm
<b>SXB3026</b>	3mm Interlocking Bolt 26mm
<b>SXB3028</b>	3mm Interlocking Bolt 28mm
<b>SXB3030</b>	3mm Interlocking Bolt 30mm
<b>SXB3032</b>	3mm Interlocking Bolt 32mm
<b>SXB3034</b>	3mm Interlocking Bolt 34mm
<b>SXB3036</b>	3mm Interlocking Bolt 36mm

### 3.5mm Interlocking Bolt



Compatible with 6.0/8.0mm Interlocking Nail

<b>SXB3516</b>	3.5mm Interlocking Bolt 16mm
<b>SXB3518</b>	3.5mm Interlocking Bolt 18mm
<b>SXB3520</b>	3.5mm Interlocking Bolt 20mm
<b>SXB3522</b>	3.5mm Interlocking Bolt 22mm
<b>SXB3524</b>	3.5mm Interlocking Bolt 24mm
<b>SXB3526</b>	3.5mm Interlocking Bolt 26mm
<b>SXB3528</b>	3.5mm Interlocking Bolt 28mm
<b>SXB3530</b>	3.5mm Interlocking Bolt 30mm
<b>SXB3532</b>	3.5mm Interlocking Bolt 32mm
<b>SXB3534</b>	3.5mm Interlocking Bolt 34mm
<b>SXB3536</b>	3.5mm Interlocking Bolt 36mm
<b>SXB3538</b>	3.5mm Interlocking Bolt 38mm
<b>SXB3540</b>	3.5mm Interlocking Bolt 40mm
<b>SXB3542</b>	3.5mm Interlocking Bolt 42mm
<b>SXB3545</b>	3.5mm Interlocking Bolt 45mm
<b>SXB3548</b>	3.5mm Interlocking Bolt 48mm

**Drill Bits**

**Surgical Drill Bit CIS-Cortex**



- SXDB24C**
- SXDB3C**
- SXDB4C**

Surg'X Drill Bit Red Band CIS-Cortex 2.4mm  
 Surg'X Drill Bit Yellow Band CIS-Cortex 3mm  
 Surg'X Drill Bit Green & Blue Band CIS-Cortex 4mm

**Surgical Drill Bit TRANS-Cortex**



- SXDB15T1**
- SXDB15T2**
- SXDB2T1**
- SXDB2T2**
- SXDB24T1**
- SXDB24T2**
- SXDB28T1**
- SXDB28T2**

Surg'X Drill Bit Red Band TRANS-Cortex 1.5mm Size 1  
 Surg'X Drill Bit Red Band TRANS-Cortex 1.5mm Size 2  
 Surg'X Drill Bit Yellow Band TRANS-Cortex 2mm Size 1  
 Surg'X Drill Bit Yellow Band TRANS-Cortex 2mm Size 2  
 Surg'X Drill Bit Green Band TRANS-Cortex 2.4mm Size 1  
 Surg'X Drill Bit Green Band TRANS-Cortex 2.4mm Size 2  
 Surg'X Drill Bit Green Band TRANS-Cortex 2.8mm Size 1  
 Surg'X Drill Bit Green Band TRANS-Cortex 2.8mm Size 2

**SurgX** FABRICANT  
 D'IMPLANTS  
 VÉTÉRINAIRES



**Loan Kits**

For a nominal fee, we have a range of **specialist loan kits** available to complement your own fleet. With next working day availability, the service offers flexibility as procedures are booked with your clients.

To find out more, scan the QR code below.



## Plating Kits In Modular Plating Box (MPB) Concept

To view our Surgery Guide on 'The Essentials of Fracture Management' please scan the QR code below.



### Locking Plate & Screw Kit



Our MPB locking kits contain plates, screws & required instrumentation.

- LS15STARDLPKITALLMPB** 1.5mm Locking Screw Star Head & DLP Plate Kit in MPB
- LS20STARDLPKITALLMPB** 2.0mm Locking Screw Star Head & DLP Plate Kit in MPB
- LS24STARDLPKITALLMPB** 2.4mm Locking Screw Star Head & DLP Plate Kit in MPB
- LS27STARDLPKITALLMPB** 2.7mm Locking Screw Star Head & DLP Plate Kit in MPB
- LS35STARDLPKITALLMPB** 3.5mm Locking Screw Star Head & DLP Plate Kit in MPB

### Combined Dynamic Locking Plate Kits



Our combined DLP kits contain the most popular size combinations of DLP plates and combined screw caddies, which includes both star drive locking and star drive cortical screws.

- DLP15KIT-MPB** DLP Plating Kit 1.5 Mix Star Lock & Cort Screw Caddies
- DLP1520-MPB** DLP Plating Kit 1.5/2.0 Mix Star Lock & Cort Screw Caddies
- DLP152024KIT-MPB** DLP Plating Kit 1.5/2.0/2.4 Mix Star Lock & Cort Screw Caddies
- DLP2024KIT-MPB** DLP Plating Kit 2.0/2.4 Mix Star Lock & Cort Screw Caddies
- DLP2735KIT-MPB** DLP Plating Kit 2.7/3.5 Mix Star Lock & Cort Screw Caddies

### Star Drive Cortical Self Tapping Kits



- CORTSTPKITSTAR152024MPB** 1.5/2.4mm Complete Self Tapping Star Drive Screw Cortical Kit
- CORTSTPKITSTAR27/35MPB** 2.7/3.5mm Complete Self Tapping Star Drive Screw Cortical Kit

### Hex Head Cortical Self Tapping Kits



Our MPB self tapping cortical kits contain plates, screws & required instrumentation.

- CORTSTPI52024MPB** 1.5/2.0/2.4mm Self Tapping Cortical Kit In MPB
- CORTSTP2735MPB** 2.7/3.5mm Self Tapping Cortical Kit In MPB
- CORTSTKIT4.5MPB** 4.5mm Self Tapping Cortical Kit In MPB

### Locking Screw Sets



Star drive locking screw sets in modular plating box screw caddy.

- LS15STARKITMPB** 1.5 Star Drive Locking Screw Set
- LS20STARKITMPB** 2.0 Star Drive Locking Screw Set
- LS24STARKITMPB** 2.4 Star Drive Locking Screw Set
- LS27STARKITMPB** 2.7 Star Drive Locking Screw Set
- LS35STARKITMPB** 3.5 Star Drive Locking Screw Set

### Combined Screw Sets

The screw caddies contain both star drive locking and star drive cortical screws.

- MPBSC15-MIX** 1.5mm Screw Caddy With Star Drive Locking & Cortical Screws
- MPBSC20-MIX** 2.0mm Screw Caddy With Star Drive Locking & Cortical Screws
- MPBSC24-MIX** 2.4mm Screw Caddy With Star Drive Locking & Cortical Screws
- MPBSC27-MIX** 2.7mm Screw Caddy With Star Drive Locking & Cortical Screws
- MPBSC35-MIX** 3.5mm Screw Caddy With Star Drive Locking & Cortical Screws

### Cortical Screw Sets

Star drive cortical screw sets in modular plating box screw caddy.

- MPBSC15-SDCS** 1.5mm Screw Caddy With Star Drive Cortical Screws
- MPBSC20-SDCS** 2.0mm Screw Caddy With Star Drive Cortical Screws
- MPBSC24-SDCS** 2.4mm Screw Caddy With Star Drive Cortical Screws
- MPBSC27-SDCS** 2.7mm Screw Caddy With Star Drive Cortical Screws
- MPBSC35-SDCS** 3.5mm Screw Caddy With Star Drive Cortical Screws

Hex drive cortical self tapping screw sets in modular plating box screw caddy.

- MPBSC15-CSST** 1.5mm Screw Caddy With Self Tap Cortical Screws
- MPBSC20-CSST** 2.0mm Screw Caddy With Self Tap Cortical Screws
- MPBSC24-CSST** 2.4mm Screw Caddy With Self Tap Cortical Screws
- MPBSC27-CSST** 2.7mm Screw Caddy With Self Tap Cortical Screws
- MPBSC35-CSST** 3.5mm Screw Caddy With Self Tap Cortical Screws

Full kit lists are available upon request.

### Modular Plating Box Components Modular Plating Box Base & Lid



**MPBB** Modular Plating Box Base  
**MPBL** Modular Plating Box Lid

### Modular Plating Box Instrument Trays



**MPBIT1520** 1.5/2.0mm MPB Instrument Tray  
**MPBIT24** 2.4mm MPB Instrument Tray  
**MPBIT2735I** 2.7/3.5mm MPB Instrument Tray I  
**MPBIT27352** 2.7/3.5mm MPB Instrument Tray 2  
**MPBIT45** 4.5mm MPB Combined Instrument & Plate Tray

### Modular Plating Box TPLO Instrument Trays

**MPBITTPLO1** Instrument Tray 1 For TPLO Kits  
**MPBITTPLO2** Instrument Tray 2 For TPLO Kits  
**MPBITTPLO3** Instrument Tray 3 For TPLO Kits

### Modular Plating Box Plate Trays For Locking Plates



**MPBPTL15** 1.5mm MPB Plate Tray For Locking Plates  
**MPBPTL2** 2.0mm MPB Plate Tray For Locking Plates  
**MPBPTL24** 2.4mm MPB Plate Tray For Locking Plates  
**MPBPTL2735** 2.7/3.5mm MPB Plate Tray For Locking Plates

### Modular Plating Box Plate Trays For Non-Locking Plates



**MPBPTNL15** 1.5mm MPB Plate Tray For Non-Locking Plates  
**MPBPTNL2** 2.0mm MPB Plate Tray For Non-Locking Plates  
**MPBPTNL24** 2.4mm MPB Plate Tray For Non-Locking Plates

### Modular Plating Box Screw Caddies



**MPBSC15** 1.5mm MPB Screw Caddy  
**MPBSC20** 2.0mm MPB Screw Caddy  
**MPBSC24** 2.4mm MPB Screw Caddy  
**MPBSC27** 2.7mm MPB Screw Caddy  
**MPBSC35** 3.5mm MPB Screw Caddy  
**MPBSC45** 4.5mm MPB Screw Caddy



## Dynamic Locking Plate Kits In Premium Box



Kit featured is LS24STARDLPKITALL

Our locking kits in anodised aluminium premium box contain plates, screws & required instrumentation.

- LS15STARDLPKITALL** 1.5mm Locking Screw Star Head & DLP Plate Kit in Prem Box
- LS20STARDLPKITALL** 2.0mm Locking Screw Star Head & DLP Plate Kit in Prem Box
- LS24STARDLPKITALL** 2.4mm Locking Screw Star Head & DLP Plate Kit in Prem Box
- LS27STARDLPKITALL** 2.7mm Locking Screw Star Head & DLP Plate Kit in Prem Box
- LS35STARDLPKITALL** 3.5mm Locking Screw Star Head & DLP Plate Kit in Prem Box

## Stacked Hole Locking Plate Kits In Premium Box

- LS20STARKITALL** 2.0mm Locking Screw Star Head & Plate Kit in Prem Box
- LS24STARKITALL** 2.4mm Locking Screw Star Head & Plate Kit in Prem Box
- LS27STARKITALL** 2.7mm Locking Screw Star Head & Plate Kit in Prem Box
- LS35STARKITALL** 3.5mm Locking Screw Star Head & Plate Kit in Prem Box
- LS35KITALL** 3.5mm Locking Screw Hex Head & Plate Kit in Prem Box

## Cortical Self Tapping Kits In Premium Boxes



Kit featured is CORTSTP2735

Our self tapping cortical kits in anodised aluminium premium box contain plates, screws & required instrumentation.

- CORTSTP152024** 1.5mm/2.0mm/2.4mm Cortical Self Tapping Kit in Premium Box
- CORTSTP2735** 2.7mm/3.5mm Cortical Self Tapping Kit in Premium Box

## 1.0mm Plating Kit



Management of fractures in dogs weighing less than a kilo is very challenging. Even 1.5 & 2.0mm screws are too large. Metacarpals in even some medium size patients require very small implants.

The range includes T-plates, compression plates & 5 different cuttable plates. Due to the small size, dedicated instrumentation is required.

- CORTSTP10** 1.0mm Plating Set in Premium Box

## Cortical Kits In Stainless Box



Kit featured is CORTSTKIT2735

Our cortical & cortical self tapping kits in stainless box contain plates, screws & required instrumentation.

- CORTKIT1.5/2** 1.5mm/2.0mm Cortical Kit In Stainless Box
- CORTKIT2.7/3.5** 2.7mm/3.5mm Cortical Kit In Stainless Box

## Cortical Self Tapping Kits In Stainless Box

- CORTSTKIT1.5** 1.5mm Cortical Self Tapping Kit In Stainless Box
- CORTSTKIT1.5/2** 1.5/2.0mm Cortical Self Tapping Kit In Stainless Box
- CORTSTKIT2.0** 2.0mm Cortical Self Tapping Kit In Stainless Box
- CORTSTKIT24** 2.4mm Cortical Self Tapping Kit In Stainless Box
- CORTSTKIT2735** 2.7/3.5mm Cortical Self Tapping Kit In Stainless Box

## Cortical Self Tapping Kits With Limited Contact (LC) Compression Plates

- LCORTSTKIT24** 2.4mm Cortical Self Tapping Kit With LC Compression Plates In Stainless Box
- LCORTSTKIT2735** 2.7mm/3.5mm Cortical Self Tapping Kit With LC Compression Plates In Stainless Box

## Locking Screw Sets



Available with either Hex (3.5mm only) or Star Drive Head.

- LS15STARKIT** 1.5 Star Drive Locking Screw Set
- LS20STARKIT** 2.0 Star Drive Locking Screw Set
- LS24STARKIT** 2.4 Star Drive Locking Screw Set
- LS27STARKIT** 2.7 Star Drive Locking Screw Set
- LS35STARKIT** 3.5 Star Drive Locking Screw Set
- LS35KIT** 3.5 Hex Drive Locking Screw Set

Full kit lists are available upon request.

### Vi Plate Selection Chart

This chart is for **guidance only** & precise implant selection depends on a number of factors which are to be considered when assessing the fracture healing score & the mechanical behaviour of implants; this should be taken into account when making a definitive selection.

Unless otherwise stated, values apply to Vi compression, limited contact compression, ASYM®, round hole & biological healing plates.

Scaled plate profiles are available in the catalogue or download the profiles from our website [www.vetinst.com](http://www.vetinst.com)

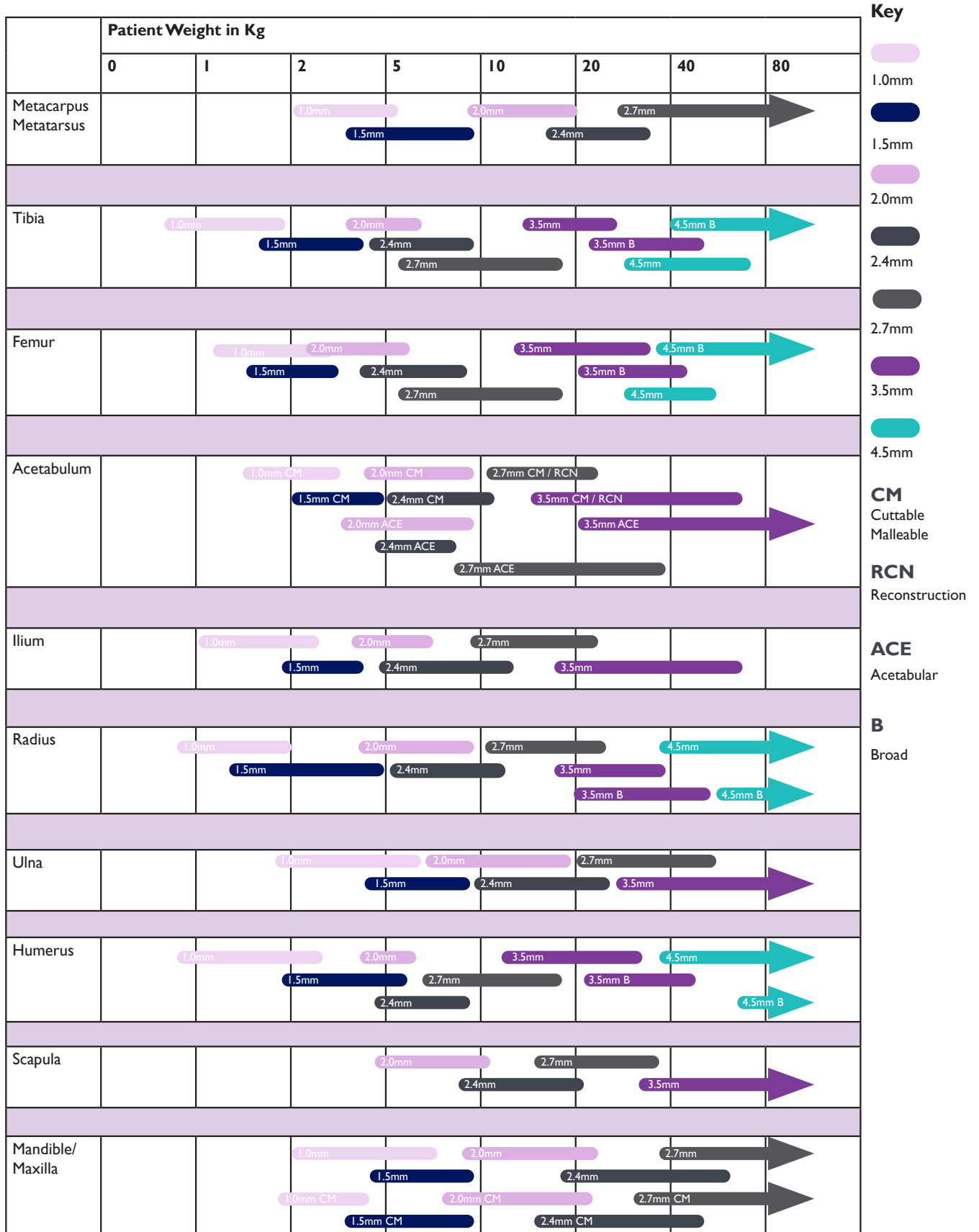

## 1.0mm Plates

1.0mm implants currently available consist of a range of straight plates, cuttable plates & an extensive range of T-Plates for radial fractures.

### 1.0mm Compression Plates



- CI00210** 1mm Dynamic Compression Plate 10mm 2 Hole
- CI00314** 1mm Dynamic Compression Plate 14mm 3 Hole
- CI00418** 1mm Dynamic Compression Plate 18mm 4 Hole
- CI00522** 1mm Dynamic Compression Plate 22mm 5 Hole
- CI00626** 1mm Dynamic Compression Plate 26mm 6 Hole
- CI00730** 1mm Dynamic Compression Plate 30mm 7 Hole
- CI00834** 1mm Dynamic Compression Plate 34mm 8 Hole
- CI00938** 1mm Dynamic Compression Plate 38mm 9 Hole
- CI01042** 1mm Dynamic Compression Plate 42mm 10 Hole

### 1.0mm Cuttable Plates



The Vi range of cuttable 1.0mm plates gives flexibility of management options for a number of different fracture scenarios. All of our 1.0mm Cuttable Plates have round holes.

Use the dedicated compound action implant cutters (001230) to cut plates.

- CP10390** Cuttable Plate 1.0mm 30 Holes 90mm Long
- CP10491** Cuttable Plate 1.0mm 23 Holes 91mm Long
- CM10390** Cuttable Malleable Plate 1.0mm 30 Holes 90mm Long

### 1.0mm Cuttable Plates With Spaces



1.0mm cuttable plate with spaces to give the surgeon additional options. Versions are available with either 3mm or 4mm hole spacing.

- CP1039027** Cuttable Plate 1.0mm 27 Holes 90 mm 3mm Spaces
- CP1049120** Cuttable Plate 1.0mm 20 Holes 91mm 4mm Spaces

### 1.0mm T-Plates



The 1.0mm T-Plates have been designed by Vi to provide options for the repair of distal radial fractures in very small dogs & in cats. These fractures can be difficult to manage, partly because of the small sizes of the bones involved & partly because the area has relatively poor vascularity resulting in what is often a prolonged healing time.

- T101016** 1mm T Plate 16mm 5 Hole
- T101018** 1mm T Plate 18mm 5 Hole
- T101020** 1mm T Plate 20mm 6 Hole
- T101021** 1mm T Plate 21mm 6 Hole
- T101022** 1mm T Plate 22mm 6 Hole
- T101024** 1mm T Plate 24mm 7 Hole
- T101026** 1mm T Plate 26mm 7 Hole
- T101027** 1mm T Plate 27mm 7 Hole

## 1.0mm Cortical Self Tapping Screws

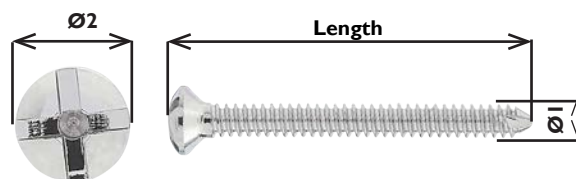

Use 0.7mm pilot drill & 1.0mm cruciate screwdriver. The threads on the screws are very fine. Caution must be exercised at the final tightening.

- CSST1004** 1mm Self Tapping Screw 4mm
- CSST1005** 1mm Self Tapping Screw 5mm
- CSST1006** 1mm Self Tapping Screw 6mm
- CSST1007** 1mm Self Tapping Screw 7mm
- CSST1008** 1mm Self Tapping Screw 8mm
- CSST1009** 1mm Self Tapping Screw 9mm
- CSST1010** 1mm Self Tapping Screw 10mm
- CSST1011** 1mm Self Tapping Screw 11mm
- CSST1012** 1mm Self Tapping Screw 12mm
- CSST1013** 1mm Self Tapping Screw 13mm
- CSST1014** 1mm Self Tapping Screw 14mm
- CSST1015** 1mm Self Tapping Screw 15mm

### Screwdriver Insert

- SDINI.0-A** Dental Fit Screw Driver Insert For 1mm Screws

### Drill Guide 0.7/1.0mm



Due to the size limitations, this device serves only as a drill guide & cannot be used as an insert sleeve or tap guide.

- CDTIS10** Drill Guide 0.7mm/1.0mm

### 1.0mm Plate Holding Forceps



Use to hold a plate in position on the bone.

- CIPHF** 1.0mm Plate Holding Forceps

### Mini Quick Release Drill Bits - Dental Fit

These smaller drill bits are too delicate for use with a power drill, & are designed for use with the D17-080 dental fit handle. This improves control & helps prevent breakages.

- 10MDB07-A** 0.7mm Drill Bit For D17-080 Quick Release Handle Dental Fit
- 10MDB10-A** 1.0mm Drill Bit For D17-080 Quick Release Handle Dental Fit

For scaled plate profiles, please view the Plate Profile chapter.

## Vi Dynamic Locking Plates

To view our Surgery Guide on 'Fixation of Long Bone (Diaphyseal) Fractures Using Locking Plates and Screws' please scan the QR code below.



- Combining compression & locking technology in one plate.
- 270° of locking thread engagement in plate for superior security.
- Compression section of hole allows up to 35° of screw angulation.
- Suitable for MIPO application - spade end for easier insertion, single full locking hole at opposite end allows drill guide to be used to aid plate manipulation.



### 1.5mm Vi Dynamic Locking Plates

<b>DLP1504024</b>	1.5mm Dynamic Locking Plate 4 Hole 24mm Long
<b>DLP1505030</b>	1.5mm Dynamic Locking Plate 5 Hole 30mm Long
<b>DLP1506036</b>	1.5mm Dynamic Locking Plate 6 Hole 36mm Long
<b>DLP1507042</b>	1.5mm Dynamic Locking Plate 7 Hole 42mm Long
<b>DLP1508048</b>	1.5mm Dynamic Locking Plate 8 Hole 48mm Long
<b>DLP1509054</b>	1.5mm Dynamic Locking Plate 9 Hole 54mm Long
<b>DLP1510060</b>	1.5mm Dynamic Locking Plate 10 Hole 60mm Long
<b>DLP1511066</b>	1.5mm Dynamic Locking Plate 11 Hole 66mm Long
<b>DLP1512072</b>	1.5mm Dynamic Locking Plate 12 Hole 72mm Long

### 2.0mm Vi Dynamic Locking Plates

1.5mm thick

<b>DLP2004031</b>	Dynamic Locking Plate 2.0mm 4 Hole 31mm Long
<b>DLP2005038</b>	Dynamic Locking Plate 2.0mm 5 Hole 38mm Long
<b>DLP2006045</b>	Dynamic Locking Plate 2.0mm 6 Hole 45mm Long
<b>DLP2007052</b>	Dynamic Locking Plate 2.0mm 7 Hole 52mm Long
<b>DLP2008059</b>	Dynamic Locking Plate 2.0mm 8 Hole 59mm Long
<b>DLP2009066</b>	Dynamic Locking Plate 2.0mm 9 Hole 66mm Long
<b>DLP2010073</b>	Dynamic Locking Plate 2.0mm 10 Hole 73mm Long
<b>DLP2011080</b>	Dynamic Locking Plate 2.0mm 11 Hole 80mm Long
<b>DLP2012087</b>	Dynamic Locking Plate 2.0mm 12 Hole 87mm Long
<b>DLP2013094</b>	Dynamic Locking Plate 2.0mm 13 Hole 94mm Long
<b>DLP2014101</b>	Dynamic Locking Plate 2.0mm 14 Hole 101mm Long

### 2.4mm Vi Dynamic Locking Plates

Available in two thicknesses - 1.7mm (thin) & 2.0mm (thick).

<b>DLP2404038N</b>	Dynamic Locking Plate 2.4mm Thin 4 Holes 38mm Long
<b>DLP2405047N</b>	Dynamic Locking Plate 2.4mm Thin 5 Holes 47mm Long
<b>DLP2405047K</b>	Dynamic Locking Plate 2.4mm Thick 5 Holes 47mm Long
<b>DLP2406056N</b>	Dynamic Locking Plate 2.4mm Thin 6 Holes 56mm Long
<b>DLP2406056K</b>	Dynamic Locking Plate 2.4mm Thick 6 Holes 56mm Long
<b>DLP2407065N</b>	Dynamic Locking Plate 2.4mm Thin 7 Holes 65mm Long
<b>DLP2407065K</b>	Dynamic Locking Plate 2.4mm Thick 7 Holes 65mm Long
<b>DLP2408074N</b>	Dynamic Locking Plate 2.4mm Thin 8 Holes 74mm Long
<b>DLP2408074K</b>	Dynamic Locking Plate 2.4mm Thick 8 Holes 74mm Long
<b>DLP2409083N</b>	Dynamic Locking Plate 2.4mm Thin 9 Holes 83mm Long
<b>DLP2409083K</b>	Dynamic Locking Plate 2.4mm Thick 9 Holes 83mm Long
<b>DLP2410092N</b>	Dynamic Locking Plate 2.4mm Thin 10 Holes 92mm Long
<b>DLP2410092K</b>	Dynamic Locking Plate 2.4mm Thick 10 Holes 92mm Long

<b>DLP2411101N</b>	Dynamic Locking Plate 2.4mm Thin 11 Holes 101mm Long
<b>DLP2411101K</b>	Dynamic Locking Plate 2.4mm Thick 11 Holes 101mm Long
<b>DLP2412110K</b>	Dynamic Locking Plate 2.4mm Thick 12 Holes 110mm Long
<b>DLP2413119N</b>	Dynamic Locking Plate 2.4mm Thin 13 Holes 119mm Long
<b>DLP2413119K</b>	Dynamic Locking Plate 2.4mm Thick 13 Holes 119mm Long
<b>DLP2414128K</b>	Dynamic Locking Plate 2.4mm Thick 14 Holes 128mm Long
<b>DLP2415137K</b>	Dynamic Locking Plate 2.4mm Thick 15 Holes 137mm Long
<b>DLP2416146K</b>	Dynamic Locking Plate 2.4mm Thick 16 Holes 146mm Long
<b>DLP2417155K</b>	Dynamic Locking Plate 2.4mm Thick 17 Holes 155mm Long
<b>DLP2418164K</b>	Dynamic Locking Plate 2.4mm Thick 18 Holes 164mm Long

### 2.7mm Vi Dynamic Locking Plates

<b>DLP2704038</b>	Dynamic Locking Plate 2.7mm 4 Holes 38mm Long
<b>DLP2705047</b>	Dynamic Locking Plate 2.7mm 5 Holes 47mm Long
<b>DLP2706056</b>	Dynamic Locking Plate 2.7mm 6 Holes 56mm Long
<b>DLP2707065</b>	Dynamic Locking Plate 2.7mm 7 Holes 65mm Long
<b>DLP2708074</b>	Dynamic Locking Plate 2.7mm 8 Holes 74mm Long
<b>DLP2709083</b>	Dynamic Locking Plate 2.7mm 9 Holes 83mm Long
<b>DLP2710092</b>	Dynamic Locking Plate 2.7mm 10 Holes 92mm Long
<b>DLP2711101</b>	Dynamic Locking Plate 2.7mm 11 Holes 101mm Long
<b>DLP2712110</b>	Dynamic Locking Plate 2.7mm 12 Holes 110mm Long
<b>DLP2713119</b>	Dynamic Locking Plate 2.7mm 13 Holes 119mm Long
<b>DLP2714128</b>	Dynamic Locking Plate 2.7mm 14 Holes 128mm Long
<b>DLP2715137</b>	Dynamic Locking Plate 2.7mm 15 Holes 137mm Long
<b>DLP2716146</b>	Dynamic Locking Plate 2.7mm 16 Holes 146mm Long
<b>DLP2717155</b>	Dynamic Locking Plate 2.7mm 17 Holes 155mm Long
<b>DLP2718164</b>	Dynamic Locking Plate 2.7mm 18 Holes 164mm Long

### 3.5mm Vi Dynamic Locking Plates

<b>DLP3504055</b>	Dynamic Locking Plate 3.5mm 4 Holes 55mm Long
<b>DLP3505068</b>	Dynamic Locking Plate 3.5mm 5 Holes 68mm Long
<b>DLP3506081</b>	Dynamic Locking Plate 3.5mm 6 Holes 81mm Long
<b>DLP3507094</b>	Dynamic Locking Plate 3.5mm 7 Holes 94mm Long
<b>DLP3508107</b>	Dynamic Locking Plate 3.5mm 8 Holes 107mm Long
<b>DLP3509120</b>	Dynamic Locking Plate 3.5mm 9 Holes 120mm Long
<b>DLP3510133</b>	Dynamic Locking Plate 3.5mm 10 Holes 133mm Long
<b>DLP3511146</b>	Dynamic Locking Plate 3.5mm 11 Holes 146mm Long
<b>DLP3512159</b>	Dynamic Locking Plate 3.5mm 12 Holes 159mm Long
<b>DLP3513172</b>	Dynamic Locking Plate 3.5mm 13 Holes 172mm Long
<b>DLP3514185</b>	Dynamic Locking Plate 3.5mm 14 Holes 185mm Long
<b>DLP3515198</b>	Dynamic Locking Plate 3.5mm 15 Holes 198mm Long
<b>DLP3516211</b>	Dynamic Locking Plate 3.5mm 16 Holes 211mm Long
<b>DLP3517224</b>	Dynamic Locking Plate 3.5mm 17 Holes 224mm Long
<b>DLP3518237</b>	Dynamic Locking Plate 3.5mm 18 Holes 237mm Long

### 3.5mm Vi Dynamic Locking Plates Broad

<b>DLP35B07095</b>	3.5mm Broad Dynamic Locking Plate 7 Holes 95mm Long
<b>DLP35B08108</b>	3.5mm Broad Dynamic Locking Plate 8 Holes 108mm Long
<b>DLP35B09121</b>	3.5mm Broad Dynamic Locking Plate 9 Holes 121mm Long
<b>DLP35B10134</b>	3.5mm Broad Dynamic Locking Plate 10 Holes 134mm Long
<b>DLP35B11147</b>	3.5mm Broad Dynamic Locking Plate 11 Holes 147mm Long
<b>DLP35B12160</b>	3.5mm Broad Dynamic Locking Plate 12 Holes 160mm Long
<b>DLP35B13173</b>	3.5mm Broad Dynamic Locking Plate 13 Holes 173mm Long
<b>DLP35B14186</b>	3.5mm Broad Dynamic Locking Plate 14 Holes 186mm Long
<b>DLP35B15199</b>	3.5mm Broad Dynamic Locking Plate 15 Holes 199mm Long
<b>DLP35B16212</b>	3.5mm Broad Dynamic Locking Plate 16 Holes 212mm Long
<b>DLP35B18238</b>	3.5mm Broad Dynamic Locking Plate 18 Holes 238mm Long
<b>DLP35B20264</b>	3.5mm Broad Dynamic Locking Plate 20 Holes 264mm Long

For scaled plate profiles, please view the Plate Profile chapter.

## Stacked Hole Locking Plates

Stacked Hole Locking Plates are designed with round threaded plate holes which will accept either locking screws (at a fixed 90 degree angle), or cortical screws (some angulation is possible when using cortical screws). If a combination of dynamic compression & locking function is required, please refer to our range of Dynamic Locking Plates.



### 2.0mm Plates With Stacked Locking Holes

<b>LPSH200425</b>	2.0mm Locking Plate 4 Hole 25mm Long
<b>LPSH200531</b>	2.0mm Locking Plate 5 Hole 32mm Long
<b>LPSH200637</b>	2.0mm Locking Plate 6 Hole 37mm Long
<b>LPSH200743</b>	2.0mm Locking Plate 7 Hole 43mm Long
<b>LPSH200849</b>	2.0mm Locking Plate 8 Hole 49mm Long
<b>LPSH200955</b>	2.0mm Locking Plate 9 Hole 55mm Long
<b>LPSH201061</b>	2.0mm Locking Plate 10 Hole 61mm Long
<b>LPSH201167</b>	2.0mm Locking Plate 11 Hole 67mm Long
<b>LPSH201273</b>	2.0mm Locking Plate 12 Hole 73mm Long
<b>LPSH201379</b>	2.0mm Locking Plate 13 Hole 79mm Long
<b>LPSH201485</b>	2.0mm Locking Plate 14 Hole 85mm Long
<b>LS20PSET</b>	2.0mm Locking Plate Set (Contains One Of Each)

### 2.4mm Plates With Stacked Locking Holes

<b>LPSH240431</b>	2.4mm Locking Plate 4 Hole 31mm Long
<b>LPSH240538</b>	2.4mm Locking Plate 5 Hole 38mm Long
<b>LPSH240645</b>	2.4mm Locking Plate 6 Hole 45mm Long
<b>LPSH240752</b>	2.4mm Locking Plate 7 Hole 52mm Long
<b>LPSH240859</b>	2.4mm Locking Plate 8 Hole 59mm Long
<b>LPSH240966</b>	2.4mm Locking Plate 9 Hole 66mm Long
<b>LPSH241073</b>	2.4mm Locking Plate 10 Hole 73mm Long
<b>LPSH241180</b>	2.4mm Locking Plate 11 Hole 80mm Long
<b>LPSH241287</b>	2.4mm Locking Plate 12 Hole 87mm Long
<b>LPSH241394</b>	2.4mm Locking Plate 13 Hole 94mm Long
<b>LPSH2414101</b>	2.4mm Locking Plate 14 Hole 101mm Long
<b>LPSH2415108</b>	2.4mm Locking Plate 15 Hole 108mm Long
<b>LPSH2416115</b>	2.4mm Locking Plate 16 Hole 115mm Long
<b>LPSH2417122</b>	2.4mm Locking Plate 17 Hole 122mm Long
<b>LPSH2418129</b>	2.4mm Locking Plate 18 Hole 129mm Long
<b>LS24PSET</b>	2.4mm Locking Plate Set (Contains One Of Each)

### 2.7mm Plates With Stacked Locking Holes

<b>LPSH2704034</b>	2.7mm Locking Plate 4 Hole 34mm Long
<b>LPSH2705042</b>	2.7mm Locking Plate 5 Hole 42mm Long
<b>LPSH2706050</b>	2.7mm Locking Plate 6 Hole 50mm Long
<b>LPSH2707058</b>	2.7mm Locking Plate 7 Hole 58mm Long
<b>LPSH2708066</b>	2.7mm Locking Plate 8 Hole 66mm Long
<b>LPSH2709074</b>	2.7mm Locking Plate 9 Hole 74mm Long
<b>LPSH2710082</b>	2.7mm Locking Plate 10 Hole 82mm Long
<b>LPSH2711090</b>	2.7mm Locking Plate 11 Hole 90mm Long
<b>LPSH2712098</b>	2.7mm Locking Plate 12 Hole 98mm Long
<b>LPSH2713106</b>	2.7mm Locking Plate 13 Hole 106mm Long
<b>LPSH2714114</b>	2.7mm Locking Plate 14 Hole 114mm Long
<b>LPSH2715122</b>	2.7mm Locking Plate 15 Hole 122mm Long
<b>LPSH2716130</b>	2.7mm Locking Plate 16 Hole 130mm Long
<b>LPSH2717138</b>	2.7mm Locking Plate 17 Hole 138mm Long
<b>LPSH2718146</b>	2.7mm Locking Plate 18 Hole 146mm Long
<b>LS27PSET</b>	2.7mm Locking Plate Set (Contains One Of Each)

### 3.5mm Plates With Stacked Locking Holes

<b>LPSH3504046</b>	3.5mm Locking Plate 4 Hole 46mm
<b>LPSH3505056</b>	3.5mm Locking Plate 5 Hole 56mm
<b>LPSH3506066</b>	3.5mm Locking Plate 6 Hole 66mm
<b>LPSH3507076</b>	3.5mm Locking Plate 7 Hole 76mm
<b>LPSH3508086</b>	3.5mm Locking Plate 8 Hole 86mm
<b>LPSH3508126</b>	3.5mm Locking Plate 8 Hole 126mm
<b>LPSH3509096</b>	3.5mm Locking Plate 9 Hole 96mm
<b>LPSH3510106</b>	3.5mm Locking Plate 10 Hole 106mm
<b>LPSH3511116</b>	3.5mm Locking Plate 11 Hole 116mm
<b>LPSH3512126</b>	3.5mm Locking Plate 12 Hole 126mm
<b>LPSH3513136</b>	3.5mm Locking Plate 13 Hole 136mm
<b>LPSH3514146</b>	3.5mm Locking Plate 14 Hole 146mm
<b>LPSH3515156</b>	3.5mm Locking Plate 15 Hole 156mm
<b>LPSH3516166</b>	3.5mm Locking Plate 16 Hole 166mm
<b>LPSH3517176</b>	3.5mm Locking Plate 17 Hole 176mm
<b>LPSH3518186</b>	3.5mm Locking Plate 18 Hole 186mm
<b>LS35PSET</b>	3.5mm Locking Plate Set (Contains one of each)

For scaled plate profiles, please view the Plate Profile chapter.

## Cuttable Malleable Locking Plates

Vi Cuttable Malleable Locking Plates come into their own when pronounced contouring is necessary. They are well suited to situations where bone thickness or bone quality makes application of more conventional implants challenging, such as complicated pelvic fractures, as well as situations where mono-cortical application is desirable. With locking implants intimate bone contact is desirable, however, this is not essential.

The low profile makes these implants useful for craniomaxillofacial surgery & for other areas with limited soft tissue coverage. Manufactured from stainless steel grade 316LVM, they are stiffer than titanium implants of similar dimensions, but are still cuttable with standard implant cutters offering good versatility.

Use should be reserved for low load applications or when load sharing is possible between these & other implants such as with double plating techniques or when load sharing is possible with the bone. Use to span large defects is not recommended.

Contouring can be achieved with the appropriate sized bending levers or roller-style bending pliers. Cutting of these plates can be performed using an appropriately rated Implant Cutter.



Please note, Cuttable Malleable Plates & Cuttable Malleable Locking Plates are not suitable for weight bearing fractures unless used in conjunction with other plates.

<b>CM15LOCK</b>	1.5mm Cuttable Malleable Locking Plate 15 Holes 74mm Long
<b>CM20LOCK</b>	2.0mm Cuttable Malleable Locking Plate 15 Holes 103mm Long
<b>CM24LOCK</b>	2.4mm Cuttable Malleable Locking Plate 15 Holes 125mm Long
<b>CM27LOCK</b>	2.7mm Cuttable Malleable Locking Plate 15 Holes 148mm Long
<b>CM35LOCK</b>	3.5mm Cuttable Malleable Locking Plate 15 Holes 205mm Long

For scaled plate profiles, please view the Plate Profile chapter.

## LokRod™ Plates

The LokRod™ Plate was conceived & designed by David Strong MRCVS. LokRod™ Plates may prove useful as an alternative for more traditional fixation modalities, particularly in the management of feline comminuted long bone fractures with only small proximal & distal fragments.

LokRod™ Plates must be used with locking screws. It is mechanically stronger to place the implant as close to the functional axis of the bone as possible, so it is advised to have the underside of the plate holes snugged up to the bone as close as possible. Spanning of the whole bone reduces adverse screw loading & will improve implant life as well as reduce the chances of bone splitting at these sites.

The chamfered tip enables easier MIPO insertion & the small hole will engage a wire or the tips of reduction forceps to aid positioning. The cylindrical shaft minimises impact on surrounding soft tissues & helps reduce peak loading on the screw-plate & screw-bone interfaces.



<b>LRP24270470</b>	LokRod™ Plate 4 Hole 70mm Long
<b>LRP24270480</b>	LokRod™ Plate 4 Hole 80mm Long
<b>LRP24270490</b>	LokRod™ Plate 4 Hole 90mm Long
<b>LRP242704100</b>	LokRod™ Plate 4 Hole 100mm Long
<b>LRP242704110</b>	LokRod™ Plate 4 Hole 110mm Long

For scaled plate profiles, please view the Plate Profile chapter.

## Dynamic Compression Plates

To view our Surgery Guide on 'Fixation of Long Bone (Diaphyseal) Fractures Using Non-Locking Plates and Screws' please scan the QR code below.



Still a mainstay of veterinary orthopaedics, the DCP allows axial compression across the fracture line where desirable & appropriate. The use of the corresponding screw size, & correct sized Load Neutral Drill Guide for pilot hole placement, is essential to achieve axial compression.



### 1.5mm Dynamic Compression Plates

<b>CI50420</b>	1.5mm Dynamic Compression Plate 20mm 4 Hole
<b>CI50525</b>	1.5mm Dynamic Compression Plate 24.5mm 5 Hole
<b>CI50629</b>	1.5mm Dynamic Compression Plate 29mm 6 Hole
<b>CI50734</b>	1.5mm Dynamic Compression Plate 33.5mm 7 Hole
<b>CI50838</b>	1.5mm Dynamic Compression Plate 38mm 8 Hole
<b>CI50943</b>	1.5mm Dynamic Compression Plate 42.5mm 9 Hole
<b>CI51047</b>	1.5mm Dynamic Compression Plate 47mm 10 Hole
<b>CI51152</b>	1.5mm Dynamic Compression Plate 51.5mm 11 Hole
<b>CI51256</b>	1.5mm Dynamic Compression Plate 56mm 12 Hole
<b>CI51465</b>	1.5mm Dynamic Compression Plate 65mm 14 Hole
<b>CI51674</b>	1.5mm Dynamic Compression Plate 74mm 16 Hole

### 2.0mm Dynamic Compression Plates

<b>CP20422</b>	2mm Dynamic Compression Plate 22mm 4 Hole
<b>CP20527</b>	2mm Dynamic Compression Plate 27mm 5 Hole
<b>CP20632</b>	2mm Dynamic Compression Plate 32mm 6 Hole
<b>CP20737</b>	2mm Dynamic Compression Plate 37mm 7 Hole
<b>CP20842</b>	2mm Dynamic Compression Plate 42mm 8 Hole
<b>CP201052</b>	2mm Dynamic Compression Plate 52mm 10 Hole
<b>CP201262</b>	2mm Dynamic Compression Plate 62mm 12 Hole
<b>CP201472</b>	2mm Dynamic Compression Plate 72mm 14 Hole
<b>CP201682</b>	2mm Dynamic Compression Plate 82mm 16 Hole
<b>CP201892</b>	2mm Dynamic Compression Plate 92mm 18 Hole
<b>MP20317</b>	2mm Mini DCP Plate 17mm 3 Hole
<b>MP20423</b>	2mm Mini DCP Plate 23mm 4 Hole
<b>MP20529</b>	2mm Mini DCP Plate 29mm 5 Hole
<b>MP20635</b>	2mm Mini DCP Plate 35mm 6 Hole
<b>MP20741</b>	2mm Mini DCP Plate 41mm 7 Hole

### 2.4mm Dynamic Compression Plates

<b>C240431</b>	2.4mm Dynamic Compression Plate 31mm 4 Hole
<b>C240538</b>	2.4mm Dynamic Compression Plate 38mm 5 Hole
<b>C240645</b>	2.4mm Dynamic Compression Plate 45mm 6 Hole
<b>C240752</b>	2.4mm Dynamic Compression Plate 52mm 7 Hole
<b>C240859</b>	2.4mm Dynamic Compression Plate 59mm 8 Hole
<b>C240966</b>	2.4mm Dynamic Compression Plate 66mm 9 Hole
<b>C241073</b>	2.4mm Dynamic Compression Plate 73mm 10 Hole
<b>C241180</b>	2.4mm Dynamic Compression Plate 80mm 11 Hole
<b>C241287</b>	2.4mm Dynamic Compression Plate 87mm 12 Hole
<b>C241401</b>	2.4mm Dynamic Compression Plate 101mm 14 Hole
<b>C241615</b>	2.4mm Dynamic Compression Plate 115mm 16 Hole

### 2.7mm Dynamic Compression Plates

<b>C2702020</b>	2.7mm Dynamic Compression Plate 21mm 2 Hole
<b>C2704036</b>	2.7mm Dynamic Compression Plate 37mm 4 Hole
<b>C2705044</b>	2.7mm Dynamic Compression Plate 45mm 5 Hole
<b>C2706052</b>	2.7mm Dynamic Compression Plate 53mm 6 Hole
<b>C2707060</b>	2.7mm Dynamic Compression Plate 61mm 7 Hole
<b>C2708068</b>	2.7mm Dynamic Compression Plate 69mm 8 Hole
<b>C2709076</b>	2.7mm Dynamic Compression Plate 77mm 9 Hole
<b>C2710084</b>	2.7mm Dynamic Compression Plate 85mm 10 Hole
<b>C2712100</b>	2.7mm Dynamic Compression Plate 100mm 12 Hole
<b>C2714116</b>	2.7mm Dynamic Compression Plate 116mm 14 Hole
<b>C2716132</b>	2.7mm Dynamic Compression Plate 133mm 16 Hole
<b>C2718148</b>	2.7mm Dynamic Compression Plate 148mm 18 Hole

### 3.5mm Dynamic Compression Plates

<b>C3503038</b>	3.5mm Dynamic Compression Plate 37mm 3 Hole
<b>C3504050</b>	3.5mm Dynamic Compression Plate 50mm 4 Hole
<b>C3505062</b>	3.5mm Dynamic Compression Plate 62mm 5 Hole
<b>C3506074</b>	3.5mm Dynamic Compression Plate 74mm 6 Hole
<b>C3507086</b>	3.5mm Dynamic Compression Plate 86mm 7 Hole
<b>C3508098</b>	3.5mm Dynamic Compression Plate 98mm 8 Hole
<b>C3509111</b>	3.5mm Dynamic Compression Plate 111mm 9 Hole
<b>C3510122</b>	3.5mm Dynamic Compression Plate 122mm 10 Hole
<b>C3512146</b>	3.5mm Dynamic Compression Plate 146mm 12 Hole
<b>C3514170</b>	3.5mm Dynamic Compression Plate 170mm 14 Hole
<b>C3516194</b>	3.5mm Dynamic Compression Plate 194mm 16 Hole
<b>C3518218</b>	3.5mm Dynamic Compression Plate 218mm 18 Hole
<b>C3520242</b>	3.5mm Dynamic Compression Plate 242mm 20 Hole

### Broad 3.5mm Dynamic Compression Plates

<b>BC3504050</b>	3.5mm Broad Dynamic Compression Plate 50mm 4 Hole
<b>BC3505062</b>	3.5mm Broad Dynamic Compression Plate 62mm 5 Hole
<b>BC3506074</b>	3.5mm Broad Dynamic Compression Plate 74mm 6 Hole
<b>BC3507087</b>	3.5mm Broad Dynamic Compression Plate 87mm 7 Hole
<b>BC3508098</b>	3.5mm Broad Dynamic Compression Plate 98mm 8 Hole
<b>BC3509110</b>	3.5mm Broad Dynamic Compression Plate 110mm 9 Hole
<b>BC3510122</b>	3.5mm Broad Dynamic Compression Plate 122mm 10 Hole
<b>BC3511134</b>	3.5mm Broad Dynamic Compression Plate 134mm 11 Hole
<b>BC3512146</b>	3.5mm Broad Dynamic Compression Plate 146mm 12 Hole
<b>BC3513158</b>	3.5mm Broad Dynamic Compression Plate 158mm 13 Hole
<b>BC3514170</b>	3.5mm Broad Dynamic Compression Plate 170mm 14 Hole
<b>BC3515182</b>	3.5mm Broad Dynamic Compression Plate 182mm 15 Hole
<b>BC3516194</b>	3.5mm Broad Dynamic Compression Plate 194mm 16 Hole
<b>BC3518218</b>	3.5mm Broad Dynamic Compression Plate 218mm 18 Hole

### Narrow 4.5mm Dynamic Compression Plates

- C45355** 4.5mm Dynamic Compression Plate Narrow 55mm 3 Hole
- C45471** 4.5mm Dynamic Compression Plate Narrow 71mm 4 Hole
- C45587** 4.5mm Dynamic Compression Plate Narrow 87mm 5 Hole
- C456103** 4.5mm Dynamic Compression Plate Narrow 103mm 6 Hole
- C457119** 4.5mm Dynamic Compression Plate Narrow 119mm 7 Hole
- C458135** 4.5mm Dynamic Compression Plate Narrow 135mm 8 Hole
- C459151** 4.5mm Dynamic Compression Plate Narrow 151mm 9 Hole
- C4510167** 4.5mm Dynamic Compression Plate Narrow 167mm 10 Hole
- C4511183** 4.5mm Dynamic Compression Plate Narrow 183mm 11 Hole
- C4512199** 4.5mm Dynamic Compression Plate Narrow 199mm 12 Hole
- C4513215** 4.5mm Dynamic Compression Plate Narrow 215mm 13 Hole
- C4514231** 4.5mm Dynamic Compression Plate Narrow 231mm 14 Hole
- C4515246** 4.5mm Dynamic Compression Plate Narrow 246mm 15 Hole
- C4518296** 4.5mm Dynamic Compression Plate Narrow 296mm 18 Hole

### Broad 4.5mm Dynamic Compression Plates

- B450587** 4.5mm Broad Dynamic Compression Plate 87mm 5 Hole
- B4507119** 4.5mm Broad Dynamic Compression Plate 119mm 7 Hole
- B4508135** 4.5mm Broad Dynamic Compression Plate 135mm 8 Hole
- B4509151** 4.5mm Broad Dynamic Compression Plate 151mm 9 Hole
- B4510167** 4.5mm Broad Dynamic Compression Plate 167mm 10 Hole
- B4511183** 4.5mm Broad Dynamic Compression Plate 183mm 11 Hole
- B4512199** 4.5mm Broad Dynamic Compression Plate 199mm 12 Hole
- B4513215** 4.5mm Broad Dynamic Compression Plate 215mm 13 Hole
- B4515247** 4.5mm Broad Dynamic Compression Plate 247mm 15 Hole
- B4516263** 4.5mm Broad Dynamic Compression Plate 263mm 16 Hole
- B4517279** 4.5mm Broad Dynamic Compression Plate 279mm 17 Hole
- B4518295** 4.5mm Broad Dynamic Compression Plate 295mm 18 Hole

For scaled plate profiles, please view the Plate Profile chapter.



### Email Marketing Service

Our marketing emails are designed to **educate**, to keep you up to date with what's new at Vi & share **exclusive offers & discounts**.

Sign up today by scanning the QR code below.





## Limited Contact Compression Plates

Very similar in design to the DCP, the Limited Contact Compression Plate allows axial compression across the fracture line where desirable & appropriate. The undercuts on the bone-facing surface are designed to reduce plate-bone contact, in theory resulting in a reduction in periosteal damage & facilitating more rapid bone healing. The use of the corresponding screw size, & correct sized Load Neutral Drill Guide for pilot hole placement, is essential to achieve axial compression.



## 2.4mm Limited Contact Compression Plates

LC2404038	2.4mm Limited Contact Compression Plate 38mm 4 Hole
LC2405046	2.4mm Limited Contact Compression Plate 46mm 5 Hole
LC2406054	2.4mm Limited Contact Compression Plate 54mm 6 Hole
LC2407062	2.4mm Limited Contact Compression Plate 62mm 7 Hole
LC2408070	2.4mm Limited Contact Compression Plate 70mm 8 Hole
LC2409078	2.4mm Limited Contact Compression Plate 78mm 9 Hole
LC2410086	2.4mm Limited Contact Compression Plate 86mm 10 Hole
LC2411094	2.4mm Limited Contact Compression Plate 94mm 11 Hole
LC2412102	2.4mm Limited Contact Compression Plate 102mm 12 Hole

## 2.7mm Limited Contact Compression Plates

LC2704044	2.7mm Limited Contact Compression Plate 44mm 4 Hole
LC2705053	2.7mm Limited Contact Compression Plate 53mm 5 Hole
LC2706062	2.7mm Limited Contact Compression Plate 62mm 6 Hole
LC2707071	2.7mm Limited Contact Compression Plate 71mm 7 Hole
LC2708080	2.7mm Limited Contact Compression Plate 80mm 8 Hole
LC2709089	2.7mm Limited Contact Compression Plate 89mm 9 Hole
LC2710098	2.7mm Limited Contact Compression Plate 98mm 10 Hole
LC2712116	2.7mm Limited Contact Compression Plate 116mm 12 Hole
LC2714134	2.7mm Limited Contact Compression Plate 134mm 14 Hole

## 3.5mm Limited Contact Compression Plates

LC3504056	3.5mm Limited Contact Compression Plate 56mm 4 Hole
LC3505069	3.5mm Limited Contact Compression Plate 69mm 5 Hole
LC3506082	3.5mm Limited Contact Compression Plate 82mm 6 Hole
LC3507095	3.5mm Limited Contact Compression Plate 95mm 7 Hole
LC3508108	3.5mm Limited Contact Compression Plate 108mm 8 Hole
LC3509121	3.5mm Limited Contact Compression Plate 121mm 9 Hole
LC3510134	3.5mm Limited Contact Compression Plate 134mm 10 Hole
LC3512160	3.5mm Limited Contact Compression Plate 160mm 12 Hole
LC3516212	3.5mm Limited Contact Compression Plate 212mm 16 Hole

## Broad 3.5mm Limited Contact Compression Plates

BLC3507095	3.5mm Broad Limited Contact Compression Plate 95mm 7 Hole
BLC3508108	3.5mm Broad Limited Contact Compression Plate 108mm 8 Hole
BLC3509121	3.5mm Broad Limited Contact Compression Plate 121mm 9 Hole
BLC3512160	3.5mm Broad Limited Contact Compression Plate 160mm 12 Hole

For scaled plate profiles, please view the Plate Profile chapter.

## ASYM<sup>®</sup> Plates

Plate design combining the established principles of round hole & compression plates. These plates are particularly suitable for a fracture or osteotomy scenario where one fragment is significantly smaller, (more distal/proximal) than the other. The round holes provide greater screw stability, & allow for more screws to be placed, in the smaller fragment, whilst compression can still be applied from the longer segment.



### 2.0mm ASYM<sup>®</sup> Plates

<b>ASYM20030437</b>	2mm ASYM Plate 37mm 4 Compression 3 Round Holes
<b>ASYM20030542</b>	2mm ASYM Plate 42mm 5 Compression 3 Round Holes
<b>ASYM20030647</b>	2mm ASYM Plate 47mm 6 Compression 3 Round Holes
<b>ASYM20030752</b>	2mm ASYM Plate 52mm 7 Compression 3 Round Holes
<b>ASYM20040652</b>	2mm ASYM Plate 52mm 6 Compression 4 Round Holes
<b>ASYM20030857</b>	2mm ASYM Plate 57mm 8 Compression 3 Round Holes
<b>ASYM20040757</b>	2mm ASYM Plate 57mm 7 Compression 4 Round Holes
<b>ASYM20040862</b>	2mm ASYM Plate 62mm 8 Compression 4 Round Holes
<b>ASYM20031067</b>	2mm ASYM Plate 67mm 10 Compression 3 Round Holes
<b>ASYM20031172</b>	2mm ASYM Plate 72mm 11 Compression 3 Round Holes
<b>ASYM20041072</b>	2mm ASYM Plate 72mm 10 Compression 4 Round Holes

### 2.4mm ASYM<sup>®</sup> Plates

<b>ASYM240304052</b>	2.4mm ASYM Plates 52mm 4 Compression 3 Round Holes
<b>ASYM240305059</b>	2.4mm ASYM Plates 59mm 5 Compression 3 Round Holes
<b>ASYM240306066</b>	2.4mm ASYM Plates 66mm 6 Compression 3 Round Holes
<b>ASYM240307073</b>	2.4mm ASYM Plates 73mm 7 Compression 3 Round Holes
<b>ASYM240406073</b>	2.4mm ASYM Plates 73mm 6 Compression 4 Round Holes
<b>ASYM240407080</b>	2.4mm ASYM Plates 80mm 7 Compression 4 Round Holes
<b>ASYM240408087</b>	2.4mm ASYM Plates 87mm 8 Compression 4 Round Holes
<b>ASYM240310094</b>	2.4mm ASYM Plates 94mm 10 Compression 3 Round Holes
<b>ASYM240409094</b>	2.4mm ASYM Plates 94mm 9 Compression 4 Round Holes
<b>ASYM240311101</b>	2.4mm ASYM Plates 101mm 11 Compression 3 Round Holes
<b>ASYM240410101</b>	2.4mm ASYM Plates 101mm 10 Compression 4 Round Holes

### 2.7mm ASYM<sup>®</sup> Plates

<b>ASYM270304060</b>	2.7mm ASYM Plate 60mm 4 Compression 3 Round Holes
<b>ASYM270305068</b>	2.7mm ASYM Plate 68mm 5 Compression 3 Round Holes
<b>ASYM270306076</b>	2.7mm ASYM Plate 76mm 6 Compression 3 Round Holes
<b>ASYM270406076</b>	2.7mm ASYM Plate 76mm 6 Compression 4 Round Holes
<b>ASYM270307084</b>	2.7mm ASYM Plate 84mm 7 Compression 3 Round Holes
<b>ASYM270407084</b>	2.7mm ASYM Plate 84mm 7 Compression 4 Round Holes
<b>ASYM270308092</b>	2.7mm ASYM Plate 92mm 8 Compression 3 Round Holes
<b>ASYM270408092</b>	2.7mm ASYM Plate 92mm 8 Compression 4 Round Holes
<b>ASYM270309100</b>	2.7mm ASYM Plate 100mm 9 Compression 3 Round Holes
<b>ASYM270409100</b>	2.7mm ASYM Plate 100mm 9 Compression 4 Round Holes
<b>ASYM270310108</b>	2.7mm ASYM Plate 108mm 10 Compression 3 Round Holes
<b>ASYM270410108</b>	2.7mm ASYM Plate 108mm 10 Compression 4 Round Holes
<b>ASYM270311118</b>	2.7mm ASYM Plate 118mm 11 Compression 3 Round Holes
<b>ASYM270411118</b>	2.7mm ASYM Plate 118mm 11 Compression 4 Round Holes

### 3.5mm ASYM<sup>®</sup> Plates

<b>ASYM350304086</b>	3.5mm ASYM Plate 86mm 4 Compression 3 Round Holes
<b>ASYM350305098</b>	3.5mm ASYM Plate 98mm 5 Compression 3 Round Holes
<b>ASYM350306110</b>	3.5mm ASYM Plate 110mm 6 Compression 3 Round Holes
<b>ASYM350307122</b>	3.5mm ASYM Plate 122mm 7 Compression 3 Round Holes
<b>ASYM350406122</b>	3.5mm ASYM Plate 122mm 6 Compression 4 Round Holes
<b>ASYM350308134</b>	3.5mm ASYM Plate 134mm 8 Compression 3 Round Holes
<b>ASYM350407134</b>	3.5mm ASYM Plate 134mm 7 Compression 4 Round Holes
<b>ASYM350309146</b>	3.5mm ASYM Plate 146mm 9 Compression 3 Round Holes
<b>ASYM350408146</b>	3.5mm ASYM Plate 146mm 8 Compression 4 Round Holes
<b>ASYM350310158</b>	3.5mm ASYM Plate 158mm 10 Compression 3 Round Holes
<b>ASYM350409158</b>	3.5mm ASYM Plate 158mm 9 Compression 4 Round Holes
<b>ASYM350311170</b>	3.5mm ASYM Plate 170mm 11 Compression 3 Round Holes
<b>ASYM350410170</b>	3.5mm ASYM Plate 170mm 10 Compression 4 Round Holes
<b>ASYM350312182</b>	3.5mm ASYM Plate 182mm 12 Compression 3 Round Holes
<b>ASYM350411182</b>	3.5mm ASYM Plate 182mm 11 Compression 4 Round Holes

### 3.5mm ASYM<sup>®</sup> Broad Plates

<b>ASYMB350304086</b>	3.5mm Broad ASYM Plate 86mm 4 Compression 3 Round Holes
<b>ASYMB350305098</b>	3.5mm Broad ASYM Plate 98mm 5 Compression 3 Round Holes
<b>ASYMB350306110</b>	3.5mm Broad ASYM Plate 110mm 6 Compression 3 Round Holes
<b>ASYMB350406122</b>	3.5mm Broad ASYM Plate 122mm 6 Compression 4 Round Holes
<b>ASYMB350307122</b>	3.5mm Broad ASYM Plate 122mm 7 Compression 4 Round Holes
<b>ASYMB350407134</b>	3.5mm Broad ASYM Plate 134mm 7 Compression 4 Round Holes
<b>ASYMB350308134</b>	3.5mm Broad ASYM Plate 134mm 8 Compression 3 Round Holes
<b>ASYMB350408146</b>	3.5mm Broad ASYM Plate 146mm 8 Compression 4 Round Holes
<b>ASYMB350309146</b>	3.5mm Broad ASYM Plate 146mm 9 Compression 3 Round Holes
<b>ASYMB350409158</b>	3.5mm Broad ASYM Plate 158mm 9 Compression 4 Round Holes
<b>ASYMB350310158</b>	3.5mm Broad ASYM Plate 158mm 10 Compression 3 Round Holes
<b>ASYMB350410170</b>	3.5mm Broad ASYM Plate 170mm 10 Compression 4 Round Holes
<b>ASYMB350311170</b>	3.5mm Broad ASYM Plate 170mm 11 Compression 3 Round Holes
<b>ASYMB350411182</b>	3.5mm Broad ASYM Plate 182mm 11 Compression 4 Round Holes
<b>ASYMB350312182</b>	3.5mm Broad ASYM Plate 182mm 12 Compression 3 Round Holes

## Cuttable Plates

Available in 1.0mm to 3.5mm sizes, the versatility of these plates lies in their close hole spacing & they can be cut to length intra-op. They are not as stiff or as strong as compression plates of the equivalent size so they are often used in conjunction with other fixation methods e.g. in combination with IM pinning, double plating including stacked plating, edge-loaded, or where elastic osteogenesis is considered advantageous.

Please see page 87 for the 1.0mm range of Cuttable Plates.

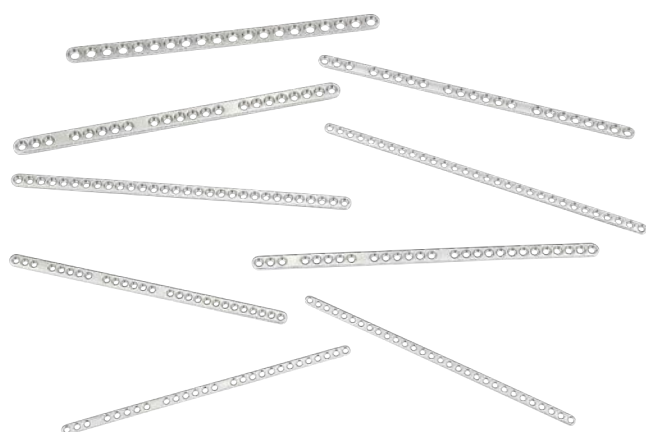

### Cuttable Plates Standard Spacing



- CP15413030** Cuttable Plate 1.5/2.0 Screws 30 Holes 120 mm Long
- CP205150** Cuttable Plate 2.0 Screws 30 Holes 150 mm Long
- CP2455150** Cuttable Plate 2.4 Screws 27 Holes 150mm Long
- CP276150** Cuttable Plate 2.7 Screws 25 Holes 150 mm Long
- CP3575150** Cuttable Plate 3.5 Screws 20 Holes 150 mm Long

### Cuttable Plates Standard Spacing Broad

- CP15413030B** Cuttable Broad 1.5mm Plate 1.5 Screws 30 Holes 121mm Long
- CP205150B** Cuttable Broad 2.0mm Plate 2.0 Screws 30 Holes 150mm Long
- CP276150B** Cuttable Broad 2.7mm Plate 2.7 Screws 25 Holes 150mm Long

### Cuttable Plates With Spaces



- CP15413027** Cuttable Plate With Spaces 1.5/2.0mm Screws 27 Holes 120mm Long
- CP20515027** Cuttable Plate With Spaces 2.0mm Screws 27 Holes 150mm Long
- CP245515024** Cuttable Plate With Spaces 2.4mm Screws 24 Holes 150mm Long
- CP27615022** Cuttable Plate With Spaces 2.7mm Screws 22 Holes 150mm Long
- CP357515018** Cuttable Plate With Spaces 3.5mm Screws 18 Holes 150mm Long

### Cuttable Plates With Spaces Broad

- CP15413027B** Cuttable Plate Broad With Spaces 1.5mm Screws 27 Holes 121mm Long
- CP20515027B** Cuttable Plate Broad With Spaces 2.0mm Screws 27 Holes 150mm Long
- CP27615022B** Cuttable Plate Broad With Spaces 2.7mm Screws 22 Holes 150mm Long

## Veterinary Cuttable Plates



- VCP202427** 2.0mm/2.4mm/2.7mm Cuttable Plate 300mm 50 Holes
- VCP202427B** 2.0mm/2.4mm/2.7mm Cuttable Broad Plate 300mm 50 Holes

## Double Compression Cuttable Plates



- DCCP206150** Double Comp Cuttable Plate 2.0mm 25 Holes 150mm Long
- DCCP247150** Double Comp Cuttable Plate 2.4mm 21 Holes 150mm Long
- DCCP278150** Double Comp Cuttable 2.7 Plate 19 Holes 150 mm Long

## Cuttable Malleable Plates



- CM15413030** Cuttable Malleable Plate 1.5mm Screws 30 Holes 121mm Long
- CM205150** Cuttable Malleable Plate 2.0mm Screws 30 Holes 150mm Long
- CM2455150** Cuttable, Malleable Plate 2.4mm Screws 27 Holes 150mm Long
- CM276150** Cuttable Malleable Plate 2.7mm Screws 25 Holes 150mm Long
- CM3575150** Cuttable Malleable Plate 3.5mm Screws 20 Holes 150mm Long

## Cuttable Malleable Locking Plates



- CM15LOCK** 1.5mm Cuttable Malleable Locking Plate 15 Holes 74mm Long
- CM20LOCK** 2.0mm Cuttable Malleable Locking Plate 15 Holes 103mm Long
- CM24LOCK** 2.4mm Cuttable Malleable Locking Plate 15 Holes 125mm Long
- CM27LOCK** 2.7mm Cuttable Malleable Locking Plate 15 Holes 148mm Long
- CM35LOCK** 3.5mm Cuttable Malleable Locking Plate 15 Holes 205mm Long

Please note, Cuttable Malleable Plates & Cuttable Malleable Locking Plates are not suitable for weight bearing fractures unless used in conjunction with other plates.

For scaled plate profiles, please view the Plate Profile chapter.

## Round Hole Plates

A traditional style of plate that may still have useful applications where budget is a concern. Also may be useful where axial compression is not desirable or achievable, the round holes may provide a more stable screw/plate interface & the closer hole spacing can be useful for small fragments. More modern plating solutions may be preferable.



### 2.0mm Round Hole Plates

PR200213	2mm Round Hole Plate 13mm 2 Hole
PR200420	2mm Round Hole Plate 20mm 4 Hole
PR200423	2mm Round Hole Plate 23mm 4 Hole
PR200525	2mm Round Hole Plate 25mm 5 Hole
PR200528	2mm Round Hole Plate 28mm 5 Hole
PR200630	2mm Round Hole Plate 30mm 6 Hole
PR200633	2mm Round Hole Plate 33mm 6 Hole
PR200738	2mm Round Hole Plate 38mm 7 Hole
PR200840	2mm Round Hole Plate 40mm 8 Hole
PR200843	2mm Round Hole Plate 43mm 8 Hole

### 2.7mm Round Hole Plates

PR270215	2.7mm Round Hole Plate 15mm 2 Hole
PR270427	2.7mm Round Hole Plate 27mm 4 Hole
PR270530	2.7mm Round Hole Plate 30mm 5 Hole
PR270533	2.7mm Round Hole Plate 33mm 5 Hole
PR270636	2.7mm Round Hole Plate 36mm 6 Hole
PR270639	2.7mm Round Hole Plate 39mm 6 Hole
PR270742	2.7mm Round Hole Plate 42mm 7 Hole
PR270745	2.7mm Round Hole Plate 45mm 7 Hole
PR270848	2.7mm Round Hole Plate 48mm 8 Hole
PR270851	2.7mm Round Hole Plate 51mm 8 Hole

### 2.7mm Round Hole Heavy Duty Plates

HPR270744	2.7mm Heavy Duty Round Hole Plate 44mm 7 Hole
HPR270750	2.7mm Heavy Duty Round Hole Plate 50mm 7 Hole
HPR270850	2.7mm Heavy Duty Round Hole Plate 50mm 8 Hole
HPR270856	2.7mm Heavy Duty Round Hole Plate 56mm 8 Hole
HPR270956	2.7mm Heavy Duty Round Hole Plate 56mm 9 Hole
HPR270962	2.7mm Heavy Duty Round Hole Plate 62mm 9 Hole
HPR271068	2.7mm Heavy Duty Round Hole Plate 68mm 10 Hole
HPR271168	2.7mm Heavy Duty Round Hole Plate 68mm 11 Hole
HPR271174	2.7mm Heavy Duty Round Hole Plate 74mm 11 Hole
HPR271280	2.7mm Heavy Duty Round Hole Plate 80mm 12 Hole

### 3.5mm Round Hole Plates

P3504046	3.5mm Round Hole Plate 46mm 4 Hole
P3504052	3.5mm Round Hole Plate 52mm 4 Hole
P3505058	3.5mm Round Hole Plate 58mm 5 Hole
P3505064	3.5mm Round Hole Plate 64mm 5 Hole
P3506070	3.5mm Round Hole Plate 70mm 6 Hole
P3506076	3.5mm Round Hole Plate 76mm 6 Hole
P3507082	3.5mm Round Hole Plate 82mm 7 Hole
P3507088	3.5mm Round Hole Plate 88mm 7 Hole
P3508100	3.5mm Round Hole Plate 100mm 8 Hole
P3509106	3.5mm Round Hole Plate 106mm 9 Hole
P3509118	3.5mm Round Hole Plate 118mm 9 Hole
P3510118	3.5mm Round Hole Plate 118mm 10 Hole
P3510130	3.5mm Round Hole Plate 130mm 10 Hole

### 3.5mm Round Hole Heavy Duty Plates

H3508104	3.5mm Heavy Duty Round Hole Plate 104mm 8 Hole
H3510130	3.5mm Heavy Duty Round Hole Plate 130mm 10 Hole
H3513169	3.5mm Heavy Duty Round Hole Plate 169mm 13 Hole
H3514180	3.5mm Heavy Duty Round Hole Plate 180mm 14 Hole
H3515195	3.5mm Heavy Duty Round Hole Plate 195mm 15 Hole

For scaled plate profiles, please view the Plate Profile chapter.

## Biological Healing Plates

A traditional style of plate that may still have useful applications where budget is a concern. The solid, stiff midsection is designed to bridge a non-reconstructable fracture. More modern plating solutions may be preferable.



### 2.0mm Biological Healing Plates

<b>BHP2007060</b>	2.0mm 7 Hole 60mm Long
<b>BHP2008065</b>	2.0mm 8 Hole 65mm Long
<b>BHP2008070</b>	2.0mm 8 Hole 70mm Long
<b>BHP2008075</b>	2.0mm 8 Hole 75mm Long
<b>BHP2008080</b>	2.0mm 8 Hole 80mm Long

### 2.7mm Biological Healing Plates

<b>BHP2706063</b>	2.7mm 6 Hole 63mm Long
<b>BHP2707073</b>	2.7mm 7 Hole 73mm Long
<b>BHP2707079</b>	2.7mm 7 Hole 79mm Long
<b>BHP2708075</b>	2.7mm 8 Hole 75mm Long
<b>BHP2708081</b>	2.7mm 8 Hole 81mm Long
<b>BHP2708085</b>	2.7mm 8 Hole 85mm Long

### 3.5mm Biological Healing Plates

<b>BHP3507120</b>	3.5mm 7 Hole 120mm Long
<b>BHP3507130</b>	3.5mm 7 Hole 130mm Long
<b>BHP3507142</b>	3.5mm 7 Hole 142mm Long
<b>BHP3508130</b>	3.5mm 8 Hole 130mm Long
<b>BHP3508142</b>	3.5mm 8 Hole 142mm Long
<b>BHP3508154</b>	3.5mm 8 Hole 154mm Long
<b>BHPB3508130</b>	Broad 3.5mm 8 Hole 130mm Long
<b>BHPB3508142</b>	Broad 3.5mm 8 Hole 142mm Long
<b>BHPB3507142</b>	Broad 3.5mm 7 Hole 142mm Long
<b>BHPB3508154</b>	Broad 3.5mm 8 Hole 154mm Long

### 4.5mm Biological Healing Plates

<b>BHP4507138</b>	4.5mm 7 Hole 138mm Long
<b>BHP4507151</b>	4.5mm 7 Hole 151mm Long
<b>BHP4507164</b>	4.5mm 7 Hole 164mm Long
<b>BHP4508150</b>	4.5mm 8 Hole 150mm Long
<b>BHP4508176</b>	4.5mm 8 Hole 176mm Long

## Reconstruction Plates

A traditional style of plate, easy to contour in multiple directions, Reconstruction Plates are both stronger & stiffer than the cuttable malleable plates, but less strong & stiff than compression plates. Typically these plates are used as neutralisation plates where the surface anatomy of the bone is challenging to accurately contour a regular plate over e.g. the humeral condyle or the pelvis.



### 2.7mm Reconstruction Plates

<b>RC270648</b>	2.7mm Reconstruction Plate 48mm 6 Hole
<b>RC270756</b>	2.7mm Reconstruction Plate 56mm 7 Hole
<b>RC270864</b>	2.7mm Reconstruction Plate 64mm 8 Hole
<b>RC270972</b>	2.7mm Reconstruction Plate 72mm 9 Hole
<b>RC271080</b>	2.7mm Reconstruction Plate 80mm 10 Hole
<b>RC271188</b>	2.7mm Reconstruction Plate 88mm 11 Hole
<b>RC271296</b>	2.7mm Reconstruction Plate 96mm 12 Hole

### 3.5mm Reconstruction Plates

<b>RC350558</b>	3.5mm Reconstruction Plate 58mm 5 Hole
<b>RC350782</b>	3.5mm Reconstruction Plate 82mm 7 Hole
<b>RC350894</b>	3.5mm Reconstruction Plate 94mm 8 Hole
<b>RC3509106</b>	3.5mm Reconstruction Plate 106mm 9 Hole
<b>RC3512142</b>	3.5mm Reconstruction Plate 142mm 12 Hole

For scaled plate profiles, please view the Plate Profile chapter.

## T-Plates

T-Plates are mainly used for distal radial fractures, but may also be useful in management of cranial, pelvic or certain scapula fractures. Locking T plates offer inherently better angular stability, which can be useful when managing small fragments.



## Locking T-Plates

### 1.5mm Locking T-Plate



**T1515836LOCK** 1.5mm Locking T-Plate 8 Holes 36mm Long

### 2.0mm Locking T-Plates



**T2020532LOCK** 2.0mm Locking T-Plate 5 Holes 32mm Long

**T2020632LOCK** 2.0mm Locking T-Plate 6 Holes 32mm Long

**T2020850LOCK** 2.0mm Locking T-Plate 8 Holes 50mm Long

### 2.4mm/2.7mm Locking T-Plates



**T240531LOCK** 2.4mm Locking T-Plate 5 Holes 37mm Long

**T2427537LOCK** 2.4mm/2.7mm Locking T-Plate 5 Holes 37mm Long

**T2427647LOCK** 2.4mm/2.7mm Locking T-Plate 6 Holes 47mm Long

**T2427755LOCK** 2.4mm/2.7mm Locking T-Plate 7 Holes 55mm Long

**T2427748LOCK** 2.4mm/2.7mm Locking T-Plate 3 Head 4 Shaft 48mm Long

### 3.5mm Locking T-Plates



**T350660LOCK** 3.5mm Locking T-Plate 6 Holes 66mm Long

**T350766LOCK** 3.5mm Locking T-Plate 3 Head 4 Shaft 60mm

**T350880LOCK** 3.5mm Locking T-Plate 8 Holes 80mm Long

**T3510100LOCK** 3.5mm Locking T-Plate 10 Holes 100mm Long

**T3512120LOCK** 3.5mm Locking T-Plate 12 Holes 120mm Long

## Compression T-Plates



### 1.5mm Compression T-Plates

**T151520** 1.5mm 2 Holes Head 3 Holes Shaft 20mm Long

**T151525** 1.5mm 2 Holes Head 4 Holes Shaft 25mm Long

**T1515626** 1.5mm 3 Holes Head 3 Holes Shaft 26mm Long

**T1515731** 1.5mm 3 Holes Head 4 Holes Shaft 31mm Long

**T1515836** 1.5mm 3 Holes Head 5 Holes Shaft 36mm Long

**T1515940** 1.5mm 3 Holes Head 6 Holes Shaft 40mm Long

### 2.0mm Compression T-Plates

**T202025** 2.0mm T-Plate 1.5 or 2.0mm Head 2.0mm Shaft 25mm Long  
Shaft Width 5.1mm Shaft Thickness 1.5mm

**T202027** 2.0mm T-Plate 1.5 or 2.0mm Head 2.0mm Shaft 27mm Long  
Shaft Width 5.1mm Shaft Thickness 1.5mm

**T202032** 2.0mm T-Plate 1.5 or 2.0mm Head 2.0mm Shaft 32mm Long  
Shaft Width 5.1mm Shaft Thickness 1.5mm

**T2020636** 2.0mm T-Plate 1.5 or 2.0mm Head 2.0mm Shaft 36mm Long  
Shaft Width 5.1mm Shaft Thickness 1.5mm

**T2020742** 2.0mm T-Plate 1.5 or 2.0mm Head 2.0mm Shaft 42mm Long  
Shaft Width 5.1mm Shaft Thickness 1.5mm

**T202042** 2.0mm T-Plate 1.5 or 2.0mm Head 2.0mm Shaft 42mm Long 8  
Hole Shaft Width 5.1mm Shaft Thickness 1.5mm

**T202050** 2.0mm T-Plate 1.5 or 2.0mm Head 2.0mm Shaft 50mm Long 8  
Hole Shaft Width 5.1mm Shaft Thickness 1.5mm

**T2020750** 2.0mm T-Plate 1.5 or 2.0mm Head 2.0mm Shaft 50mm Long 7  
Hole Shaft Width 5.1mm Shaft Thickness 1.5mm

### 2.4mm Compression T-Plates

**T240531** 2.4mm T-Plate 5 Holes 31mm Long

**T240638** 2.4mm T-Plate 6 Holes 38mm Long

**T240744** 2.4mm T-Plate 7 Holes 44mm Long

**T240853** 2.4mm T-Plate 8 Holes 53mm Long

**T240858** 2.4mm T-Plate 8 Holes 58mm Long

**T240958** 2.4mm T-Plate 9 Holes 58mm Long

**T241072** 2.4mm T-Plate 10 Holes 72mm Long

**T241172** 2.4mm T-Plate 11 Holes 72mm Long

### 2.7mm Compression T-Plates

**T270535** 2.7mm T-Plate 5 Holes 35mm Long

**T270643** 2.7mm T-Plate 6 Holes 43mm Long

**T270749** 2.7mm T-Plate 7 Holes 49mm Long

**T270857** 2.7mm T-Plate 8 Holes 57mm Long

**T270967** 2.7mm T-Plate 9 Holes 67mm Long

**T270973** 2.7mm T-Plate 9 Holes 73mm Long

**T271073** 2.7mm T-Plate 10 Holes 73mm Long

**T271191** 2.7mm T-Plate 11 Holes 91mm Long

**T271291** 2.7mm T-Plate 12 Holes 91mm Long

**T271297** 2.7mm T-Plate 12 Holes 97mm Long

**T271397** 2.7mm T-Plate 13 Holes 97mm Long

For scaled plate profiles, please view the Plate Profile chapter.

## Combi T-Plates



The Vi Combi T-Plates have been created as an extension of our current T-Plate range. The general shape of the plate is very similar, and this plate comes with the added benefit of locking technology. There are stacked locking holes in the distal end of the plate and dynamic locking holes in the shaft.

### Key Features & Benefits:

- Locking construct increases stability
- Stacked locking hole allows placement of either a locking or non-locking screw
- Dynamic Locking holes in proximal section
- K-wire hole
- Available in a range of lengths
- Manufactured from Stainless Steel

## 1.5mm Combi T-Plates

- T151532COMBI** 1.5mm Combi T-Plate 32.5mm Long 6 Holes  
**T1515735COMBI** 1.5mm Combi T-Plate 35.5mm Long 7 Holes  
**T1515947COMBI** 1.5mm Combi T-Plate 47mm Long 9 Holes  
**T15151159COMBI** 1.5mm Combi T-Plate 59mm Long 11 Holes

## 2mm Combi T-Plates

- T202033COMBI** 2mm Combi T-Plate 33mm Long 5 Holes  
**T202040COMBI** 2mm Combi T-Plate 40mm Long 6 Holes  
**T2020743COMBI** 2mm Combi T-Plate 43.5mm Long 7 Holes  
**T2020850COMBI** 2mm Combi T-Plate 50.5mm Long 8 Holes  
**T20201065COMBI** 2mm Combi T-Plate 65mm Long 10 Holes  
**T20201279COMBI** 2mm Combi T-Plate 79mm Long 12 Holes



## 2.4mm Combi T-Plates

- T242407059COMBI** 2.4mm Combi T-Plate 59mm Long 7 Holes  
**T242408068COMBI** 2.4mm Combi T-Plate 68mm Long 8 Holes  
**T242409077COMBI** 2.4mm Combi T-Plate 77mm Long 9 Holes

## 2.7mm Combi T-Plates

- T272708076COMBI** 2.7mm Combi T-Plate 76mm Long 8 Holes  
**T272709086COMBI** 2.7mm Combi T-Plate 86mm Long 9 Holes  
**T272710096COMBI** 2.7mm Combi T-Plate 96mm Long 10 Holes

## 3.5mm Combi T-Plates

- T353507082COMBI** 3.5mm Combi T-Plate 82mm Long 7 Holes  
**T353508094COMBI** 3.5mm Combi T-Plate 94mm Long 8 Holes  
**T353510119COMBI** 3.5mm Combi T-Plate 119mm Long 10 Holes

For scaled plate profiles, please view the Plate Profile chapter.

Scan the QR code below to be the first to hear about our upcoming new plate ranges.



## Training & Education

Our **e-learning platform** delivers a variety of technical and clinical educational material, in an engaging and interactive format.

With a CPD certificate awarded upon successful completion of each module, the e-learning platform from Vi will help you to fulfil your annual CPD requirements.

Sign up today by scanning the QR code below.



## Hybrid Anatomical T-Plates



### 2.0mm Hybrid Anatomical T-Plates

- T2027755** Hybrid Anatomical T-Plate 3x 2mm Head Screws  
4x 2.7mm Shaft Screws 55mm Long
- T2027758** Hybrid Anatomical T-Plate 3x 2mm Head Screws  
4x 2.7mm Shaft Screws 58mm Long

### 2.7mm Hybrid Anatomical T-Plates

- T273572** Hybrid Anatomical T-Plate 3x 2.7mm Head Screws  
4x 3.5mm Shaft Screws 72mm Long
- T273576** Hybrid Anatomical T-Plate 3x 2.7mm Head Screws  
4x 3.5mm Shaft Screws 76mm Long

### 3.5mm Hybrid Anatomical T-Plates

- T3545795** Hybrid Anatomical T-Plate 3x 3.5mm Head Screws  
4x 4.5mm Shaft Screws 95mm Long
- T3545799** Hybrid Anatomical T-Plate 3x 3.5mm Head Screws  
4x 4.5mm Shaft Screws 99mm Long

## Hybrid T-Plates



### 1.5mm Hybrid T-Plates

- T152034** Hybrid T-Plate - 1.5 Or 2.0mm Head  
2.0mm Shaft 34mm Long Cuttable  
Shaft Width 4.5mm Shaft Thickness 1.1mm

### 2.0mm Hybrid T-Plates

- T20242736** Hybrid T-Plate - 2.0, 2.4 Or 2.7mm Head  
2.0 2.4 Or 2.7mm Shaft 36mm Long  
Shaft Width 7.4mm Shaft Thickness 2mm
- T20242744** Hybrid T-Plate - 2.0, 2.4 Or 2.7mm Head  
2.0, 2.4 Or 2.7mm Shaft 44mm Long  
Shaft Width 7.4mm Shaft Thickness 2mm
- T20242752** Hybrid T-Plate - 2.0, 2.4 Or 2.7mm Head  
2.0 2.4 Or 2.7mm Shaft 52mm Long  
Shaft Width 7.4mm Shaft Thickness 2mm
- T20242771** Hybrid T-Plate - 2.0, 2.4 Or 2.7mm Head  
2.0 2.4 Or 2.7mm Shaft 71mm Long  
Shaft Width 7.4mm Shaft Thickness 2mm

### 2.7mm Hybrid T-Plates

- T273562** Hybrid T-Plate - 2.7 Or 3.5mm Head  
3.5mm Shaft 62mm Long  
Shaft Width 9.5mm Shaft Thickness 2mm
- T273585** Hybrid T-Plate - 2.7 Or 3.5mm Head  
3.5mm Shaft 85mm Long  
Shaft Width 9.5mm Shaft Thickness 2mm

## T-Plates Clover Leaf



### 2.0mm T-Plates Clover Leaf

- TPLO202026** 2.0mm DCP 26mm Overall Length
- TPLO202031** 2.0mm DCP 31mm Overall Length

### 2.4mm T-Plates Clover Leaf

- TPLO242434** 2.4mm DCP 34mm Overall Length
- TPLO242441** 2.4mm DCP 41mm Overall Length

### 2.7mm T-Plates Clover Leaf

- TPLO272739** 2.7mm DCP 39mm Overall Length
- TPLO272745** 2.7mm DCP 45mm Overall Length
- TPLO273539** 2.7/3.5 DCP 39mm Overall Length  
Allows Use Of 3.5 Cancellous Screw In Head
- TPLO273545** 2.7/3.5 DCP 45mm Overall Length  
Allows Use Of 2.7 & 3.5 Screws In Head 2.5mm Thick

### 3.5mm T-Plates Clover Leaf

- TPLO353555** 3.5mm DCP 55mm Overall Length
- TPLO353557** 3.5mm DCP 57mm Overall Length Heavy Duty
- TPLO353559** 3.5mm DCP 59mm Overall Length
- TPLO353562** 3.5mm DCP 62mm Overall Length
- TPLO353565** 3.5mm DCP 65mm Overall Length
- TPLO353577** 3.5mm DCP 77mm Overall Length 7 Holes
- TPLO353577X** 3.5mm DCP 77mm Overall Length 8 Holes
- TPLO353579** 3.5mm DCP 79mm Overall Length Heavy Duty
- TPLO354579** 3.5/4.5 DCP 79mm Overall Length Heavy Duty  
Allows 4.5 Screws In Head
- TPLO35456579** 3.5/4.5 DCP 79mm Overall Length Heavy Duty  
Will Accept 6.5 Cancellous Screws In Head 4.5mm Thick

### 4.5mm T-Plates Clover Leaf

- TPLO45659030** 4.5mm DCP 90mm Overall Length  
Will Accept 6.5 Cancellous Screws In Head 3.0mm Thick
- TPLO45659035** 4.5/6.5mm DCP 90mm Overall Length  
Will Accept 6.5 Cancellous Screws In Head 3.5mm Thick
- TPLO45659045** 4.5mm DCP 90mm Overall Length  
Will Accept 6.5 Cancellous Screws In Head 4.5mm Thick

## T-Plates Round Hole

- TC204018** 2mm T-Plate 4 Hole 18mm 2 Holes Distally
- TC205024** 2mm T-Plate 5 Hole 24mm 2 Holes Distally
- OR270532** 2.7mm T-Plate 5 Hole 32mm Oblique R 2 Holes Distally
- TC270639** 2.7mm T-Plate 6 Hole 39mm 2 Holes Distally
- TC350655** 3.5mm T-Plate 6 Hole 55mm 2 Holes Distally
- TC350662** 3.5mm T-Plate 6 Hole 62mm 2 Holes Distally
- TC350777** 3.5mm T-Plate 7 Hole 77mm 2 Holes Distally
- TC350877** 3.5mm T-Plate 8 Hole 77mm 2 Holes Distally

For scaled plate profiles, please view the Plate Profile chapter.



## Supracondylar Plates

Supracondylar femoral fractures in mature animals can be very difficult to repair. Small distal fragment size makes placement of sufficient implants a challenge, & there are often multiple small fragments in the supracondylar area. The forces acting on the distal femur are complex requiring a special plate to neutralise them. The original plates were developed by Mark Glyde using finite element analysis & an extra long version for cats has been developed in conjunction with Sorrel Langley-Hobbs.



### 1.5mm Supracondylar Plates

- I52704** 1.5mm Supracondylar Plate 3 Distal Hole Right  
**I52703** 1.5mm Supracondylar Plate 3 Distal Hole Left

### 2.0mm Supracondylar Plates

- I52701** Supracondylar Plate 2.0mm - Short Distal End - Right  
**I52709** Supracondylar Plate 2.0mm - Short Distal End - Left  
**I52700** Supracondylar Plate 2.0mm 50mm Long - Right - Shaft Width 5.5mm  
 Shaft Thickness 2.0mm  
**I52710** Supracondylar Plate 2.0mm 50mm Long - Left - Shaft Width 5.5mm  
 Shaft Thickness 2.0mm  
**I52700XL** Supracondylar Plate 2.0mm 120mm Extra Long  
 Cuttable Right Shaft Width 5.5mm Shaft Thickness 2mm  
**I52710XL** Supracondylar Plate 2.0mm 120mm Extra Long  
 Cuttable Left Shaft Width 5.5mm Shaft Thickness 2mm

### 2.4mm Supracondylar Plates

- I52711R** Supracondylar Plate 2.4mm 62mm Long Right  
 Shaft Width 6.5mm Shaft Thickness 2mm  
**I52711L** Supracondylar Plate 2.4mm 62mm Long Left  
 Shaft Width 6.5mm Shaft Thickness 2mm  
**I52711R-XL** Supracondylar Plate 2.4mm 112mm Extra Long  
 Right Shaft Width 6.5mm Shaft Thickness 2mm  
**I52711L-XL** Supracondylar Plate 2.4mm 112mm Extra Long  
 Left Shaft Width 6.5mm Shaft Thickness 2mm

### 2.7mm Supracondylar Plates

- I52712** Supracondylar Plate 2.7mm Left 69mm Long  
**I52714** Supracondylar Plate 2.7mm Right 69mm Long

### 3.5mm Supracondylar Plates

- I52715N** Supracondylar Plate 3.5mm Narrow Left 135mm Long  
**I52717N** Supracondylar Plate 3.5mm Narrow Right 135mm Long  
**I52715** Supracondylar Plate 3.5mm Broad Left 135mm Long  
**I52717** Supracondylar Plate 3.5mm Broad Right 135mm Long  
**I52716** Supracondylar Femur 3.5mm Broad Left 173mm Long  
**I52718** Supracondylar Femur 3.5mm Broad Right 173mm Long

## Supracondylar Osteotomy Plates (SCOP)

Angular correction of the distal femur by means of a supracondylar osteotomy (distal femoral osteotomy/DFO) is an accepted technique for correction of patella luxation in medium & large dogs with a limb alignment deformity. The distal femur is a difficult area over which to appropriately contour a plate & place sufficient screws. Using finite element analysis (FEA), Mark Glyde designed a preformed plate specifically for this area. Our SCOP plates feature thinning to the proximal end & smoothing to cranio-distal edge over which there is high motion during stifle flexion/extension.



### 2.0mm Supracondylar Osteotomy Plates

- I52608** 2.0mm Supracondylar Osteotomy Plate Right  
**I52609** 2.0mm Supracondylar Osteotomy Plate Left  
**I52612** 2.0mm Supracondylar Osteotomy Plate Short Distal End Right  
**I52613** 2.0mm Supracondylar Osteotomy Plate Short Distal End Left

### 2.4mm Supracondylar Osteotomy Plates

- I52606** 2.4mm Supracondylar Osteotomy Plate Right  
**I52607** 2.4mm Supracondylar Osteotomy Plate Left

### 2.7mm Supracondylar Osteotomy Plates

- I52600** 2.7mm Supracondylar Osteotomy Plate Right  
**I52605** 2.7mm Supracondylar Osteotomy Plate Left

### 3.5mm Supracondylar Osteotomy Plates

- I52610** 3.5mm Supracondylar Osteotomy Plate Right  
**I52615** 3.5mm Supracondylar Osteotomy Plate Left  
**I52620** 3.5mm Broad Supracondylar Osteotomy Plate Right  
**I52625** 3.5mm Broad Supracondylar Osteotomy Plate Left

## Bending Templates



- BT I52700** Bending Template for 2.0mm Supracondylar Plate  
**BT I52711** Bending Template for 2.4mm Supracondylar Plate  
**BT I52714** Bending Template for 2.7mm Supracondylar Plate  
**BT I52717** Bending Template for 3.5mm Supracondylar Plate

### 2.0mm Locking Supracondylar Plates



- I52608COMBI** Feline 2mm Combi Supracondylar Plate Right  
**I52609COMBI** Feline 2mm Combi Supracondylar Plate Left

## Acetabular Plates

Accurate repair of fractures of the acetabulum is essential if full function is to be restored & long term arthritic changes are to be avoided. Ten sizes are available. These round-holed plates are pre-contoured three dimensionally to ensure a good fit.



### 2.0mm Acetabular Plates

- AP200400XS**     2.0mm Acetabular Plate 4 Hole Extra Small
- AP200400**     2.0mm Acetabular Plate 4 Hole Size 0
- AP200401**     2.0mm Acetabular Plate 4 Hole Size 1
- AP200401L**     2.0mm Acetabular Plate 4 Hole Large

### 2.4mm Acetabular Plate

- AP240406**     2.4mm Acetabular Plate 4 Hole

### 2.7mm Acetabular Plates

- AP270602**     2.7mm Acetabular Plate 6 Hole Size 2
- AP270603**     2.7mm Acetabular Plate 6 Hole Size 3

### 3.5mm Acetabular Plates

- AP350604**     3.5mm Acetabular Plate 6 Hole Size 4
- AP350605**     3.5mm Acetabular Plate 6 Hole Size 5
- AP350607**     3.5mm Acetabular Plate 6 Hole Extra Large

### Acetabular Plate Set

- APSET**     Acetabular Plates Set of 10 (One Of Each Of The Plates Listed Above)

## Butterfly Plates

A novel plate design with potential use across a range of procedures such as revision/embrocation of TTA repairs, cranial surgery & pelvic surgery.



### 1.5mm Non-Locking Butterfly Plates

- BTFP15414**     1.5mm Butterfly Plate 4 Hole 14mm Length

### 2.0mm Non-Locking Butterfly Plates

- BTFP20623**     2.0mm Butterfly Plate 6 Hole 23mm Length

For scaled plate profiles, please view the Plate Profile chapter.

## Carpal Arthrodesis Plates

Our comprehensive range of plates for carpal arthrodesis take into account the challenges of this procedure & are designed for the dorsal approach.

- Appropriately sized & spaced screw-holes proximally & distally.
- Sufficient strength through the mid-portion.
- Thinning to the distal portion reducing stress riser effects & aiding skin closure.

### Partial Carpal Arthrodesis Plates



#### 1.5/2.0mm Partial Carpal Arthrodesis Plates

I52932 Partial Carpal Arthrodesis Plate 1.5/2.0mm

#### 2.0/2.4/2.7mm Partial Carpal Arthrodesis Plates

I52931 Partial Carpal Arthrodesis Plate 2.0/2.4/2.7mm 50mm

#### 2.7/3.5mm Partial Carpal Arthrodesis Plates

I52930 Partial Carpal Arthrodesis Plate 2.7/3.5mm 65mm

### Round Hole Pancarpal Arthrodesis Plates

#### 2.7/3.5mm Round Hole Pancarpal Arthrodesis Plates

I52904 2.7mm/3.5mm Carpal Arthrodesis Plate 100mm Rnd  
I52904XL 2.7mm/3.5mm Carpal Arthrodesis Plate 116mm XL Rnd

#### 3.5mm Locking & DCP Hybrid Pancarpal Arthrodesis Plates

I52907XLL 3.5mm Locking & DCP Hybrid Pancarpal Arthrodesis Plate 153mm

### Locking Pancarpal Arthrodesis Plates



#### 1.5/2.0mm Locking Pancarpal Arthrodesis Plates

PCALK1520 1.5/2.0mm Locking Pancarpal Arthrodesis Plate  
PCALK1520L 1.5/2.0mm Locking Pancarpal Arthrodesis Plate - Long

#### 2.0/2.4mm Locking Pancarpal Arthrodesis Plates

PCALK2024 2.0/2.4mm Locking Pancarpal Arthrodesis Plate  
PCALK2024L 2.0/2.4mm Locking Pancarpal Arthrodesis Plate - Long

### 2.0/2.7mm Locking Pancarpal Arthrodesis Plates

PCALK2027 2.0/2.7mm Locking Pancarpal Arthrodesis Plate  
PCALK2027L 2.0/2.7mm Locking Pancarpal Arthrodesis Plate - Long

### 2.7/3.5mm Locking Pancarpal Arthrodesis Plates

PCALK2735 2.7/3.5mm Locking Pancarpal Arthrodesis Plate  
PCALK2735L 2.7/3.5mm Locking Pancarpal Arthrodesis Plate - Long

### DCP Style Pancarpal Arthrodesis Plates



#### 1.0/1.5mm DCP Pancarpal Arthrodesis Plates

I52970 1.0/1.5mm Pancarpal Arthrodesis Plate  
I52970B 1.0/1.5mm Pancarpal Arthrodesis Plate Broad

#### 1.5/2.0mm DCP Style Pancarpal Arthrodesis Plates

I52911 1.5mm/2.0mm Compression Arthrodesis Plate  
I52911XL 1.5mm/2.0mm Compression Extended Length

#### 2.0/2.0mm DCP Style Pancarpal Arthrodesis Plates

I52912 2.0mm/2.0mm Compression Arthrodesis Plate  
I52912XL 2.0mm/2.0mm Compression Extended Length

#### 2.0/2.7mm DCP Style Pancarpal Arthrodesis Plates

I52902 2.0mm/2.7mm Compression Arthrodesis Plate  
I52905 2.0mm/2.7mm Compression Arthrodesis Plate  
I52905XL 2.0mm/2.7mm Compression Extended Length 90mm  
I52905XLI5 2.0mm/2.7mm Compression XXL 130mm

#### 2.7/3.5/4.5mm DCP Style Pancarpal Arthrodesis Plates

I52903 2.7mm/3.5mm Compression Arthrodesis Plate  
I52903XL 2.7mm/3.5mm Compression Extended Length  
I52907 3.5mm/3.5mm Compression Arthrodesis Plate  
PCA2735XL 2.7mm/3.5mm Pancarpal Arthrodesis Plate Extra Long  
I52907XL 3.5mm/3.5mm Compression Extended Length  
I52981 3.5mm Compression Arthrodesis Plate With 9x Proximal Slots  
I52909 3.5mm/4.5mm Pancarpal Arthrodesis Plate 185mm

### 3.5mm Compression Arthrodesis Plates

I52981 3.5mm Compression Arthrodesis Plate with 9x Proximal Slots

For scaled plate profiles, please view the Plate Profile chapter.

## Tarsal Arthrodesis Plates

Our comprehensive range of plates for tarsal arthrodesis take account of the challenges of this procedure. Plates are available for both the medial & dorsal approaches. Medial plates are available either with or without the T4 slot, & a titanium medial plate is available in one size. Plate angulation is set to match the normal standing angles of the target patient population.

Our original range of medial pantarsal arthrodesis plates were developed from custom implants supplied to Malcolm McKee, & improvements subsequently have been made to this original design. The Dorsal Pantarsal Arthrodesis Plate was developed in collaboration with Noel Fitzpatrick & allows the surgeon to benefit from the advantages of dorsal placement, whilst minimising the risks of failure.

## Dorsal Pantarsal Arthrodesis Plates



### Feline Dorsal Pantarsal Arthrodesis Plate

**I52941** Feline Dorsal Pantarsal Arthrodesis Plate 2.0mm/2.0mm  
Calcaneal Holes Accept 2.0mm Or 2.4mm Screws

### Canine Dorsal Pantarsal Arthrodesis Plate

**I52946** Canine Dorsal Pantarsal Arthrodesis Plate 2.4mm/2.7mm/3.5mm

## Partial Tarsal Arthrodesis Plates



### 1.5/2.0mm Partial Tarsal Arthrodesis Plates

**I52924** Partial Tarsal Arthrodesis Plate 1.5mm/2.0mm  
**I52923** Partial Tarsal Arthrodesis Plate 2.0mm/2.0mm

### 2.0/2.7mm Partial Tarsal Arthrodesis Plates

**I52920** Partial Tarsal Arthrodesis Plate 2.0mm/2.7mm  
**I52922** Partial Tarsal Arthrodesis Plate 2.7mm/2.7mm  
**I52920SC** Partial Tarsal Arthrodesis Plate 2.0mm/2.7mm Short Calcaneous

### 2.7/3.5mm Partial Tarsal Arthrodesis Plates

**I52921** Partial Tarsal Arthrodesis Plate 2.7mm/3.5mm  
**I52925** Partial Tarsal Arthrodesis Plate 2.7mm/3.5mm

## Medial Pantarsal Arthrodesis Plates



Please note that the left & right description for the pantarsal plates applies when the plate is applied medially.

### 2.0/2.7mm Medial Pantarsal Arthrodesis Plates

**I52918** 2.0mm/2.7mm Pantarsal Plate Right Cat 120°  
**I52917** 2.0mm/2.7mm Pantarsal Plate Left Cat 120°  
**I52916** 2.0mm/2.7mm Pantarsal Plate Right Dog 140°  
**I52915** 2.0mm/2.7mm Pantarsal Plate Left Dog 140°

### 2.7/3.5mm Medial Pantarsal Arthrodesis Plates

**I52914** 2.7mm/3.5mm Pantarsal Plate Right Short  
**I52913** 2.7mm/3.5mm Pantarsal Plate Left Short

## Feline Pantarsal Plate With T4 Slot



### 1.5/2.0mm Feline Pantarsal Plate With T4 Slot

**I52967-T4** 1.5mm/2.0mm Feline Pantarsal Plate with T4 Slot - 120° Right  
**I52966-T4** 1.5mm/2.0mm Feline Pantarsal Plate with T4 Slot - 120° Left

### 2.0/2.7mm Feline Pantarsal Plate With T4 Slot

**I52918-T4** 2.0mm/2.7mm Feline Pantarsal Plate with T4 Slot - 120° Right  
**I52917-T4** 2.0mm/2.7mm Feline Pantarsal Plate with T4 Slot - 120° Left

For scaled plate profiles, please view the Plate Profile chapter.

## Canine Pantarsal Arthrodesis Plates With T4 Slot



### 1.5/2.0mm Canine Pantarsal Arthrodesis Plates With T4 Slot

**I52969-T4** 1.5mm/2.0mm Canine Pantarsal Plate With T4 Slot - 135° Right  
**I52968-T4** 1.5mm/2.0mm Canine Pantarsal Plate With T4 Slot - 135° Left

### 2.0/2.7mm Canine Pantarsal Arthrodesis Plates With T4 Slot

**I52916-T4** 2.0mm/2.7mm Canine (Small) Pantarsal Plate With T4 Slot - 140° Right  
**I52915-T4** 2.0mm/2.7mm Canine (Small) Pantarsal Plate With T4 Slot - 140° Left  
**I52964-T4** 2.0mm/2.7mm Canine Pantarsal Plate With T4 slot – 140° Left  
**I52965-T4** 2.0mm/2.7mm Canine Pantarsal Plate With T4 slot – 140° Right

### 2.0/2.7/3.5mm Canine Pantarsal Arthrodesis Plates With T4 Slot

**I52962-T4** 2.0mm/2.7mm/3.5mm Medial Pantarsal Arthrodesis Plate Left With T4  
**I52963-T4** 2.0mm/2.7mm/3.5mm Medial Pantarsal Arthrodesis Plate Right With T4

### 2.7/3.5mm Canine Pantarsal Arthrodesis Plates With T4 Slot

**I52914-T4S** 2.7mm/3.5mm Canine Pantarsal Plate With T4 Slot - Right Short  
**I52913-T4S** 2.7mm/3.5mm Canine Pantarsal Plate With T4 Slot - Left Short  
**I52914-T4** 2.7mm/3.5mm Canine Pantarsal Plate With T4 Slot - Right Hand  
**I52913-T4** 2.7mm/3.5mm Canine Pantarsal Plate With T4 Slot - Left Hand

### 2.7/3.5mm Canine Pantarsal Arthrodesis Plates With T4 Slot - Titanium

**I52913-T4Ti** 2.7mm/3.5mm Canine Pantarsal Arthrodesis T4 Slot Left Titanium  
**I52914-T4Ti** 2.7mm/3.5mm Canine Pantarsal Arthrodesis T4 Slot Right Titanium

### 2.7/3.5/4.5mm Canine Pantarsal Arthrodesis Plates With T4 Slot

**I52960-T4** 2.7mm/3.5mm/4.5mm Canine Pantarsal Plate With T4 Slot - Left Hand  
**I52961-T4** 2.7mm/3.5mm/4.5mm Canine Pantarsal Plate With T4 Slot - Right Hand

## Combi Canine Pantarsal Plates

The Vi Combi 2.7/3.5mm Canine Pantarsal Arthrodesis Plate has been created as an extension of our current Pantarsal Arthrodesis Plates range. Plate shape and standing angle have been carried over from the existing range due to the positive outcomes in surgery over the past 18 years. However, this plate comes with the added benefit of locking technology.

Developed in partnership with leading Orthopaedic Veterinary Surgeons, the plate has been carefully modelled against real life CT scans. A successful design has been achieved through the angling of the distal dynamic locking holes. This design feature was focussed on ensuring the best possible screw projection for maximum bone capture of the metatarsals in the majority of patients.

#### Key Features & Benefits:

- Locking construct increases stability
- Stacked locking hole allows placement of either a locking or non-locking screw
- Dynamic Locking holes in proximal section
- Angled dynamic locking holes in distal section to allow screw projection through maximum number of metatarsals
- Angled T4 slotted hole with locking hole at the proximal end of the slot
- Distal section tapered to follow shape of metatarsals and reduce bone stress
- Three 1.5mm K-wire holes
- Available in left and right configuration
- Available in Stainless Steel



**I52913-T4COMBI** 2.7/3.5mm Combi Canine Pantarsal Plate Left  
**I52914-T4COMBI** 2.7/3.5mm Combi Canine Pantarsal Plate Right

For scaled plate profiles, please view the Plate Profile chapter.

### Elbow Arthrodesis Plates

Elbow arthrodesis may present a realistic option where funds are limited or where joint replacement has failed. Available in a single size designed for the Labrador-sized patient, & available in both locking & non-locking variants.



- I52950** Elbow Arthrodesis Plate 2.7/3.5mm 130° Right
- I52951** Elbow Arthrodesis Plate 2.7/3.5mm 130° Left
- I52950LOCK** Elbow Arthrodesis Plate 2.7/3.5mm 130° Right - Locking
- I52951LOCK** Elbow Arthrodesis Plate 2.7/3.5mm 130° Left - Locking

### Limb Salvage Plates

A range of plates for certain scenarios where an extended length plate is required for limb salvage.

#### 2.7/3.5mm Canine Forelimb Salvage Plate



**I52903XXL** 2.7mm/3.5mm Canine Limb Salvage Plate 262mm Long

#### Super XXL 3.5/4.5mm Forelimb Salvage Plate



**I52980** Super XXL Forelimb Salvage Plate

#### Feline/Small Canine Forelimb Salvage Plate



**I52910** Forelimb Salvage Plate 1.5/2.0mm

### Hindlimb Salvage Plates



#### Feline Hindlimb Salvage Plates

- I52917-T4XL** Feline (120°) Hindlimb Salvage Plate 2.0mm/2.7mm Left
- I52918-T4XL** Feline (120°) Hindlimb Salvage Plate 2.0mm/2.7mm Right

#### Canine Hindlimb Salvage Plates

- I52913-T4XL** Canine (140°) Hindlimb Salvage Plate 2.7mm/3.5mm Left
- I52914-T4XL** Canine (140°) Hindlimb Salvage Plate 2.7mm/3.5mm Right

For scaled plate profiles, please view the Plate Profile chapter.

## LeiLOX 1.5/2.0 MicroLocking System

### 1.5/2.0 Osteosynthesis Locking Set Titanium



Contains:

- 1x Tray for Implants & Instruments with Lid
- 1x Locking Plate of each style (28 pcs. total)
- 5x of each 1.5 Locking Screw (5-24mm, 70 pcs. total)
- 5x of each 2.0 Locking Screw (5-30mm, 85 pcs. total)
- 2x Screwdriver Shafts
- 1x Screwdriver Handle
- 2x 2 Locking Drill Guides
- 1x Depth Gauge
- 2x Drills (AO, 1.1 & 1.5)
- 1x pair of Bending Irons

**LEILOX142-1520-00** LeiLOX Titanium 1.5/2mm Micro Fracture Locking Plate Kit

### 1.5 Locking Plate Titanium



5mm wide, 1.5mm thick

- LEILOX142-0215-04** LeiLOX Titanium 1.5mm Locking Plate 4 Hole 25.5mm
- LEILOX142-0215-05** LeiLOX Titanium 1.5mm Locking Plate 5 Hole 32.5mm
- LEILOX142-0215-06** LeiLOX Titanium 1.5mm Locking Plate 6 Hole 39.5mm
- LEILOX142-0215-07** LeiLOX Titanium 1.5mm Locking Plate 7 Hole 46.5mm
- LEILOX142-0215-08** LeiLOX Titanium 1.5mm Locking Plate 8 Hole 53.5mm
- LEILOX142-0215-09** LeiLOX Titanium 1.5mm Locking Plate 9 Hole 60.5mm
- LEILOX142-0215-10** LeiLOX Titanium 1.5mm Locking Plate 10 Hole 67.5mm

### 1.5 Locking Y-Plate Titanium



5mm/11mm wide, 1.5mm thick

**LEILOX142-0215-805** LeiLOX Titanium 1.5mm Y-Locking Plate 5 Hole 33mm Long

## LeiLOX 1.5mm Locking Screws Titanium



For LeiLOX Locking System. Self-tapping. Requires Star Drive T6 insert

- LEILOX245-415-05** LeiLOX Titanium 1.5mm Locking Screw 5mm
- LEILOX245-415-06** LeiLOX Titanium 1.5mm Locking Screw 6mm
- LEILOX245-415-07** LeiLOX Titanium 1.5mm Locking Screw 7mm
- LEILOX245-415-08** LeiLOX Titanium 1.5mm Locking Screw 8mm
- LEILOX245-415-09** LeiLOX Titanium 1.5mm Locking Screw 9mm
- LEILOX245-415-10** LeiLOX Titanium 1.5mm Locking Screw 10mm
- LEILOX245-415-11** LeiLOX Titanium 1.5mm Locking Screw 11mm
- LEILOX245-415-12** LeiLOX Titanium 1.5mm Locking Screw 12mm
- LEILOX245-415-14** LeiLOX Titanium 1.5mm Locking Screw 14mm
- LEILOX245-415-16** LeiLOX Titanium 1.5mm Locking Screw 16mm
- LEILOX245-415-18** LeiLOX Titanium 1.5mm Locking Screw 18mm
- LEILOX245-415-20** LeiLOX Titanium 1.5mm Locking Screw 20mm
- LEILOX245-415-22** LeiLOX Titanium 1.5mm Locking Screw 22mm
- LEILOX245-415-24** LeiLOX Titanium 1.5mm Locking Screw 24mm
- LEILOX245-415-26** LeiLOX Titanium 1.5mm Locking Screw 26mm

**LEILOX128-1520-15** LeiLOX Screwdriver Shaft Star Drive T6 For 1.5mm Screws

## 2.0 Locking Plate Titanium



6mm wide, 1.5mm thick

- LEILOX142-0220-06** LeiLOX Titanium 2mm Locking Plate 6 Hole 51mm
- LEILOX142-0220-07** LeiLOX Titanium 2mm Locking Plate 7 Hole 60mm
- LEILOX142-0220-08** LeiLOX Titanium 2mm Locking Plate 8 Hole 69mm
- LEILOX142-0220-09** LeiLOX Titanium 2mm Locking Plate 9 Hole 78mm
- LEILOX142-0220-10** LeiLOX Titanium 2mm Locking Plate 10 Hole 87mm

### 2.0 Locking Y-Plate Titanium



6mm/13.5mm wide, 1.5mm thick

- LEILOX142-0220-805 LeiLOX Titanium 2mm Y-Locking Plate 5 Hole 42mm
- LEILOX142-0220-809 LeiLOX Titanium 2mm Y-Locking Plate 10 Hole Cuttable

### LeiLOX 2.0mm Locking Screws Titanium



For LeiLOX Locking System. Self-tapping. Requires Star Drive T8 insert

- LEILOX245-420-05 LeiLOX Titanium 2mm Locking Screw 5mm
- LEILOX245-420-06 LeiLOX Titanium 2mm Locking Screw 6mm
- LEILOX245-420-07 LeiLOX Titanium 2mm Locking Screw 7mm
- LEILOX245-420-08 LeiLOX Titanium 2mm Locking Screw 8mm
- LEILOX245-420-09 LeiLOX Titanium 2mm Locking Screw 9mm
- LEILOX245-420-10 LeiLOX Titanium 2mm Locking Screw 10mm
- LEILOX245-420-11 LeiLOX Titanium 2mm Locking Screw 11mm
- LEILOX245-420-12 LeiLOX Titanium 2mm Locking Screw 12mm
- LEILOX245-420-14 LeiLOX Titanium 2mm Locking Screw 14mm
- LEILOX245-420-16 LeiLOX Titanium 2mm Locking Screw 16mm
- LEILOX245-420-18 LeiLOX Titanium 2mm Locking Screw 18mm
- LEILOX245-420-20 LeiLOX Titanium 2mm Locking Screw 20mm
- LEILOX245-420-22 LeiLOX Titanium 2mm Locking Screw 22mm
- LEILOX245-420-24 LeiLOX Titanium 2mm Locking Screw 24mm
- LEILOX245-420-26 LeiLOX Titanium 2mm Locking Screw 26mm
- LEILOX245-420-28 LeiLOX Titanium 2mm Locking Screw 28mm
- LEILOX245-420-30 LeiLOX Titanium 2mm Locking Screw 30mm
  
- LEILOX128-1520-20 LeiLOX Screwdriver Shaft Star Drive T8 For 2/2.4mm Screws

### LeiLOX Instrumentation

#### Screwdriver Handle



Silicone AO-Connection. Sterilizable upto 134°C

- TTAR247010300 AO Fit Screwdriver Handle

#### Screwdriver Shaft Star-Drive



AO-Connection, self-holding

- LEILOX128-1520-15 Screwdriver Shaft Star Drive T6 For 1.5mm Screws
- LEILOX128-1520-20 Screwdriver Shaft Star Drive T8 For 2/2.4mm Screws

#### Locking Drill Guide



20mm long

- LEILOX164-0015-00 Locking Drill Guide F/1.5mm Screws 1.1mm Drill
- LEILOX164-0020-00 Locking Drill Guide F/2mm Screws 1.5mm Drill

#### Depth Gauge



Scale up to 40mm, for 1.5/2.0mm screws

- LEILOX164-1520-20 Depth Gauge For 1.5/2mm Screws

#### Bone Plate Holding Forceps



125mm long, 45mm working end

- LEILOX128-0538-13 Plate Holding Forceps 45mm Angled Tips 125mm Long



## Shaft Screws

### 4.5mm Shaft Screws for HIF



We offer a range of 4.5mm shaft screws specifically designed to be used as trans-condylar stabilising screws. Note that the 4.5mm shaft screws are significantly stronger than a standard 4.5mm cortical screw.

<b>SHSC4532</b>	Shaft Screw	32mm	
<b>SHSC4534</b>	Shaft Screw	34mm	
<b>SHSC4536</b>	Shaft Screw	36mm	
<b>SHSC4538</b>	Shaft Screw	38mm	
<b>SHSC4540</b>	Shaft Screw	40mm	
<b>SHSC4542</b>	Shaft Screw	42mm	
<b>SHSC4544</b>	Shaft Screw	44mm	
<b>SHSC4534TI</b>	Shaft Screw	34mm	Titanium
<b>SHSC4536TI</b>	Shaft Screw	36mm	Titanium

Please note that a tap is required for the shaft screws. It is also recommended that an insert sleeve is used to centre the pilot hole in the far condyle.

<b>COU4565QR</b>	Quick Release Countersink For 4.5mm/6.5mm Screws AO Fit
<b>COU4565T-A</b>	T Bar Countersink For 4.5mm/6.5mm Screws
<b>DRILLSTOP</b>	Drill Stop Set In Stainless Case
<b>SDH4500</b>	Hex Screwdriver For 4.5mm/5.5mm/6.5mm Screws
<b>H090105S</b>	3.2mm (Pilot) Drill Round Shank
<b>S090105S</b>	3.2mm (Pilot) Drill AO Quick Release
<b>H090108S</b>	4.5mm (Clearance) Drill Round Shank
<b>S090108S</b>	4.5mm (Clearance) Drill AO Quick Release
<b>TS00045</b>	4.5mm Cortical Tap Quick Release - Handle Required
<b>ADJ45</b>	Adjustable Drill Guide for 4.5mm Drills
<b>SL4532</b>	Insert Sleeve 4.5x3.2mm

## Cortical Nuts

<b>N45</b>	4.5mm Cortical Nut Stainless Steel Non Sterile
<b>CN45-A</b>	4.5mm Cortical Nut UHMPWE - Sterile

## Condyle Clamp



**001080** Condyle Clamp Stainless Steel

## Titanium Mesh System



Based on a human product, our Titanium Mesh is cuttable & is mouldable in three-dimensions, making it very adaptable & ideal for cranial fractures & in the management of fractures of other flat bones that are not load bearing.

The mesh has also been used to augment bone cement in joint replacement surgery.

The screws are tapered, making them self-drilling & self-tapping, however, a drill of 1mm diameter or less may be used to start the screws & may help reduce the chances of cracks forming if used close to the fracture lines.

The screws are made of titanium to avoid any problems arising from mixed metallurgy & feature a low profile cruciate head designed for use with the cruciate screwdriver with AO quick release fitting.

A 5mm or 7mm length appears to be the most useful for our species.

<b>TIMESH405006</b>	Titanium Mesh 40mm x 50mm 0.6mm Thick
<b>TIMESH506006</b>	Titanium Mesh 50mm x 60mm 0.6mm Thick
<b>TIMESH607006</b>	Titanium Mesh 60mm x 70mm 0.6mm Thick
<b>TIMESHSCREW2005</b>	Titanium Mesh Screws Tapered 2.0mm x 5.0mm Length Cruciate Head
<b>TIMESHSCREW2007</b>	Titanium Mesh Screws Tapered 2.0mm x 7.0mm Length Cruciate Head
<b>TIMESHSDI</b>	Screwdriver Insert for 2mm Cruciate Titanium Mesh Screws. AO Quick Release



<b>TIMESHCUT</b>	Titanium Mesh Cutters
<b>TIMESHPLI</b>	Titanium Mesh Contouring Pliers

### Screw Identification Tree

Use this decision tree tool to help you identify different type of screw. Start on the left & work your way across.

The code prefixes relate to the type of screw e.g. CSST = cortical screw self tapping, LS = locking screw, CAN = cancellous & so on.

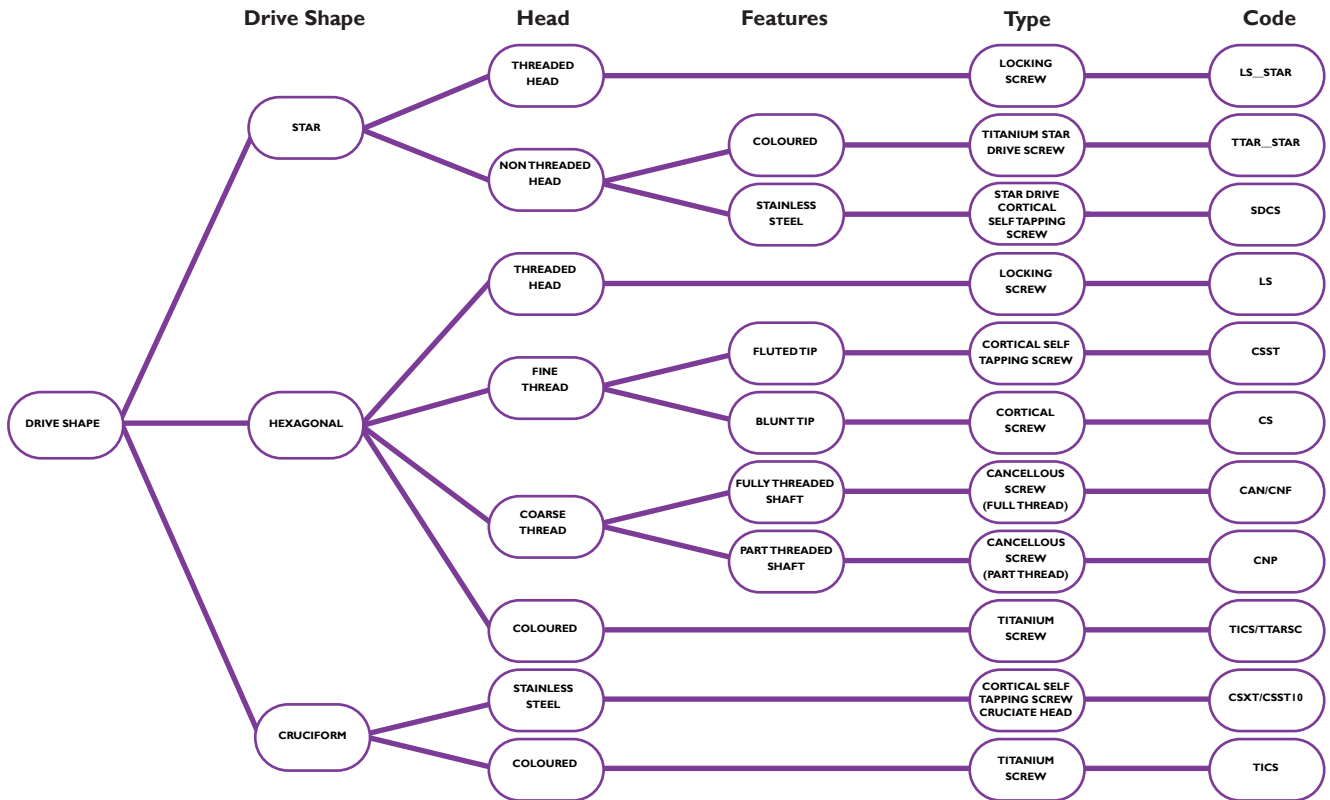

### Screw Identification - Type & Size Chart

Once you have used the decision tree to help you identify type, next measure the screw (length & width).

Use this chart to help confirm your identification - where there is a dot in the chart, the corresponding size/type exists.

	1.0mm	1.5mm	2.0mm	2.2mm	2.4mm	2.7mm	3.0mm	3.5mm	4.0mm	4.5mm	5.5mm	6.5mm
CS		●	●			●		●		●	●	
CSST	●	●	●		●	●		●		●		
CSXT		●	●		●	●						
SDCS		●	●		●	●						
LS								●				
LS-STAR		●	●		●	●		●				
TICS					●	●		●		●		
TTARSC			●		●							
TTAR-STAR		●	●									
CAN				●			●	●				
CNF									●			●
CNP									●			

## Vi Screw Types, Drive Shape, Sizes & Ordering Codes For Cortical & Cortical Self Tapping Screws

Once you have used the decision tree & the type/size chart, then refer to this table to confirm your identification & find out the product code (the last two digits of a code, indicated by \*\*, refer to the length of the screw).

Screw Type	Drive Shape	Diameter	Vi Ordering Code
Cortical Non Self Tapping	Hexagonal	1.5mm	CS15**
		2.0mm	CS20**
		2.7mm	CS27**
		3.5mm	CS35**
		4.5mm	CS45**
Cortical Self Tapping	Hexagonal	1.5mm	CSST15**
		2.0mm	CSST20**
		2.4mm	CSST24**
		2.7mm	CSST27**
		3.5mm	CSST35**
Cortical Self Tapping	Star Drive	1.5mm	SDCS15**
		2.0mm	SDCS20**
		2.4mm	SDCS24**
		2.7mm	SDCS27**
		3.5mm	SDCS35**
Cortical Self Tapping	Cruciform	1.0mm	CSST10** for 1.0mm
		1.5mm	CSXT15**
		2.0mm	CSXT20**
		2.4mm	CSXT24**

## Screwdriver Decision Tree For Cortical, Cortical Self-Tapping & Cancellous Screws Identification Tree

Once you have identified the type & size of screw, use this decision tree to determine the correct screwdriver.

Where there are 2 options in the far right column, this is a fixed shaft screwdriver OR a quick release handle + separate screwdriver shaft (there may be 2 possible codes for the quick release handle).

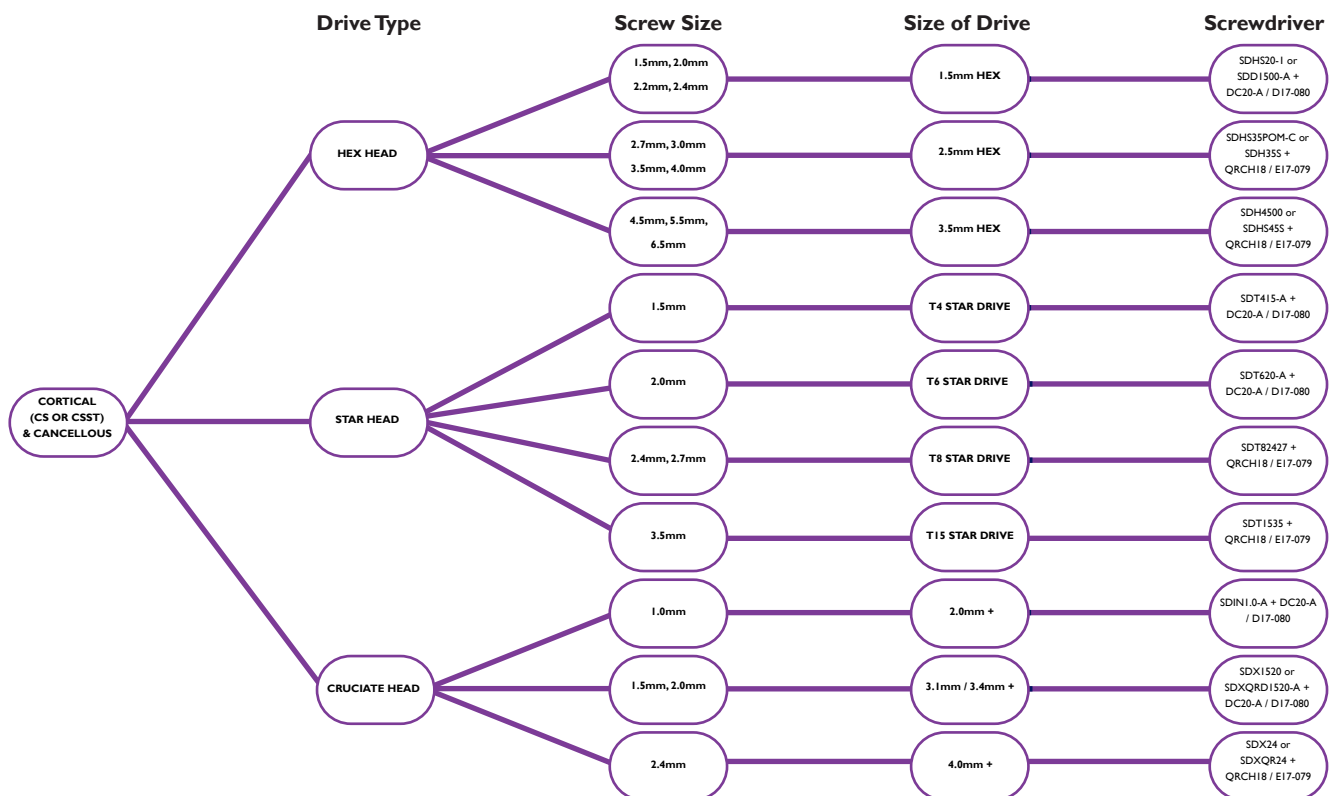

### Screwdriver Decision Tree For Locking Screws

Once you have identified the type & size of screw, use this decision tree to determine the correct screwdriver.

Where there are 2 options in the far right column, this is a fixed shaft screwdriver OR a quick release handle + separate screwdriver shaft (there may be 2 possible codes for the quick release handle).

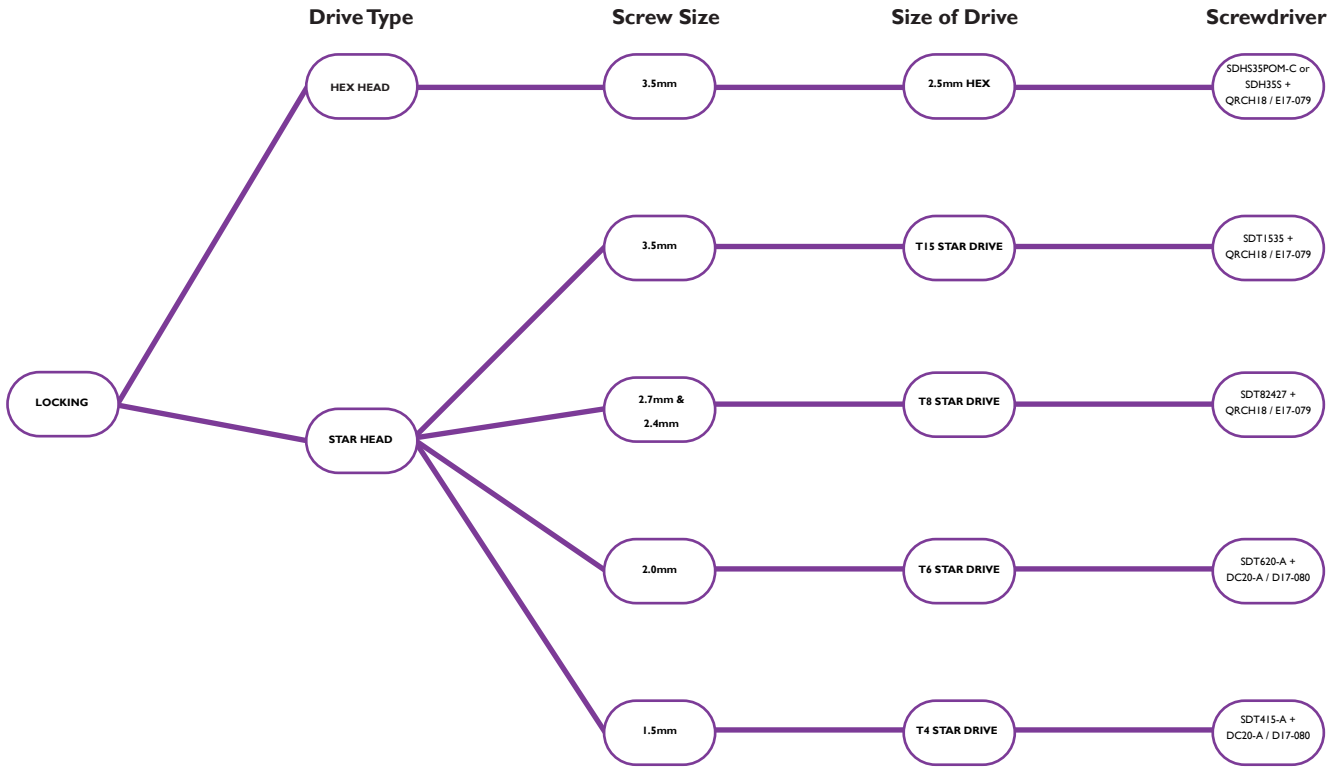

### Screwdriver Decision Tree For Titanium Screws

Once you have identified the type & size of screw, use this decision tree to determine the correct screwdriver.

Where there are 2 options in the far right column, this is a fixed shaft screwdriver OR a quick release handle + separate screwdriver shaft (there may be 2 possible codes for the quick release handle).

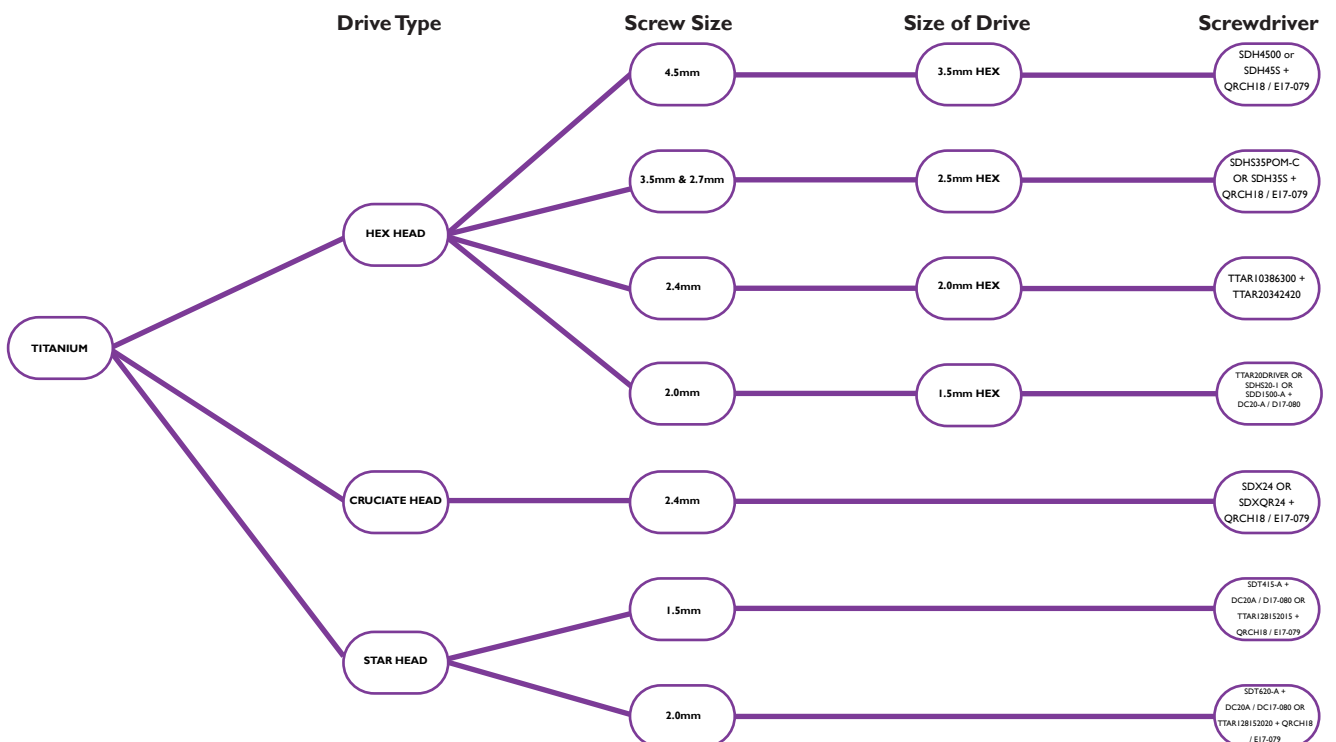

## Pilot and Clearance Drill Data For Locking Screws

	Locking Star Drive (1.5mm)	Locking Star Drive (2.0mm)	Locking Star Drive (2.4mm)	Locking Star Drive (2.7mm)	Locking Star Drive (3.5mm)	Locking Hex Head (3.5mm)
Pilot Drill	1.1mm	1.5mm	1.8mm	2.0mm	2.8mm	2.8mm
Round Shank	H090100	H090101	H090208	H090102	H090103	H090103
AO Quick Fit	S090100S	S090101S	S090208	S090102S	S090103S	S090103S
Tap - Modular	TSL515-A (Dental Fit)	TSL520-A (Dental Fit)	TSL524	TSL527	TSL535	TSL535

## Pilot and Clearance Drill Data for Cortical Self Tapping Screws

	Cortical Self Tapping (1.0mm)	Cortical Self Tapping (1.5mm)	Cortical Self Tapping (2.0mm)	Cortical Self Tapping (2.4mm)	Cortical Self Tapping (2.7mm)	Cortical Self Tapping (3.5mm)	Cortical Self Tapping (4.5mm)
Pilot Drill	0.7mm	1.1mm	1.5mm	1.8mm	2.0mm	2.5mm	3.2mm
Round Shank	N/A	H090100	H090101	H090208	H090102	H090112	H090105S
AO Quick Fit	I0MDB07-A (Dental Fit)	S090100S	S090101S	S090208	S090102SS090102S	S090112S	S090105S
Clearance Drill	1.0mm	1.5mm	2.0mm	2.4mm	2.7mm	3.5mm	4.5mm
Round Shank	N/A	H090101	H090102	H090209	H090104	H090106S	H090108S
AO Quick Fit	I0MDB10-A (Dental Fit)	S090101S	S090102S	S090209	S090104S	S090106S	S090108S

## Pilot Drill, Clearance Drill and Tap Data for Cortical Non Self Tapping Screws

	Cortical Non Self Tapping (1.5mm)	Cortical Non Self Tapping (2.0mm)	Cortical Non Self Tapping (2.7mm)	Cortical Non Self Tapping (3.5mm)	Cortical Non Self Tapping (4.5mm)	Cortical Non Self Tapping (5.5mm)
Pilot Drill	1.1mm	1.5mm	2.0mm	2.5mm	3.2mm	4.0mm
Round Shank	H090100	H090101	H090102	H090112	H090205S	H090107
AO Quick Fit	S0901022S	S090101S	S090102S	S090112S	S090105S	S090107
Clearance Drill	1.5mm	2.0mm	2.7mm	2.5mm	4.5mm	5.5mm
Round Shank	H090101	H090102	H090104	H090106S	H090108S	H090109
AO Quick Fit	S090101S	S090102S	S090104S	S090106S	S090108S	S090109
Tap - Modular	TD50015	TD0020	TS0027	TS12535	TS00045	TS00055
Tap - "T" Bar	TBT015	TBT020	TBT027	TBT12535	N/A	N/A

## Pilot Drill, Clearance Drill and Tap Data for Cancellous Screws

	Small Cancellous (2.2mm)	Small Cancellous (3.0mm)	Small Cancellous (3.5mm)	Cancellous (4.0mm)	Cancellous (6.5mm)
Pilot Drill	1.5mm	2.0mm	2.0mm	2.5mm	3.2mm
Round Shank	H090101	H090102	H090102	H090112	H090105S
AO Quick Fit	S090101S	S090102S	S090102S	S090112S	S090105S
Clearance Drill	2.0mm	3.0mm	3.5mm	4.0mm	6.5mm
Round Shank	H090102	H090205	H090106S	H090107	N/A
AO Quick Fit	S090102S	N/A	S090106S	S090107	N/A
Tap - Modular	N/A	N/A	TS17535	TS17535	TS00065
Tap - "T" Bar	N/A	N/A	TBT17535	TBT17535	TBT065

### Locking Screws 1.5mm Locking Screws Star Drive

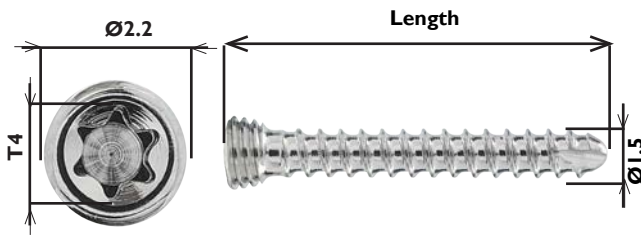

pilot drill - 1.1mm

- LS15STAR06** Locking Star Screw 1.5mm 6mm Long
- LS15STAR07** Locking Star Screw 1.5mm 7mm Long
- LS15STAR08** Locking Star Screw 1.5mm 8mm Long
- LS15STAR09** Locking Star Screw 1.5mm 9mm Long
- LS15STAR10** Locking Star Screw 1.5mm 10mm Long
- LS15STAR11** Locking Star Screw 1.5mm 11mm Long
- LS15STAR12** Locking Star Screw 1.5mm 12mm Long
- LS15STAR14** Locking Star Screw 1.5mm 14mm Long
- LS15STAR16** Locking Star Screw 1.5mm 16mm Long
- LS15STAR18** Locking Star Screw 1.5mm 18mm Long
- LS15STAR20** Locking Star Screw 1.5mm 20mm Long
- LS15STAR22** Locking Star Screw 1.5mm 22mm Long
- LS15STAR24** Locking Star Screw 1.5mm 24mm Long

### 2.0mm Locking Screws Star Drive

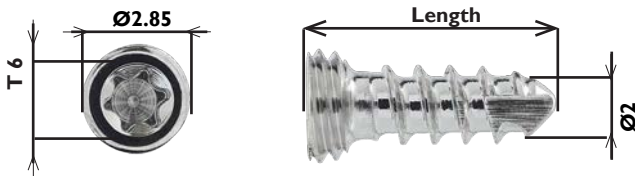

pilot drill - 1.5mm

- LS20STAR06** Locking 2.0mm Screw Star Drive 6mm
- LS20STAR07** Locking 2.0mm Screw Star Drive 7mm
- LS20STAR08** Locking 2.0mm Screw Star Drive 8mm
- LS20STAR10** Locking 2.0mm Screw Star Drive 10mm
- LS20STAR12** Locking 2.0mm Screw Star Drive 12mm
- LS20STAR14** Locking 2.0mm Screw Star Drive 14mm
- LS20STAR16** Locking 2.0mm Screw Star Drive 16mm
- LS20STAR18** Locking 2.0mm Screw Star Drive 18mm
- LS20STAR20** Locking 2.0mm Screw Star Drive 20mm
- LS20STAR22** Locking 2.0mm Screw Star Drive 22mm
- LS20STAR24** Locking 2.0mm Screw Star Drive 24mm
- LS20STAR26** Locking 2.0mm Screw Star Drive 26mm
- LS20STAR28** Locking 2.0mm Screw Star Drive 28mm
- LS20STAR30** Locking 2.0mm Screw Star Drive 30mm

### 2.4mm Locking Screws Star Drive

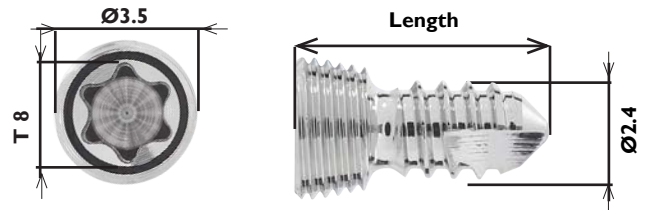

pilot drill - 1.8mm

The 2.4 Locking Screw has the same head dimensions as the 2.7mm Locking Screw (LS2724\*\* series) & may therefore be used in both 2.4mm Locking Plates & 2.7mm Locking Plates.

- LS2424STAR06** Locking 2.4mm Screw Star Drive 6mm
- LS2424STAR08** Locking 2.4mm Screw Star Drive 8mm
- LS2424STAR10** Locking 2.4mm Screw Star Drive 10mm
- LS2424STAR12** Locking 2.4mm Screw Star Drive 12mm
- LS2424STAR14** Locking 2.4mm Screw Star Drive 14mm
- LS2424STAR16** Locking 2.4mm Screw Star Drive 16mm
- LS2424STAR18** Locking 2.4mm Screw Star Drive 18mm
- LS2424STAR20** Locking 2.4mm Screw Star Drive 20mm
- LS2424STAR22** Locking 2.4mm Screw Star Drive 22mm
- LS2424STAR24** Locking 2.4mm Screw Star Drive 24mm
- LS2424STAR26** Locking 2.4mm Screw Star Drive 26mm
- LS2424STAR28** Locking 2.4mm Screw Star Drive 28mm
- LS2424STAR30** Locking 2.4mm Screw Star Drive 30mm
- LS2424STAR32** Locking 2.4mm Screw Star Drive 32mm
- LS2424STAR34** Locking 2.4mm Screw Star Drive 34mm
- LS2424STAR36** Locking 2.4mm Screw Star Drive 36mm
- LS2424STAR38** Locking 2.4mm Screw Star Drive 38mm
- LS2424STAR40** Locking 2.4mm Screw Star Drive 40mm

### 2.7mm Locking Screws Star Drive

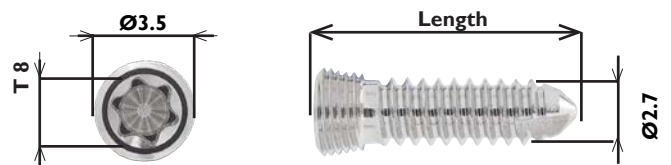

pilot drill - 2.0mm

- LS2724STAR06** Locking 2.7mm Screw (2.4 Head) Star Drive 6mm
- LS2724STAR08** Locking 2.7mm Screw (2.4 Head) Star Drive 8mm
- LS2724STAR10** Locking 2.7mm Screw (2.4 Head) Star Drive 10mm
- LS2724STAR12** Locking 2.7mm Screw (2.4 Head) Star Drive 12mm
- LS2724STAR14** Locking 2.7mm Screw (2.4 Head) Star Drive 14mm
- LS2724STAR16** Locking 2.7mm Screw (2.4 Head) Star Drive 16mm
- LS2724STAR18** Locking 2.7mm Screw (2.4 Head) Star Drive 18mm
- LS2724STAR20** Locking 2.7mm Screw (2.4 Head) Star Drive 20mm
- LS2724STAR22** Locking 2.7mm Screw (2.4 Head) Star Drive 22mm
- LS2724STAR24** Locking 2.7mm Screw (2.4 Head) Star Drive 24mm
- LS2724STAR26** Locking 2.7mm Screw (2.4 Head) Star Drive 26mm
- LS2724STAR28** Locking 2.7mm Screw (2.4 Head) Star Drive 28mm
- LS2724STAR30** Locking 2.7mm Screw (2.4 Head) Star Drive 30mm
- LS2724STAR32** Locking 2.7mm Screw (2.4 Head) Star Drive 32mm
- LS2724STAR34** Locking 2.7mm Screw (2.4 Head) Star Drive 34mm
- LS2724STAR36** Locking 2.7mm Screw (2.4 Head) Star Drive 36mm
- LS2724STAR38** Locking 2.7mm Screw (2.4 Head) Star Drive 38mm
- LS2724STAR40** Locking 2.7mm Screw (2.4 Head) Star Drive 40mm

### 3.5mm Locking Screws Star Drive

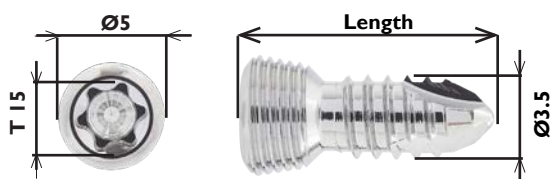

pilot drill - 2.8mm

- LS35STAR10** Locking 3.5mm Screw Star Drive 10mm
- LS35STAR12** Locking 3.5mm Screw Star Drive 12mm
- LS35STAR14** Locking 3.5mm Screw Star Drive 14mm
- LS35STAR16** Locking 3.5mm Screw Star Drive 16mm
- LS35STAR18** Locking 3.5mm Screw Star Drive 18mm
- LS35STAR20** Locking 3.5mm Screw Star Drive 20mm
- LS35STAR22** Locking 3.5mm Screw Star Drive 22mm
- LS35STAR24** Locking 3.5mm Screw Star Drive 24mm
- LS35STAR26** Locking 3.5mm Screw Star Drive 26mm
- LS35STAR28** Locking 3.5mm Screw Star Drive 28mm
- LS35STAR30** Locking 3.5mm Screw Star Drive 30mm
- LS35STAR32** Locking 3.5mm Screw Star Drive 32mm
- LS35STAR34** Locking 3.5mm Screw Star Drive 34mm
- LS35STAR36** Locking 3.5mm Screw Star Drive 36mm
- LS35STAR38** Locking 3.5mm Screw Star Drive 38mm
- LS35STAR40** Locking 3.5mm Screw Star Drive 40mm
- LS35STAR42** Locking 3.5mm Screw Star Drive 42mm
- LS35STAR44** Locking 3.5mm Screw Star Drive 44mm
- LS35STAR45** Locking 3.5mm Screw Star Drive 45mm
- LS35STAR46** Locking 3.5mm Screw Star Drive 46mm
- LS35STAR48** Locking 3.5mm Screw Star Drive 48mm
- LS35STAR50** Locking 3.5mm Screw Star Drive 50mm
- LS35STAR52** Locking 3.5mm Screw Star Drive 52mm
- LS35STAR54** Locking 3.5mm Screw Star Drive 54mm
- LS35STAR56** Locking 3.5mm Screw Star Drive 56mm
- LS35STAR58** Locking 3.5mm Screw Star Drive 58mm
- LS35STAR60** Locking 3.5mm Screw Star Drive 60mm

### Locking Plugs



Use to protect locking holes during contouring.

- LSP15STAR** Locking Plug For LS15STAR\*\* Screws
- LSP20STAR** Locking Plug For LS20STAR\*\* Screws
- LSP24STAR** Locking Plug For LS2724STAR\*\* & LS2424STAR\*\* Screws
- LSP35STAR** Locking Plug For LS35STAR\*\* Screws
- LSP35** Locking Plug For LS35\*\* Hex Drive Screws

### 3.5mm Locking Screws Hex Drive

pilot drill - 2.8mm

- LS3510** Locking 3.5mm Screw Hex Drive 10mm
- LS3512** Locking 3.5mm Screw Hex Drive 12mm
- LS3514** Locking 3.5mm Screw Hex Drive 14mm
- LS3516** Locking 3.5mm Screw Hex Drive 16mm
- LS3518** Locking 3.5mm Screw Hex Drive 18mm
- LS3520** Locking 3.5mm Screw Hex Drive 20mm
- LS3522** Locking 3.5mm Screw Hex Drive 22mm
- LS3524** Locking 3.5mm Screw Hex Drive 24mm
- LS3526** Locking 3.5mm Screw Hex Drive 26mm
- LS3528** Locking 3.5mm Screw Hex Drive 28mm
- LS3530** Locking 3.5mm Screw Hex Drive 30mm
- LS3532** Locking 3.5mm Screw Hex Drive 32mm
- LS3534** Locking 3.5mm Screw Hex Drive 34mm
- LS3536** Locking 3.5mm Screw Hex Drive 36mm
- LS3538** Locking 3.5mm Screw Hex Drive 38mm
- LS3540** Locking 3.5mm Screw Hex Drive 40mm
- LS3542** Locking 3.5mm Screw Hex Drive 42mm
- LS3544** Locking 3.5mm Screw Hex Drive 44mm
- LS3545** Locking 3.5mm Screw Hex Drive 45mm
- LS3546** Locking 3.5mm Screw Hex Drive 46mm
- LS3548** Locking 3.5mm Screw Hex Drive 48mm
- LS3550** Locking 3.5mm Screw Hex Drive 50mm
- LS3552** Locking 3.5mm Screw Hex Drive 52mm
- LS3554** Locking 3.5mm Screw Hex Drive 54mm
- LS3555** Locking 3.5mm Screw Hex Drive 55mm
- LS3556** Locking 3.5mm Screw Hex Drive 56mm
- LS3558** Locking 3.5mm Screw Hex Drive 58mm
- LS3560** Locking 3.5mm Screw Hex Drive 60mm

### Locking Screw Sets



Star Drive Locking Screw Sets in Modular Plating Box Screw Caddy.

- LS15STARKITMPB** 1.5 Star Drive Locking Screw Set
- LS20STARKITMPB** 2.0 Star Drive Locking Screw Set
- LS24STARKITMPB** 2.4 Star Drive Locking Screw Set
- LS27STARKITMPB** 2.7 Star Drive Locking Screw Set
- LS35STARKITMPB** 3.5 Star Drive Locking Screw Set

### 1.5mm Screws

#### 1.5mm Cortical Self Tapping Screws

##### Star Drive

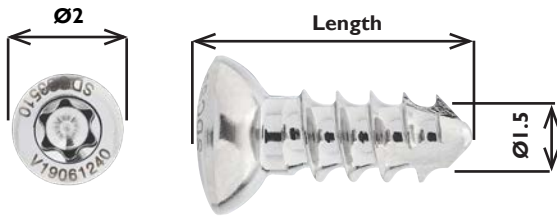

pilot drill - 1.1mm

- SDCSI506** 1.5mm Cortical Self Tapping Screw 6mm Star Drive
- SDCSI507** 1.5mm Cortical Self Tapping Screw 7mm Star Drive
- SDCSI508** 1.5mm Cortical Self Tapping Screw 8mm Star Drive
- SDCSI509** 1.5mm Cortical Self Tapping Screw 9mm Star Drive
- SDCSI510** 1.5mm Cortical Self Tapping Screw 10mm Star Drive
- SDCSI511** 1.5mm Cortical Self Tapping Screw 11mm Star Drive
- SDCSI512** 1.5mm Cortical Self Tapping Screw 12mm Star Drive
- SDCSI514** 1.5mm Cortical Self Tapping Screw 14mm Star Drive
- SDCSI516** 1.5mm Cortical Self Tapping Screw 16mm Star Drive
- SDCSI518** 1.5mm Cortical Self Tapping Screw 18mm Star Drive
- SDCSI520** 1.5mm Cortical Self Tapping Screw 20mm Star Drive
- SDCSI522** 1.5mm Cortical Self Tapping Screw 22mm Star Drive
- SDCSI524** 1.5mm Cortical Self Tapping Screw 24mm Star Drive

#### 1.5mm Cortical Self Tapping Screws

##### Hex Drive



pilot drill - 1.1mm

- CSST1506** 1.5mm Cortical Self Tapping Screw 6mm
- CSST1507** 1.5mm Cortical Self Tapping Screw 7mm
- CSST1508** 1.5mm Cortical Self Tapping Screw 8mm
- CSST1509** 1.5mm Cortical Self Tapping Screw 9mm
- CSST1510** 1.5mm Cortical Self Tapping Screw 10mm
- CSST1511** 1.5mm Cortical Self Tapping Screw 11mm
- CSST1512** 1.5mm Cortical Self Tapping Screw 12mm
- CSST1514** 1.5mm Cortical Self Tapping Screw 14mm
- CSST1516** 1.5mm Cortical Self Tapping Screw 16mm
- CSST1518** 1.5mm Cortical Self Tapping Screw 18mm
- CSST1520** 1.5mm Cortical Self Tapping Screw 20mm
- CSST1522** 1.5mm Cortical Self Tapping Screw 22mm
- CSST1524** 1.5mm Cortical Self Tapping Screw 24mm

#### 1.5mm Cortical Self Tapping Screws

##### Cruciate Drive

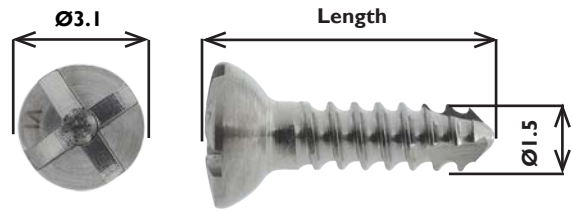

pilot drill - 1.1mm

- CSXT1506** 1.5mm Cortical Self Tapping Screw 6mm Cruciate Head
- CSXT1507** 1.5mm Cortical Self Tapping Screw 7mm Cruciate Head
- CSXT1508** 1.5mm Cortical Self Tapping Screw 8mm Cruciate Head
- CSXT1509** 1.5mm Cortical Self Tapping Screw 9mm Cruciate Head
- CSXT1510** 1.5mm Cortical Self Tapping Screw 10mm Cruciate Head
- CSXT1511** 1.5mm Cortical Self Tapping Screw 11mm Cruciate Head
- CSXT1512** 1.5mm Cortical Self Tapping Screw 12mm Cruciate Head
- CSXT1514** 1.5mm Cortical Self Tapping Screw 14mm Cruciate Head
- CSXT1516** 1.5mm Cortical Self Tapping Screw 16mm Cruciate Head
- CSXT1518** 1.5mm Cortical Self Tapping Screw 18mm Cruciate Head
- CSXT1520** 1.5mm Cortical Self Tapping Screw 20mm Cruciate Head
- CSXT1522** 1.5mm Cortical Self Tapping Screw 22mm Cruciate Head
- CSXT1524** 1.5mm Cortical Self Tapping Screw 24mm Cruciate Head

#### 1.5mm Cortical Screws

##### Hex Drive

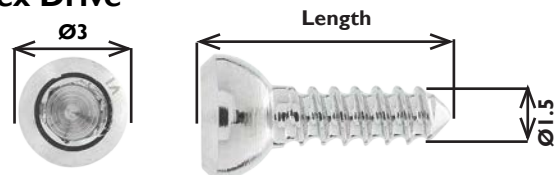

pilot drill - 1.1mm

- CSI506** 1.5mm Cortical Screw 6mm
- CSI507** 1.5mm Cortical Screw 7mm
- CSI508** 1.5mm Cortical Screw 8mm
- CSI509** 1.5mm Cortical Screw 9mm
- CSI510** 1.5mm Cortical Screw 10mm
- CSI511** 1.5mm Cortical Screw 11mm
- CSI512** 1.5mm Cortical Screw 12mm
- CSI514** 1.5mm Cortical Screw 14mm
- CSI516** 1.5mm Cortical Screw 16mm
- CSI518** 1.5mm Cortical Screw 18mm
- CSI520** 1.5mm Cortical Screw 20mm
- CSI522** 1.5mm Cortical Screw 22mm
- CSI524** 1.5mm Cortical Screw 24mm
- CSI526** 1.5mm Cortical Screw 26mm
- CSI528** 1.5mm Cortical Screw 28mm
- CSI530** 1.5mm Cortical Screw 30mm
- CSI532** 1.5mm Cortical Screw 32mm
- CSI534** 1.5mm Cortical Screw 34mm



## 2.0mm Screws

### 2.0mm Cortical Self Tapping Screws Star Drive

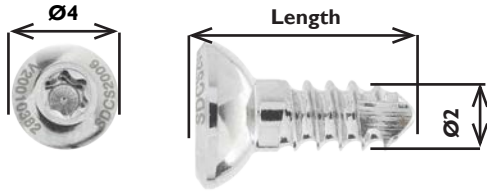

pilot drill - 1.5mm

<b>SDCS2006</b>	Cortical Screw Star Drive 2.0mm Length 06mm Self-Tap
<b>SDCS2007</b>	Cortical Screw Star Drive 2.0mm Length 07mm Self-Tap
<b>SDCS2008</b>	Cortical Screw Star Drive 2.0mm Length 08mm Self-Tap
<b>SDCS2009</b>	Cortical Screw Star Drive 2.0mm Length 09mm Self-Tap
<b>SDCS2010</b>	Cortical Screw Star Drive 2.0mm Length 10mm Self-Tap
<b>SDCS2011</b>	Cortical Screw Star Drive 2.0mm Length 11mm Self-Tap
<b>SDCS2012</b>	Cortical Screw Star Drive 2.0mm Length 12mm Self-Tap
<b>SDCS2014</b>	Cortical Screw Star Drive 2.0mm Length 14mm Self-Tap
<b>SDCS2016</b>	Cortical Screw Star Drive 2.0mm Length 16mm Self-Tap
<b>SDCS2018</b>	Cortical Screw Star Drive 2.0mm Length 18mm Self-Tap
<b>SDCS2020</b>	Cortical Screw Star Drive 2.0mm Length 20mm Self-Tap
<b>SDCS2022</b>	Cortical Screw Star Drive 2.0mm Length 22mm Self-Tap
<b>SDCS2024</b>	Cortical Screw Star Drive 2.0mm Length 24mm Self-Tap
<b>SDCS2026</b>	Cortical Screw Star Drive 2.0mm Length 26mm Self-Tap
<b>SDCS2028</b>	Cortical Screw Star Drive 2.0mm Length 28mm Self-Tap
<b>SDCS2030</b>	Cortical Screw Star Drive 2.0mm Length 30mm Self-Tap
<b>SDCS2032</b>	Cortical Screw Star Drive 2.0mm Length 32mm Self-Tap
<b>SDCS2034</b>	Cortical Screw Star Drive 2.0mm Length 34mm Self-Tap
<b>SDCS2036</b>	Cortical Screw Star Drive 2.0mm Length 36mm Self-Tap
<b>SDCS2038</b>	Cortical Screw Star Drive 2.0mm Length 38mm Self-Tap
<b>SDCS2040</b>	Cortical Screw Star Drive 2.0mm Length 40mm Self-Tap

### 2.0mm Cortical Self Tapping Screws Hex Drive

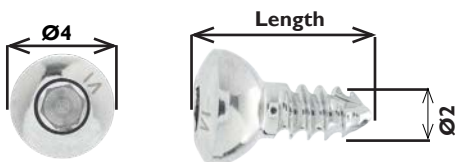

pilot drill - 1.5mm

<b>CSST2006</b>	2mm Cortical Self Tapping Screw 6mm
<b>CSST2007</b>	2mm Cortical Self Tapping Screw 7mm
<b>CSST2008</b>	2mm Cortical Self Tapping Screw 8mm
<b>CSST2009</b>	2mm Cortical Self Tapping Screw 9mm
<b>CSST2010</b>	2mm Cortical Self Tapping Screw 10mm
<b>CSST2011</b>	2mm Cortical Self Tapping Screw 11mm
<b>CSST2012</b>	2mm Cortical Self Tapping Screw 12mm
<b>CSST2014</b>	2mm Cortical Self Tapping Screw 14mm
<b>CSST2016</b>	2mm Cortical Self Tapping Screw 16mm
<b>CSST2018</b>	2mm Cortical Self Tapping Screw 18mm
<b>CSST2020</b>	2mm Cortical Self Tapping Screw 20mm
<b>CSST2022</b>	2mm Cortical Self Tapping Screw 22mm
<b>CSST2024</b>	2mm Cortical Self Tapping Screw 24mm
<b>CSST2026</b>	2mm Cortical Self Tapping Screw 26mm
<b>CSST2028</b>	2mm Cortical Self Tapping Screw 28mm
<b>CSST2030</b>	2mm Cortical Self Tapping Screw 30mm
<b>CSST2032</b>	2mm Cortical Self Tapping Screw 32mm
<b>CSST2034</b>	2mm Cortical Self Tapping Screw 34mm
<b>CSST2036</b>	2mm Cortical Self Tapping Screw 36mm
<b>CSST2038</b>	2mm Cortical Self Tapping Screw 38mm
<b>CSST2040</b>	2mm Cortical Self Tapping Screw 40mm

### 2.0mm Cortical Self Tapping Screws Cruciate Drive

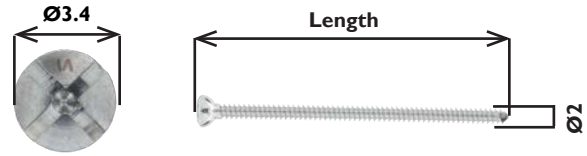

pilot drill - 1.5mm

<b>CSXT2006</b>	2mm Cortical Self Tapping Screw 6mm Cruciate Head
<b>CSXT2007</b>	2mm Cortical Self Tapping Screw 7mm Cruciate Head
<b>CSXT2008</b>	2mm Cortical Self Tapping Screw 8mm Cruciate Head
<b>CSXT2009</b>	2mm Cortical Self Tapping Screw 9mm Cruciate Head
<b>CSXT2010</b>	2mm Cortical Self Tapping Screw 10mm Cruciate Head
<b>CSXT2011</b>	2mm Cortical Self Tapping Screw 11mm Cruciate Head
<b>CSXT2012</b>	2mm Cortical Self Tapping Screw 12mm Cruciate Head
<b>CSXT2014</b>	2mm Cortical Self Tapping Screw 14mm Cruciate Head
<b>CSXT2016</b>	2mm Cortical Self Tapping Screw 16mm Cruciate Head
<b>CSXT2018</b>	2mm Cortical Self Tapping Screw 18mm Cruciate Head
<b>CSXT2020</b>	2mm Cortical Self Tapping Screw 20mm Cruciate Head
<b>CSXT2022</b>	2mm Cortical Self Tapping Screw 22mm Cruciate Head
<b>CSXT2024</b>	2mm Cortical Self Tapping Screw 24mm Cruciate Head
<b>CSXT2026</b>	2mm Cortical Self Tapping Screw 26mm Cruciate Head
<b>CSXT2028</b>	2mm Cortical Self Tapping Screw 28mm Cruciate Head
<b>CSXT2030</b>	2mm Cortical Self Tapping Screw 30mm Cruciate Head
<b>CSXT2032</b>	2mm Cortical Self Tapping Screw 32mm Cruciate Head
<b>CSXT2034</b>	2mm Cortical Self Tapping Screw 34mm Cruciate Head
<b>CSXT2036</b>	2mm Cortical Self Tapping Screw 36mm Cruciate Head
<b>CSXT2038</b>	2mm Cortical Self Tapping Screw 38mm Cruciate Head
<b>CSXT2040</b>	2mm Cortical Self Tapping Screw 40mm Cruciate Head

### 2.0mm Cortical Screws Hex Drive

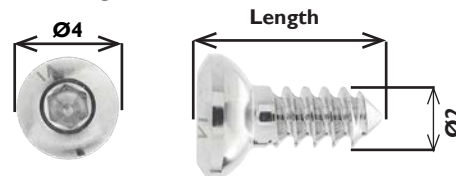

pilot drill - 1.5mm

<b>CS2006</b>	2mm Cortical Screw 6mm
<b>CS2007</b>	2mm Cortical Screw 7mm
<b>CS2008</b>	2mm Cortical Screw 8mm
<b>CS2009</b>	2mm Cortical Screw 9mm
<b>CS2010</b>	2mm Cortical Screw 10mm
<b>CS2011</b>	2mm Cortical Screw 11mm
<b>CS2012</b>	2mm Cortical Screw 12mm
<b>CS2014</b>	2mm Cortical Screw 14mm
<b>CS2016</b>	2mm Cortical Screw 16mm
<b>CS2018</b>	2mm Cortical Screw 18mm
<b>CS2020</b>	2mm Cortical Screw 20mm
<b>CS2022</b>	2mm Cortical Screw 22mm
<b>CS2024</b>	2mm Cortical Screw 24mm
<b>CS2026</b>	2mm Cortical Screw 26mm
<b>CS2028</b>	2mm Cortical Screw 28mm
<b>CS2030</b>	2mm Cortical Screw 30mm
<b>CS2032</b>	2mm Cortical Screw 32mm
<b>CS2034</b>	2mm Cortical Screw 34mm

## 2.4mm Screws 2.4mm Cortical SelfTapping Screws Star Drive

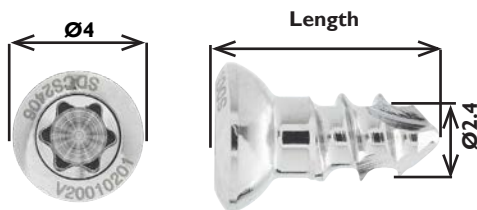

pilot drill - 1.8mm

- SDCS2406** 2.4mm Cortical Self Tapping Screw 6mm Star Drive
- SDCS2407** 2.4mm Cortical Self Tapping Screw 7mm Star Drive
- SDCS2408** 2.4mm Cortical Self Tapping Screw 8mm Star Drive
- SDCS2409** 2.4mm Cortical Self Tapping Screw 9mm Star Drive
- SDCS2410** 2.4mm Cortical Self Tapping Screw 10mm Star Drive
- SDCS2411** 2.4mm Cortical Self Tapping Screw 11mm Star Drive
- SDCS2412** 2.4mm Cortical Self Tapping Screw 12mm Star Drive
- SDCS2414** 2.4mm Cortical Self Tapping Screw 14mm Star Drive
- SDCS2416** 2.4mm Cortical Self Tapping Screw 16mm Star Drive
- SDCS2418** 2.4mm Cortical Self Tapping Screw 18mm Star Drive
- SDCS2420** 2.4mm Cortical Self Tapping Screw 20mm Star Drive
- SDCS2422** 2.4mm Cortical Self Tapping Screw 22mm Star Drive
- SDCS2424** 2.4mm Cortical Self Tapping Screw 24mm Star Drive
- SDCS2426** 2.4mm Cortical Self Tapping Screw 26mm Star Drive
- SDCS2428** 2.4mm Cortical Self Tapping Screw 28mm Star Drive
- SDCS2430** 2.4mm Cortical Self Tapping Screw 30mm Star Drive
- SDCS2432** 2.4mm Cortical Self Tapping Screw 32mm Star Drive
- SDCS2434** 2.4mm Cortical Self Tapping Screw 34mm Star Drive
- SDCS2436** 2.4mm Cortical Self Tapping Screw 36mm Star Drive
- SDCS2438** 2.4mm Cortical Self Tapping Screw 38mm Star Drive
- SDCS2440** 2.4mm Cortical Self Tapping Screw 40mm Star Drive

## 2.4mm Cortical SelfTapping Screws Hex Drive

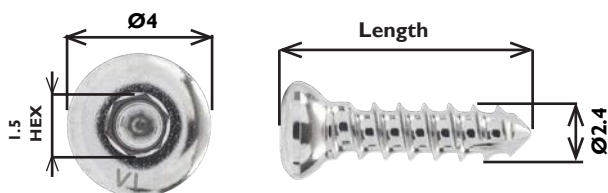

pilot drill - 1.8mm

- CSST2406** 2.4mm Self Tapping Cortical Screw 6mm
- CSST2407** 2.4mm Self Tapping Cortical Screw 7mm
- CSST2408** 2.4mm Self Tapping Cortical Screw 8mm
- CSST2409** 2.4mm Self Tapping Cortical Screw 9mm
- CSST2410** 2.4mm Self Tapping Cortical Screw 10mm
- CSST2411** 2.4mm Self Tapping Cortical Screw 11mm
- CSST2412** 2.4mm Self Tapping Cortical Screw 12mm
- CSST2414** 2.4mm Self Tapping Cortical Screw 14mm
- CSST2416** 2.4mm Self Tapping Cortical Screw 16mm
- CSST2418** 2.4mm Self Tapping Cortical Screw 18mm
- CSST2420** 2.4mm Self Tapping Cortical Screw 20mm
- CSST2422** 2.4mm Self Tapping Cortical Screw 22mm
- CSST2424** 2.4mm Self Tapping Cortical Screw 24mm
- CSST2426** 2.4mm Self Tapping Cortical Screw 26mm
- CSST2428** 2.4mm Self Tapping Cortical Screw 28mm
- CSST2430** 2.4mm Self Tapping Cortical Screw 30mm
- CSST2432** 2.4mm Self Tapping Cortical Screw 32mm
- CSST2434** 2.4mm Self Tapping Cortical Screw 34mm
- CSST2436** 2.4mm Self Tapping Cortical Screw 36mm
- CSST2438** 2.4mm Self Tapping Cortical Screw 38mm
- CSST2440** 2.4mm Self Tapping Cortical Screw 40mm

## 2.4mm Cortical SelfTapping Screws Cruciate Drive

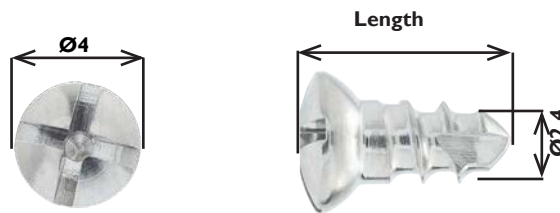

pilot drill - 1.8mm

- CSXT2406** 2.4mm Self Tapping Cortical Screw 6mm Cruciate Head
- CSXT2407** 2.4mm Self Tapping Cortical Screw 7mm Cruciate Head
- CSXT2408** 2.4mm Self Tapping Cortical Screw 8mm Cruciate Head
- CSXT2409** 2.4mm Self Tapping Cortical Screw 9mm Cruciate Head
- CSXT2410** 2.4mm Self Tapping Cortical Screw 10mm Cruciate Head
- CSXT2411** 2.4mm Self Tapping Cortical Screw 11mm Cruciate Head
- CSXT2412** 2.4mm Self Tapping Cortical Screw 12mm Cruciate Head
- CSXT2414** 2.4mm Self Tapping Cortical Screw 14mm Cruciate Head
- CSXT2416** 2.4mm Self Tapping Cortical Screw 16mm Cruciate Head
- CSXT2418** 2.4mm Self Tapping Cortical Screw 18mm Cruciate Head
- CSXT2420** 2.4mm Self Tapping Cortical Screw 20mm Cruciate Head
- CSXT2422** 2.4mm Self Tapping Cortical Screw 22mm Cruciate Head
- CSXT2424** 2.4mm Self Tapping Cortical Screw 24mm Cruciate Head
- CSXT2426** 2.4mm Self Tapping Cortical Screw 26mm Cruciate Head
- CSXT2428** 2.4mm Self Tapping Cortical Screw 28mm Cruciate Head
- CSXT2430** 2.4mm Self Tapping Cortical Screw 30mm Cruciate Head
- CSXT2432** 2.4mm Self Tapping Cortical Screw 32mm Cruciate Head
- CSXT2434** 2.4mm Self Tapping Cortical Screw 34mm Cruciate Head
- CSXT2436** 2.4mm Self Tapping Cortical Screw 36mm Cruciate Head
- CSXT2438** 2.4mm Self Tapping Cortical Screw 38mm Cruciate Head
- CSXT2440** 2.4mm Self Tapping Cortical Screw 40mm Cruciate Head

## 2.7mm Screws

### 2.7mm Cortical SelfTapping Screws

#### Star Drive

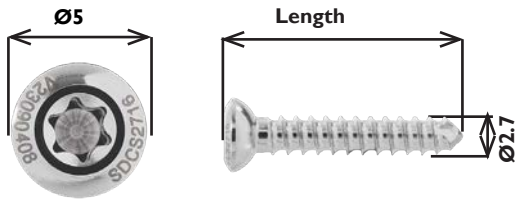

pilot drill - 2.0mm

<b>SDCS2706</b>	2.7mm Cortical Self Tapping Screw 6mm Star Drive
<b>SDCS2707</b>	2.7mm Cortical Self Tapping Screw 7mm Star Drive
<b>SDCS2708</b>	2.7mm Cortical Self Tapping Screw 8mm Star Drive
<b>SDCS2709</b>	2.7mm Cortical Self Tapping Screw 9mm Star Drive
<b>SDCS2710</b>	2.7mm Cortical Self Tapping Screw 10mm Star Drive
<b>SDCS2711</b>	2.7mm Cortical Self Tapping Screw 11mm Star Drive
<b>SDCS2712</b>	2.7mm Cortical Self Tapping Screw 12mm Star Drive
<b>SDCS2714</b>	2.7mm Cortical Self Tapping Screw 14mm Star Drive
<b>SDCS2716</b>	2.7mm Cortical Self Tapping Screw 16mm Star Drive
<b>SDCS2718</b>	2.7mm Cortical Self Tapping Screw 18mm Star Drive
<b>SDCS2720</b>	2.7mm Cortical Self Tapping Screw 20mm Star Drive
<b>SDCS2722</b>	2.7mm Cortical Self Tapping Screw 22mm Star Drive
<b>SDCS2724</b>	2.7mm Cortical Self Tapping Screw 24mm Star Drive
<b>SDCS2726</b>	2.7mm Cortical Self Tapping Screw 26mm Star Drive
<b>SDCS2728</b>	2.7mm Cortical Self Tapping Screw 28mm Star Drive
<b>SDCS2730</b>	2.7mm Cortical Self Tapping Screw 30mm Star Drive
<b>SDCS2732</b>	2.7mm Cortical Self Tapping Screw 32mm Star Drive
<b>SDCS2734</b>	2.7mm Cortical Self Tapping Screw 34mm Star Drive
<b>SDCS2736</b>	2.7mm Cortical Self Tapping Screw 36mm Star Drive
<b>SDCS2738</b>	2.7mm Cortical Self Tapping Screw 38mm Star Drive
<b>SDCS2740</b>	2.7mm Cortical Self Tapping Screw 40mm Star Drive

## 2.7mm Cortical Screws

### Hex Drive

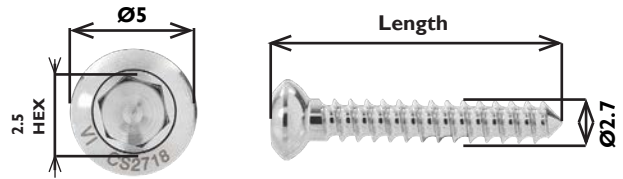

pilot drill - 2.0mm

<b>CS2706</b>	2.7mm Cortical Screw 6mm
<b>CS2707</b>	2.7mm Cortical Screw 7mm
<b>CS2708</b>	2.7mm Cortical Screw 8mm
<b>CS2709</b>	2.7mm Cortical Screw 9mm
<b>CS2710</b>	2.7mm Cortical Screw 10mm
<b>CS2711</b>	2.7mm Cortical Screw 11mm
<b>CS2712</b>	2.7mm Cortical Screw 12mm
<b>CS2713</b>	2.7mm Cortical Screw 13mm
<b>CS2714</b>	2.7mm Cortical Screw 14mm
<b>CS2716</b>	2.7mm Cortical Screw 16mm
<b>CS2718</b>	2.7mm Cortical Screw 18mm
<b>CS2720</b>	2.7mm Cortical Screw 20mm
<b>CS2722</b>	2.7mm Cortical Screw 22mm
<b>CS2724</b>	2.7mm Cortical Screw 24mm
<b>CS2726</b>	2.7mm Cortical Screw 26mm
<b>CS2728</b>	2.7mm Cortical Screw 28mm
<b>CS2730</b>	2.7mm Cortical Screw 30mm
<b>CS2732</b>	2.7mm Cortical Screw 32mm
<b>CS2734</b>	2.7mm Cortical Screw 34mm
<b>CS2736</b>	2.7mm Cortical Screw 36mm
<b>CS2738</b>	2.7mm Cortical Screw 38mm
<b>CS2740</b>	2.7mm Cortical Screw 40mm

## 2.7mm Cortical SelfTapping Screws

### Hex Drive

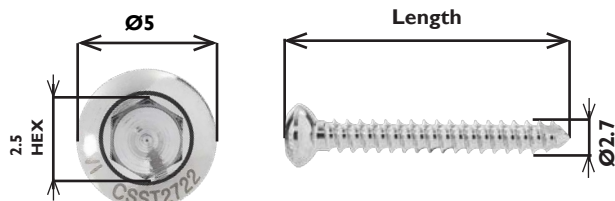

pilot drill - 2.0mm

<b>CSST2706</b>	2.7mm Cortical Self Tapping Screw 6mm
<b>CSST2708</b>	2.7mm Cortical Self Tapping Screw 8mm
<b>CSST2709</b>	2.7mm Cortical Self Tapping Screw 9mm
<b>CSST2710</b>	2.7mm Cortical Self Tapping Screw 10mm
<b>CSST2711</b>	2.7mm Cortical Self Tapping Screw 11mm
<b>CSST2712</b>	2.7mm Cortical Self Tapping Screw 12mm
<b>CSST2714</b>	2.7mm Cortical Self Tapping Screw 14mm
<b>CSST2716</b>	2.7mm Cortical Self Tapping Screw 16mm
<b>CSST2718</b>	2.7mm Cortical Self Tapping Screw 18mm
<b>CSST2720</b>	2.7mm Cortical Self Tapping Screw 20mm
<b>CSST2722</b>	2.7mm Cortical Self Tapping Screw 22mm
<b>CSST2724</b>	2.7mm Cortical Self Tapping Screw 24mm
<b>CSST2726</b>	2.7mm Cortical Self Tapping Screw 26mm
<b>CSST2728</b>	2.7mm Cortical Self Tapping Screw 28mm
<b>CSST2730</b>	2.7mm Cortical Self Tapping Screw 30mm
<b>CSST2732</b>	2.7mm Cortical Self Tapping Screw 32mm
<b>CSST2734</b>	2.7mm Cortical Self Tapping Screw 34mm
<b>CSST2736</b>	2.7mm Cortical Self Tapping Screw 36mm
<b>CSST2738</b>	2.7mm Cortical Self Tapping Screw 38mm
<b>CSST2740</b>	2.7mm Cortical Self Tapping Screw 40mm

**3.5mm Screws**  
**3.5mm Cortical Self Tapping Screws**  
**Star Drive**

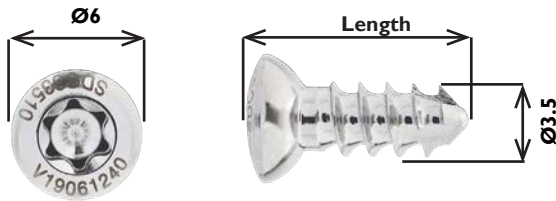

pilot drill - 2.5mm

- SDCS3508** 3.5mm Cortical Self Tapping Screw 8mm Star Drive
- SDCS3509** 3.5mm Cortical Self Tapping Screw 9mm Star Drive
- SDCS3510** 3.5mm Cortical Self Tapping Screw 10mm Star Drive
- SDCS3511** 3.5mm Cortical Self Tapping Screw 11mm Star Drive
- SDCS3512** 3.5mm Cortical Self Tapping Screw 12mm Star Drive
- SDCS3513** 3.5mm Cortical Self Tapping Screw 13mm Star Drive
- SDCS3514** 3.5mm Cortical Self Tapping Screw 14mm Star Drive
- SDCS3515** 3.5mm Cortical Self Tapping Screw 15mm Star Drive
- SDCS3516** 3.5mm Cortical Self Tapping Screw 16mm Star Drive
- SDCS3518** 3.5mm Cortical Self Tapping Screw 18mm Star Drive
- SDCS3520** 3.5mm Cortical Self Tapping Screw 20mm Star Drive
- SDCS3522** 3.5mm Cortical Self Tapping Screw 22mm Star Drive
- SDCS3524** 3.5mm Cortical Self Tapping Screw 24mm Star Drive
- SDCS3526** 3.5mm Cortical Self Tapping Screw 26mm Star Drive
- SDCS3528** 3.5mm Cortical Self Tapping Screw 28mm Star Drive
- SDCS3530** 3.5mm Cortical Self Tapping Screw 30mm Star Drive
- SDCS3532** 3.5mm Cortical Self Tapping Screw 32mm Star Drive
- SDCS3534** 3.5mm Cortical Self Tapping Screw 34mm Star Drive
- SDCS3536** 3.5mm Cortical Self Tapping Screw 36mm Star Drive
- SDCS3538** 3.5mm Cortical Self Tapping Screw 38mm Star Drive
- SDCS3540** 3.5mm Cortical Self Tapping Screw 40mm Star Drive
- SDCS3542** 3.5mm Cortical Self Tapping Screw 42mm Star Drive
- SDCS3544** 3.5mm Cortical Self Tapping Screw 44mm Star Drive
- SDCS3545** 3.5mm Cortical Self Tapping Screw 45mm Star Drive
- SDCS3546** 3.5mm Cortical Self Tapping Screw 46mm Star Drive
- SDCS3548** 3.5mm Cortical Self Tapping Screw 48mm Star Drive
- SDCS3550** 3.5mm Cortical Self Tapping Screw 50mm Star Drive
- SDCS3555** 3.5mm Cortical Self Tapping Screw 55mm Star Drive
- SDCS3560** 3.5mm Cortical Self Tapping Screw 60mm Star Drive

**3.5mm Cortical Self Tapping Screws**  
**Hex Drive**

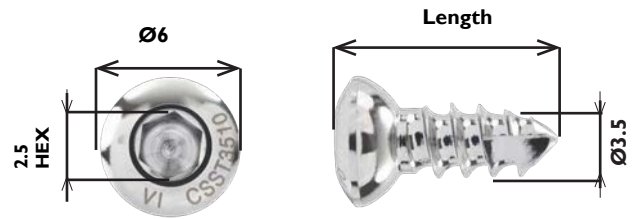

pilot drill - 2.5mm

- CSST3508** 3.5mm Self Tapping Cortical Screw 8mm
- CSST3510** 3.5mm Self Tapping Cortical Screw 10mm
- CSST3511** 3.5mm Self Tapping Cortical Screw 11mm
- CSST3512** 3.5mm Self Tapping Cortical Screw 12mm
- CSST3514** 3.5mm Self Tapping Cortical Screw 14mm
- CSST3515** 3.5mm Self Tapping Cortical Screw 15mm
- CSST3516** 3.5mm Self Tapping Cortical Screw 16mm
- CSST3518** 3.5mm Self Tapping Cortical Screw 18mm
- CSST3520** 3.5mm Self Tapping Cortical Screw 20mm
- CSST3522** 3.5mm Self Tapping Cortical Screw 22mm
- CSST3524** 3.5mm Self Tapping Cortical Screw 24mm
- CSST3526** 3.5mm Self Tapping Cortical Screw 26mm
- CSST3528** 3.5mm Self Tapping Cortical Screw 28mm
- CSST3530** 3.5mm Self Tapping Cortical Screw 30mm
- CSST3532** 3.5mm Self Tapping Cortical Screw 32mm
- CSST3534** 3.5mm Self Tapping Cortical Screw 34mm
- CSST3536** 3.5mm Self Tapping Cortical Screw 36mm
- CSST3538** 3.5mm Self Tapping Cortical Screw 38mm
- CSST3540** 3.5mm Self Tapping Cortical Screw 40mm
- CSST3542** 3.5mm Self Tapping Cortical Screw 42mm
- CSST3544** 3.5mm Self Tapping Cortical Screw 44mm
- CSST3545** 3.5mm Self Tapping Cortical Screw 45mm
- CSST3546** 3.5mm Self Tapping Cortical Screw 46mm
- CSST3548** 3.5mm Self Tapping Cortical Screw 48mm
- CSST3550** 3.5mm Self Tapping Cortical Screw 50mm
- CSST3555** 3.5mm Self Tapping Cortical Screw 55mm
- CSST3560** 3.5mm Self Tapping Cortical Screw 60mm

### 3.5mm Cortical Screws Hex Drive

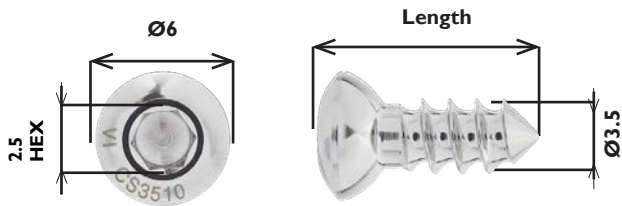

**pilot drill - 2.5mm**

<b>CS3508</b>	3.5mm Cortical Screw 8mm
<b>CS3510</b>	3.5mm Cortical Screw 10mm
<b>CS3512</b>	3.5mm Cortical Screw 12mm
<b>CS3514</b>	3.5mm Cortical Screw 14mm
<b>CS3515</b>	3.5mm Cortical Screw 15mm
<b>CS3516</b>	3.5mm Cortical Screw 16mm
<b>CS3518</b>	3.5mm Cortical Screw 18mm
<b>CS3520</b>	3.5mm Cortical Screw 20mm
<b>CS3522</b>	3.5mm Cortical Screw 22mm
<b>CS3524</b>	3.5mm Cortical Screw 24mm
<b>CS3526</b>	3.5mm Cortical Screw 26mm
<b>CS3528</b>	3.5mm Cortical Screw 28mm
<b>CS3530</b>	3.5mm Cortical Screw 30mm
<b>CS3532</b>	3.5mm Cortical Screw 32mm
<b>CS3534</b>	3.5mm Cortical Screw 34mm
<b>CS3536</b>	3.5mm Cortical Screw 36mm
<b>CS3538</b>	3.5mm Cortical Screw 38mm
<b>CS3540</b>	3.5mm Cortical Screw 40mm
<b>CS3542</b>	3.5mm Cortical Screw 42mm
<b>CS3544</b>	3.5mm Cortical Screw 44mm
<b>CS3545</b>	3.5mm Cortical Screw 45mm
<b>CS3546</b>	3.5mm Cortical Screw 46mm
<b>CS3548</b>	3.5mm Cortical Screw 48mm
<b>CS3550</b>	3.5mm Cortical Screw 50mm
<b>CS3555</b>	3.5mm Cortical Screw 55mm
<b>CS3560</b>	3.5mm Cortical Screw 60mm
<b>CS3565</b>	3.5mm Cortical Screw 65mm
<b>CS3570</b>	3.5mm Cortical Screw 70mm
<b>CS3575</b>	3.5mm Cortical Screw 75mm
<b>CS3580</b>	3.5mm Cortical Screw 80mm
<b>CS3585</b>	3.5mm Cortical Screw 85mm



### Loan Kits

For a nominal fee, we have a range of **specialist loan kits** available to complement your own fleet. With next working day availability, the service offers flexibility as procedures are booked with your clients.

To find out more, scan the QR code below.



**4.5mm Screws**  
**4.5mm Cortical Self Tapping Screws**  
**Hex Drive**

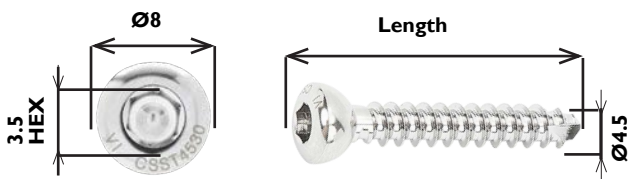

pilot drill - 3.2mm

- CSST4512 4.5mm Self Tapping Cortical Screw 12mm
- CSST4514 4.5mm Self Tapping Cortical Screw 14mm
- CSST4516 4.5mm Self Tapping Cortical Screw 16mm
- CSST4518 4.5mm Self Tapping Cortical Screw 18mm
- CSST4520 4.5mm Self Tapping Cortical Screw 20mm
- CSST4522 4.5mm Self Tapping Cortical Screw 22mm
- CSST4524 4.5mm Self Tapping Cortical Screw 24mm
- CSST4526 4.5mm Self Tapping Cortical Screw 26mm
- CSST4528 4.5mm Self Tapping Cortical Screw 28mm
- CSST4530 4.5mm Self Tapping Cortical Screw 30mm
- CSST4532 4.5mm Self Tapping Cortical Screw 32mm
- CSST4534 4.5mm Self Tapping Cortical Screw 34mm
- CSST4536 4.5mm Self Tapping Cortical Screw 36mm
- CSST4538 4.5mm Self Tapping Cortical Screw 38mm
- CSST4540 4.5mm Self Tapping Cortical Screw 40mm
- CSST4542 4.5mm Self Tapping Cortical Screw 42mm
- CSST4544 4.5mm Self Tapping Cortical Screw 44mm
- CSST4546 4.5mm Self Tapping Cortical Screw 46mm
- CSST4548 4.5mm Self Tapping Cortical Screw 48mm
- CSST4550 4.5mm Self Tapping Cortical Screw 50mm
- CSST4552 4.5mm Self Tapping Cortical Screw 52mm
- CSST4554 4.5mm Self Tapping Cortical Screw 54mm
- CSST4556 4.5mm Self Tapping Cortical Screw 56mm
- CSST4558 4.5mm Self Tapping Cortical Screw 58mm
- CSST4560 4.5mm Self Tapping Cortical Screw 60mm
- CSST4562 4.5mm Self Tapping Cortical Screw 62mm
- CSST4564 4.5mm Self Tapping Cortical Screw 64mm
- CSST4566 4.5mm Self Tapping Cortical Screw 66mm
- CSST4568 4.5mm Self Tapping Cortical Screw 68mm
- CSST4570 4.5mm Self Tapping Cortical Screw 70mm
- CSST4575 4.5mm Self Tapping Cortical Screw 75mm
- CSST4580 4.5mm Self Tapping Cortical Screw 80mm
- CSST4585 4.5mm Self Tapping Cortical Screw 85mm

**4.5mm Cortical Screws**  
**Hex Drive**

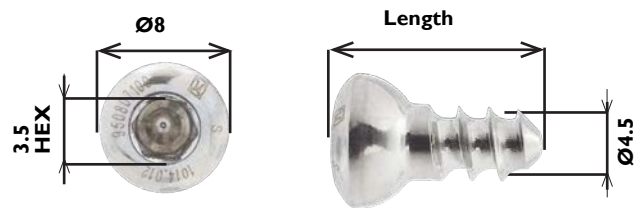

pilot drill - 3.2mm

- CS4512 4.5mm Cortical Screw 12mm
- CS4514 4.5mm Cortical Screw 14mm
- CS4516 4.5mm Cortical Screw 16mm
- CS4518 4.5mm Cortical Screw 18mm
- CS4520 4.5mm Cortical Screw 20mm
- CS4522 4.5mm Cortical Screw 22mm
- CS4524 4.5mm Cortical Screw 24mm
- CS4526 4.5mm Cortical Screw 26mm
- CS4528 4.5mm Cortical Screw 28mm
- CS4530 4.5mm Cortical Screw 30mm
- CS4532 4.5mm Cortical Screw 32mm
- CS4534 4.5mm Cortical Screw 34mm
- CS4536 4.5mm Cortical Screw 36mm
- CS4538 4.5mm Cortical Screw 38mm
- CS4540 4.5mm Cortical Screw 40mm
- CS4542 4.5mm Cortical Screw 42mm
- CS4544 4.5mm Cortical Screw 44mm
- CS4546 4.5mm Cortical Screw 46mm
- CS4548 4.5mm Cortical Screw 48mm
- CS4550 4.5mm Cortical Screw 50mm
- CS4552 4.5mm Cortical Screw 52mm
- CS4554 4.5mm Cortical Screw 54mm
- CS4556 4.5mm Cortical Screw 56mm
- CS4558 4.5mm Cortical Screw 58mm
- CS4560 4.5mm Cortical Screw 60mm
- CS4562 4.5mm Cortical Screw 62mm
- CS4564 4.5mm Cortical Screw 64mm
- CS4566 4.5mm Cortical Screw 66mm
- CS4568 4.5mm Cortical Screw 68mm
- CS4570 4.5mm Cortical Screw 70mm
- CS4575 4.5mm Cortical Screw 75mm
- CS4580 4.5mm Cortical Screw 80mm
- CS4585 4.5mm Cortical Screw 85mm

## 5.5mm Screws

### 5.5mm Cortical Screws

#### Hex Drive

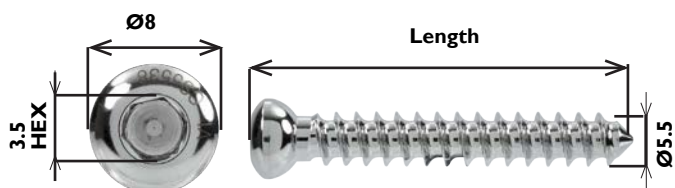

pilot drill - 4.0mm

CS5524	5.5mm Cortical Screw 24mm
CS5526	5.5mm Cortical Screw 26mm
CS5528	5.5mm Cortical Screw 28mm
CS5530	5.5mm Cortical Screw 30mm
CS5532	5.5mm Cortical Screw 32mm
CS5534	5.5mm Cortical Screw 34mm
CS5536	5.5mm Cortical Screw 36mm
CS5538	5.5mm Cortical Screw 38mm
CS5540	5.5mm Cortical Screw 40mm
CS5542	5.5mm Cortical Screw 42mm
CS5544	5.5mm Cortical Screw 44mm
CS5546	5.5mm Cortical Screw 46mm
CS5548	5.5mm Cortical Screw 48mm
CS5550	5.5mm Cortical Screw 50mm
CS5552	5.5mm Cortical Screw 52mm
CS5554	5.5mm Cortical Screw 54mm
CS5556	5.5mm Cortical Screw 56mm
CS5560	5.5mm Cortical Screw 60mm
CS5564	5.5mm Cortical Screw 64mm
CS5570	5.5mm Cortical Screw 70mm
CS5580	5.5mm Cortical Screw 80mm
CS5590	5.5mm Cortical Screw 90mm
CS55100	5.5mm Cortical Screw 100mm



### ViPP

Through a true partnership approach, you can deliver quantifiable rewards for you and your Practice by joining our **Veterinary Instrumentation Partnership Programme**.

To find out more, scan the QR code below.



### Cancellous Screws

#### Hex Drive

#### 2.2mm Cancellous Screws

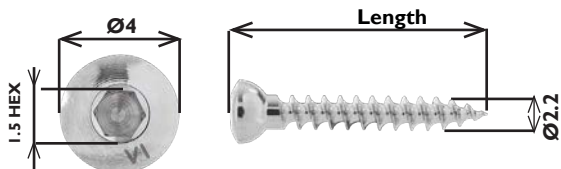

pilot drill - 1.5mm

- CAN2208** 2.2mm Self Tapping Cancellous Screw 8mm
- CAN2210** 2.2mm Self Tapping Cancellous Screw 10mm
- CAN2212** 2.2mm Self Tapping Cancellous Screw 12mm
- CAN2214** 2.2mm Self Tapping Cancellous Screw 14mm
- CAN2216** 2.2mm Self Tapping Cancellous Screw 16mm
- CAN2218** 2.2mm Self Tapping Cancellous Screw 18mm
- CAN2220** 2.2mm Self Tapping Cancellous Screw 20mm
- CAN2222** 2.2mm Self Tapping Cancellous Screw 22mm
- CAN2224** 2.2mm Self Tapping Cancellous Screw 24mm

#### 3.0mm Cancellous Screws

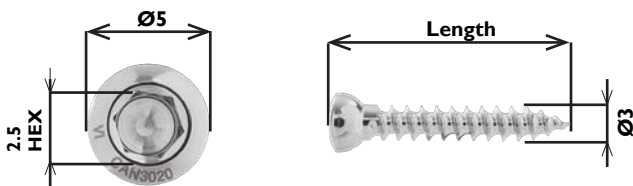

pilot drill - 2.0mm

- CAN3012** 3mm Self Tapping Cancellous Screw 12mm
- CAN3014** 3mm Self Tapping Cancellous Screw 14mm
- CAN3016** 3mm Self Tapping Cancellous Screw 16mm
- CAN3018** 3mm Self Tapping Cancellous Screw 18mm
- CAN3020** 3mm Self Tapping Cancellous Screw 20mm
- CAN3022** 3mm Self Tapping Cancellous Screw 22mm
- CAN3024** 3mm Self Tapping Cancellous Screw 24mm
- CAN3026** 3mm Self Tapping Cancellous Screw 26mm
- CAN3028** 3mm Self Tapping Cancellous Screw 28mm
- CAN3030** 3mm Self Tapping Cancellous Screw 30mm
- CAN3032** 3mm Self Tapping Cancellous Screw 32mm
- CAN3034** 3mm Self Tapping Cancellous Screw 34mm
- CAN3036** 3mm Self Tapping Cancellous Screw 36mm

### 3.5mm Cancellous Screws

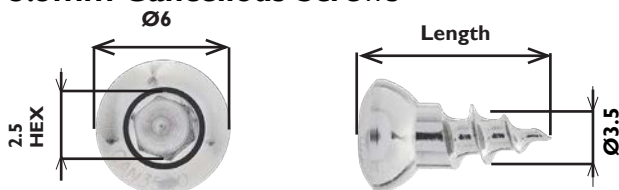

pilot drill - 2.0mm

- CAN3510** 3.5mm Cancellous Screw 10mm
- CAN3512** 3.5mm Cancellous Screw 12mm
- CAN3514** 3.5mm Cancellous Screw 14mm
- CAN3516** 3.5mm Cancellous Screw 16mm
- CAN3518** 3.5mm Cancellous Screw 18mm
- CAN3520** 3.5mm Cancellous Screw 20mm
- CAN3522** 3.5mm Cancellous Screw 22mm
- CAN3524** 3.5mm Cancellous Screw 24mm
- CAN3526** 3.5mm Cancellous Screw 26mm
- CAN3528** 3.5mm Cancellous Screw 28mm
- CAN3530** 3.5mm Cancellous Screw 30mm
- CAN3532** 3.5mm Cancellous Screw 32mm
- CAN3534** 3.5mm Cancellous Screw 34mm
- CAN3536** 3.5mm Cancellous Screw 36mm
- CAN3538** 3.5mm Cancellous Screw 38mm
- CAN3540** 3.5mm Cancellous Screw 40mm
- CAN3545** 3.5mm Cancellous Screw 45mm
- CAN3550** 3.5mm Cancellous Screw 50mm
- CAN3555** 3.5mm Cancellous Screw 55mm
- CAN3560** 3.5mm Cancellous Screw 60mm

### 4.0mm Cancellous Screws Part Threaded

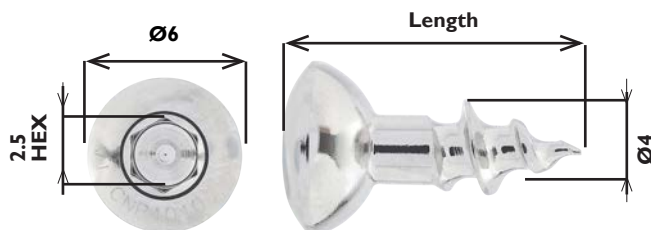

pilot drill - 2.5mm

- CNP4010** 4mm Part Thread Cancellous Screws 10mm
- CNP4012** 4mm Part Thread Cancellous Screws 12mm
- CNP4014** 4mm Part Thread Cancellous Screws 14mm
- CNP4016** 4mm Part Thread Cancellous Screws 16mm
- CNP4018** 4mm Part Thread Cancellous Screws 18mm
- CNP4020** 4mm Part Thread Cancellous Screws 20mm
- CNP4022** 4mm Part Thread Cancellous Screws 22mm
- CNP4024** 4mm Part Thread Cancellous Screws 24mm
- CNP4026** 4mm Part Thread Cancellous Screws 26mm
- CNP4028** 4mm Part Thread Cancellous Screws 28mm
- CNP4030** 4mm Part Thread Cancellous Screws 30mm
- CNP4035** 4mm Part Thread Cancellous Screws 35mm
- CNP4040** 4mm Part Thread Cancellous Screws 40mm
- CNP4045** 4mm Part Thread Cancellous Screws 45mm
- CNP4050** 4mm Part Thread Cancellous Screws 50mm
- CNP4055** 4mm Part Thread Cancellous Screws 55mm
- CNP4060** 4mm Part Thread Cancellous Screws 60mm



## 4.0mm Cancellous Screws

### Full Threaded

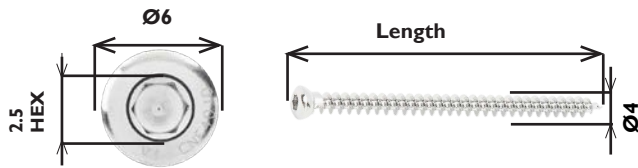

pilot drill - 2.5mm

CNF4010	4mm Fully Threaded Cancellous Screws 10mm
CNF4012	4mm Fully Threaded Cancellous Screws 12mm
CNF4014	4mm Fully Threaded Cancellous Screws 14mm
CNF4016	4mm Fully Threaded Cancellous Screws 16mm
CNF4018	4mm Fully Threaded Cancellous Screws 18mm
CNF4020	4mm Fully Threaded Cancellous Screws 20mm
CNF4022	4mm Fully Threaded Cancellous Screws 22mm
CNF4024	4mm Fully Threaded Cancellous Screws 24mm
CNF4026	4mm Fully Threaded Cancellous Screws 26mm
CNF4028	4mm Fully Threaded Cancellous Screws 28mm
CNF4030	4mm Fully Threaded Cancellous Screws 30mm
CNF4032	4mm Fully Threaded Cancellous Screws 32mm
CNF4034	4mm Fully Threaded Cancellous Screws 34mm
CNF4035	4mm Fully Threaded Cancellous Screws 35mm
CNF4036	4mm Fully Threaded Cancellous Screws 36mm
CNF4038	4mm Fully Threaded Cancellous Screws 38mm
CNF4040	4mm Fully Threaded Cancellous Screws 40mm
CNF4045	4mm Fully Threaded Cancellous Screws 45mm
CNF4050	4mm Fully Threaded Cancellous Screws 50mm
CNF4055	4mm Fully Threaded Cancellous Screws 55mm
CNF4060	4mm Fully Threaded Cancellous Screws 60mm

## 6.5mm Cancellous Screws

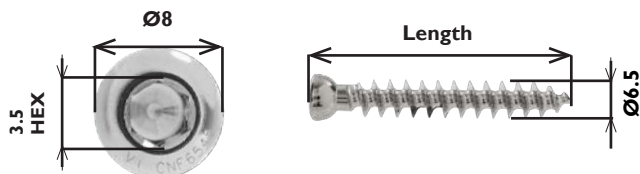

pilot drill - 3.2mm

CNF6525	6.5mm Fully Threaded Cancellous Screws 25mm
CNF6530	6.5mm Fully Threaded Cancellous Screws 30mm
CNF6535	6.5mm Fully Threaded Cancellous Screws 35mm
CNF6540	6.5mm Fully Threaded Cancellous Screws 40mm
CNF6545	6.5mm Fully Threaded Cancellous Screws 45mm
CNF6550	6.5mm Fully Threaded Cancellous Screws 50mm
CNF6555	6.5mm Fully Threaded Cancellous Screws 55mm
CNF6560	6.5mm Fully Threaded Cancellous Screws 60mm
CNF6565	6.5mm Fully Threaded Cancellous Screws 65mm
CNF6570	6.5mm Fully Threaded Cancellous Screws 70mm
CNF6575	6.5mm Fully Threaded Cancellous Screws 75mm

### Screwdrivers Modular Screwdrivers



**E17-079** Soft Touch Quick Release Handle - AO Fit



**QRCH18** Quick Release Handle - AO Fit



**D17-080** Soft Touch Quick Release Handle - Dental Fit



**DC20-A** Quick Release Handle - Dental Fit

### Star Drive Screwdriver Inserts To Fit Modular Handles



- SDT415-A** Star Drive Insert for 1.5mm Star Drive Screws (Fits D17-080)
- SDT620-A** Star Drive Insert for 2.0mm Star Drive Screws (Fits D17-080)
- SDT82427** Star Drive Insert for 2.4/2.7mm Star Drive Screws (Fits E17-079)
- SDT1535** Star Drive Insert for 3.5mm Star Drive Screws (Fits E17-079)
- SDTSET-A** Quick Release & Dental Fit Handles & Star Drive Insert Set 1.5mm - 3.5mm

### Cruciate Drive Screwdriver Inserts To Fit Modular Handles



- SDINI.0-A** Dental Fit Screwdriver Insert For 1.0mm Screws (Fits D17-080)
- SDXQRDI520-A** Cruciate Screwdriver Insert For 1.5/2.0mm Screws (Fits D17-080)
- SDXQR24** Cruciate Screwdriver Insert For 2.4mm Screws (E17-079)

### Hex Drive Screwdriver Inserts To Fit Modular Handles



- SDD1500-A** 1.5/2.0/2.4mm Hex Dental Fit Screwdriver Attachment (Fits D17-080)
- SDH355** Hex Screwdriver Insert For 2.7/3.5/4.0mm Screws (Fits E17-079)
- SDHS455** Hex Screwdriver Insert For 4.5mm+ Screws (Fits E17-079)

### Cruciate Head Screwdrivers For 1.5mm, 2.0mm & 2.4mm Screws



- SDX1520** Cruciate Screwdriver For 1.5mm/2.0mm Screws
- SDX24** Cruciate Screwdriver 2.4mm Screws

### Hex Screwdriver For 1.5mm, 2.0mm & 2.4mm Screws



- SDHS20-I** 1.5mm Hex Screwdriver/Sleeve PTFE Handle For 1.5mm/2.0mm/2.4mm Screws 125mm
- SSH2000** Screwholding Sleeve To Fit SDHS20-I

### Hex Screwdriver For 2.7mm, 3.5mm & 4.0mm Screws



- SDHS35POM-C** 2.5mm Hex Screwdriver + Sleeve With PTFE Handle For 2.7mm/3.5mm/4.0mm Screws, 200mm
- SSH273540** Replacement Screwholding Sleeve To Fit SDHS35POM-C

### Hex Screwdriver For 4.5mm, 5.5mm & 6.5mm Screws



- SDH4500** Hex Screwdriver For 4.5/5.5/6.5mm Screws Without Sleeve

### Hex Drive Shaft

Hex drive screwdriver extensions for standard Jacob's Chuck on power drills. Whilst it is advised that the final tightening of the screw is performed by hand, time & effort can be saved by power driving.

- DS25HEX** 2.5 Hex Drive Shaft for 2.7mm, 3.5mm & 4.0mm Screws
- DS35HEX** 3.5 Hex Drive Shaft for 4.5mm & 5.5mm Screws

## Tap Devices

### Modular Tap Devices



**E17-079** Soft Touch Quick Release Handle - AO Fit



**D17-080** Soft Touch Quick Release Handle - Dental Fit



**T19-095** Soft Touch T-Bar Handle Quick Release - AO Fit

### Modular Cortical Taps



- TD0015-A** 1.5mm Cortical Tap (Fits D17-080)
- TD0020-A** 2.0mm Cortical Tap (Fits D17-080)
- TS0024** 2.4mm Cortical Tap (Fits E17-079 & T19-095)
- TS00027** 2.7mm Cortical Tap (Fits E17-079 & T19-095)
- TS12535** 3.5mm Cortical Tap (Fits E17-079 & T19-095)
- TS17535** 3.5mm Small Cancellous Tap (Fits E17-079 & T19-095)
- TS00045** 4.5mm Cortical Tap (Fits E17-079 & T19-095)
- TS00045L** 4.5mm Extra Long Tap (195mm Long) 100mm Thread (Fits E17-079 & T19-095)

### Modular Locking Taps



- TSL20-A** Tap for 2.0mm Locking Screws (Fits D17-080)
- TSL24** Tap for 2.4mm Locking Screws (Fits E17-079 & T19-095)
- TSL27** Tap for 2.7mm Locking Screws (Fits E17-079 & T19-095)
- TSL35** Tap for 3.5mm Locking Screws (Fits E17-079 & T19-095)
- TSLSET-A** Locking Screw Tap Set. 4 Taps and 2 handles

### 5.5mm Tap - Quick Release Square Fit



**TQH55** Handle for 5.5mm Cortical Tap - Square Fit  
**TQ00055** 5.5mm Cortical Tap - Square Fit

### T Bar Cortical Taps - Fixed Handle



- TBT015** T Bar Tap 1.5mm Cortical
- TBT020** T Bar Tap 2.0mm Cortical
- TBT027** T Bar Tap 2.7mm Cortical
- TBT12535** T Bar Tap 3.5mm Cortical
- TBT17535** T Bar Tap 3.5mm Small Cancellous
- TBT065** T Bar Tap 6.5mm Cancellous

## Countersinks Modular Countersinks



**E17-079** Soft Touch Quick Release Handle - AO Fit



**D17-080** Soft Touch Quick Release Handle - Dental Fit



**T19-095** Soft Touch T-Bar Handle Quick Release - AO Fit

## Countersinks - Quick Release



If the screw is destined to screw down onto the surface of the bone without a plate, it is helpful to contour the top of the screw hole to fit the screw head. This procedure is especially important when lag screwing relatively small fragments. Failure to countersink may lead to fracture of the bone fragment.

- COU1520QRD** Quick Release Countersink For 1.5/2.0mm Screws (Fits D17-080)
- COU2427QR** Quick Release Countersink For 2.4/2.7mm Screws (Fits E17-079 & T19-095)
- COU3540QR** Quick Release Countersink For 3.5/4.0mm Screws (Fits E17-079 & T19-095)
- COU4565QR** Quick Release Countersink For 4.5/6.5mm Screws (Fits E17-079 & T19-095)

## Countersinks - Fixed Handle

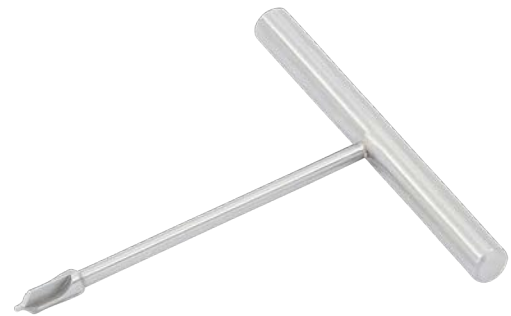

- COU1520T-A** T Bar Countersink for 1.5/2.0mm Screws
- COU2427T-A** T Bar Countersink for 2.4/2.7mm Screws
- COU3540T-A** T Bar Countersink for 3.5/4.0mm Screws
- COU4565T-A** T Bar Countersink for 4.5 - 6.5mm Screws



### Loan Kits

For a nominal fee, we have a range of **specialist loan kits** available to complement your own fleet. With next working day availability, the service offers flexibility as procedures are booked with your clients.

To find out more, scan the QR code below.



## Drill Bits

### Drill Bits - Round Shank

Round shank multi-use drill bits made from hardened stainless steel, suitable for use with a standard Jacobs chuck.



#### Standard Length

Suitable for most applications.

	Diameter (mm)	Total Length (mm)	Flute Length (mm)
H090100	1.1	70	20
H090101	1.5	90	20
H090208	1.8	110	25
H090202	1.9	110	25
H090102	2.0	110	30
H090203	2.3	120	30
H090209	2.4	120	30
H090112	2.5	120	30
H090104	2.7	130	40
H090103	2.8	130	40
H090205	3.0	130	40
H090105S	3.2	130	40
H090106S	3.5	130	50
H090207	3.8	130	50
H090107S	4.0	130	50
H090108S	4.5	130	50
H090109S	5.5	130	60

#### Long Length

	Diameter (mm)	Total Length (mm)	Flute Length (mm)
H090101L	1.5	120	20
H090208L	1.8	140	25
H090102L	2.0	140	30
H090209L	2.4	150	30
H090112L	2.5	150	30
H090104L	2.7	170	40
H090103L	2.8	170	40
H090105L	3.2	180	40
H090106L	3.5	180	50
H090107/L	4.0	180	50
H090108L	4.5	180	50
H090109/L	5.5	180	60

Please note that longer drill bits are more prone to snapping & it is more difficult to control the hole angle & accuracy – therefore standard length drill bits should be used where possible. Where a longer drill bit is required it should be used with particular care & attention; use of a long drill guide may help to minimise problems.

### Drill Bits - Quick Release AO Fit

Quick release multi-use drill bits made from hardened stainless steel, suitable for use with an AO style quick release chuck.



#### Standard Length

Suitable for most applications.

	Diameter (mm)	Total Length (mm)	Flute Length (mm)
S090100S	1.1	80	20
S090101S	1.5	100	20
S090208	1.8	110	25
S090102S	2.0	110	30
S090209	2.4	120	30
S090112S	2.5	130	30
S090104S	2.7	130	40
S090103S	2.8	140	40
S090105S	3.2	140	40
S090106S	3.5	140	50
S090107	4.0	170	50
S090108S	4.5	140	50
S090109	5.5	170	50

#### Long Length

	Diameter (mm)	Total Length (mm)	Flute Length (mm)
S090100L	1.1	110	20
S090101L	1.5	130	20
S090208L	1.8	140	25
S090102L	2.0	140	30
S090209L	2.4	170	30
S090112L	2.5	180	30
S090104L	2.7	180	40
S090103L	2.8	190	40
S090105L	3.2	190	40
S090106L	3.5	190	50
S090108L	4.5	190	50

### Mini Quick Release Drill Bits - Dental Fit

These smaller drill bits are too delicate for use with a power drill, & are designed for use with the D17-080 dental fit handle. This improves control & helps prevent breakages.

- I0MDB07-A 0.7mm Drill Bit Dental Fit 60mm
- I0MDB10-A 1.0mm Drill Bit Dental Fit 60mm

## Drill Bits - Anti-Skid - Round Shank



Anti-skid drill bits have a special tip which bites into the bone surface, accurately positioning the hole. Particularly useful for holes which are not perpendicular to the bone surface, & where a drill guide is not used.

Round shank multi-use drill bits made from hardened stainless steel, suitable for use with a standard Jacobs chuck.

	Diameter (mm)	Total Length (mm)	Flute Length (mm)
<b>H090101AS</b>	1.5	90	20
<b>H090208AS</b>	1.8	110	25
<b>H090102AS</b>	2	110	30
<b>H090209AS</b>	2.4	120	30
<b>H090112AS</b>	2.5	120	30
<b>H090104AS</b>	2.7	130	40
<b>H090105SAS</b>	3.2	130	40
<b>H090106SAS</b>	3.5	130	50
<b>H090108SAS</b>	4.5	130	50

## Drill Bits - Cannulated - Round Shank & AO Fit



For use with a 1.1mm guide wire for accurate placement of holes.

### Round Shank

Round shank multi-use cannulated drill bits made from hardened stainless steel, suitable for use with a standard Jacobs chuck.

	Diameter (mm)	Total Length (mm)	Flute Length (mm)
<b>H090112CAN</b>	2.5	130	25
<b>H090104CAN</b>	2.7	130	30
<b>H090106CAN</b>	3.5	130	35

### Quick Release AO Fit

Quick release multi-use cannulated drill bits made from hardened stainless steel, suitable for use with an AO style quick release chuck.



	Diameter (mm)	Total Length (mm)	Flute Length (mm)
<b>S090112CAN</b>	2.5	105	25
<b>S090104CAN</b>	2.7	105	30
<b>S090106CAN</b>	3.5	105	35

## Pre-Drilling ESF Pin Tracts



Pre-drilling a pin tract hole in the bone into which the ESF pin is subsequently inserted is very important as the ESF pins do not have drilling ends. Otherwise insertion of an ESF pin directly into the bone may cause impaction, micro-fracturing of the bone & excessive heat production with bone necrosis, all of which can lead to pin loosening. A drill bit that is about 10% smaller than the shank (core) diameter of the pin, or at least 0.1mm smaller, should be used. A slow speed (electric) drill at about 150rpm is advisable, using flush to cool the pin & minimise heat generated in the bone that could cause bone necrosis & pin loosening. An appropriate drill guide is used to protect the soft tissues & minimise drill wobble & skidding. Once the hole is drilled, a K-wire can be used to maintain the pin tract (before the drill guide is removed) so it can be easily re-identified once the ESF pin is ready to be inserted.

- H090202** 1.9mm Pre-Drill For 2.0mm Shank Positive Pin
- H090203** 2.3mm Pre-Drill For 2.4mm Shank Positive Pin
- H090205** 3.0mm Pre-Drill For 3.2mm Shank Positive Pin
- H090207** 3.8mm Pre-Drill For 4.0mm Shank Positive Pin
- H090101** 1.5mm Pre-Drill For 2.0mm Shank Negative Pin
- H090102** 2.0mm Pre-Drill For 2.4mm Shank Negative Pin
- H090104** 2.7mm Pre-Drill For 3.2mm Shank Negative Pin
- H090106L** 3.5mm Pre-Drill For 4.0mm Shank Negative Pin

## Drill Stops



Drilling to a pre-measured depth can be a challenge. A drill stop is tightened onto the drill bit at the required depth. The Set includes 4 Stops to cover all the standard drill sizes. 1.5mm, 2.0mm, 2.5mm, 2.7mm, 3.2mm, 3.5mm & 4.5mm. The stop is tightened onto the drill bit using the hex driver provided.

**DRILLSTOP** Drill Stop Set in Stainless Case

## Wires & Pins

Wires are simple, but versatile implants. Our specially selected stainless steel wires are both very hard & very stiff improving their driving characteristics & performance in situ.

Cutting with sufficiently robust implant cutters with hard jaws is obligatory.

These wires will damage cutters with stainless steel edges, eg: combined wire twisters/shear cutters.

### Arthrodesis Wire 125mm Long

Rather like small Intra-medullary Pins, Arthrodesis Wires have trochar points at each end.

They are used for the fixation of small bone fragments, produced either electively or as a result of trauma, e.g. distal femoral fractures, tibial crest transplants & femoral neck fractures. 125mm Long. Supplied in packs of ten.

<b>090054ART</b>	0.8mm Arthrodesis Wire 125mm Pack of 10
<b>090020ART</b>	0.9mm Arthrodesis Wire 125mm Pack of 10
<b>090060ART</b>	1.0mm Arthrodesis Wire 125mm Pack of 10
<b>090021ART</b>	1.1mm Arthrodesis Wire 125mm Pack of 10
<b>090061ART</b>	1.25mm Arthrodesis Wire 125mm Pack of 10
<b>090024ART</b>	1.4mm Arthrodesis Wire 125mm Pack of 10
<b>090062ART</b>	1.5mm Arthrodesis Wire 125mm Pack of 10
<b>090022ART</b>	1.6mm Arthrodesis Wire 125mm Pack of 10
<b>090026ART</b>	1.8mm Arthrodesis Wire 125mm Pack of 10
<b>090023ART</b>	2.0mm Arthrodesis Wire 125mm Pack of 10
<b>090025ART</b>	Pack of Mixed Arthrodesis Wires

### Arthrodesis Wire 178mm Long (Extra Long)

<b>090064ART</b>	0.9mm Arthrodesis Wire 178mm Pack of 10
<b>090065ART</b>	1.1mm Arthrodesis Wire 178mm Pack of 10
<b>090066ART</b>	1.4mm Arthrodesis Wire 178mm Pack of 10
<b>090067ART</b>	1.6mm Arthrodesis Wire 178mm Pack of 10
<b>090068ART</b>	1.8mm Arthrodesis Wire 178mm Pack of 10
<b>090069ART</b>	2.0mm Arthrodesis Wire 178mm Pack of 10

### Arthrodesis Wire Extra Fine 70mm Long

Arthrodesis Wires - Extra Fine. 70mm long with one trochar end & one blunt end. Useful for exotics. Supplied in packs of ten.

<b>090056ART</b>	0.6mm Arthrodesis Wire Trochar/B 70mm Pack of 10
<b>090055ART</b>	0.7mm Arthrodesis Wire Trochar/B 70mm Pack of 10

## Kirschner Wire 125mm Long

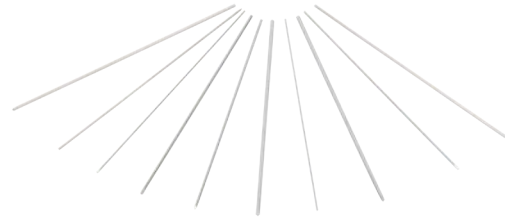

One tip bayonet, the other blunt, these Pins are supplied in packs of ten. 125mm Long.

<b>090030KIR</b>	0.9mm Kirschner Wire 125mm Pack of 10
<b>090070KIR</b>	1mm Kirschner Wire 125mm Pack of 10
<b>090031KIR</b>	1.1mm Kirschner Wire 125mm Pack of 10
<b>090071KIR</b>	1.25mm Kirschner Wire 125mm Pack of 10
<b>090034KIR</b>	1.4mm Kirschner Wire 125mm Pack of 10
<b>090072KIR</b>	1.5mm Kirschner Wire 125mm Pack of 10
<b>090032KIR</b>	1.6mm Kirschner Wire 125mm Pack of 10
<b>090073KIR</b>	1.8mm Kirschner Wire 125mm Pack of 10
<b>090033KIR</b>	2.0mm Kirschner Wire 125mm Pack of 10
<b>090030MIX</b>	Pack of Mixed Kirschner Wires

## Kirschner Wire 178mm Long (Extra Long)

One tip bayonet, the other blunt, these Pins are supplied in packs of ten. 178-180mm Long. Extra long.

<b>090074KIR</b>	0.9mm Kirschner Wire 180mm Pack of 10
<b>090075KIR</b>	1.1mm Kirschner Wire 178mm Pack of 10
<b>090076KIR</b>	1.4mm Kirschner Wire 178mm Pack of 10
<b>090077KIR</b>	1.6mm Kirschner Wire 178mm Pack of 10
<b>090078KIR</b>	1.8mm Kirschner Wire 178mm Pack of 10
<b>090079KIR</b>	2mm Kirschner Wire 178mm Pack of 10

### Threaded Pins & Wires

Threaded wires have a much greater pull out resistance than smooth wires. They are very easy to insert using standard drills fitted with Jacobs chucks or wire drivers. Although having only trochar tips they will self tap in all but the hardest of cortical bone. Driven across fragments, threaded wires act as mini position screws which can be cut off flush to the bone surface or buried. It may be possible to place several threaded wires at angles to each other in a relatively small area.

Available in coarse or fine thread pitches. Use the coarse in cancellous or metaphyseal bone.

#### Coarse Threaded Small Fragment Pins



Use threaded pins where you might use a 2mm fixation screw or K Wire, e.g. tibial crest transplant. Drive in with slow speed drill. Relatively coarse threads. 0.8mm thread pitch.

- 090036 Threaded Pins 5mm Thread Single
- 090037 Threaded Pins 10mm Thread Single
- 090027 Threaded Pins 15mm Thread Single
- 090028 Threaded Pins 20mm Thread Single

#### 1.6mm Threaded Pins with Olive

- KS1101 1.6mm Threaded Pin with Olive
- KS1102 1.6mm Threaded Pin with Olive

#### Fine Threaded Small Fragment Pins 2.0mm

Use singly to re-attach small bone fragments. Use in multiples to re-attach larger fragments e.g. humeral condyles. (4 x 2.0 threaded pins have similar properties to one 3.5 screw while interfering less with the healing process). Use threaded washer to create screw effect. Very easy to insert using an orthopaedic drill.

Thread pitch is 0.4mm for use in cortical bone. Self drilling. Cut off excess pin. For maximum pull out resistance drill through trans cortex & cut off trochar cutting tip.

- 090300 Fine Threaded Washer 5.0mm Diameter Single
- 090305 Fine Threaded Pin 5mm Thread Length Single
- 090310 Fine Threaded Pin 10mm Thread Length Single
- 090315 Fine Threaded Pin 15mm Thread Length Single
- 090320 Fine Threaded Pin 20mm Thread Length Single
- 090325 Fine Threaded Pin 25mm Thread Length Single
- 090330 Fine Threaded Pin 30mm Thread Length Single
- 090340 Fine Threaded Pin 40mm Thread Length Single

#### Fully Threaded Arthrodesis Wires

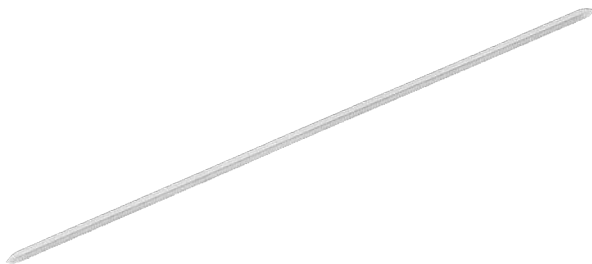

- 090093ART Fully Threaded Wire Single 1.5mm
- 090094ART Fully Threaded Wire Single 2.0mm

### Steinman Intra-Medullary Pins

Simple, cheap & often the best technique for the repair of long bones. I/M pinning does not resist compression & rotation very effectively. It may be helpful to add an external fixator for two weeks if in any doubt. Smooth pins are most likely to migrate. The threaded pins are negatively cut & do reduce backing out particularly if the distal fragment is small.

Our trochar tips are designed to cut bone but care must be exercised to avoid heat necrosis during insertion. Can be cut in half to produce cheap ESF pins.

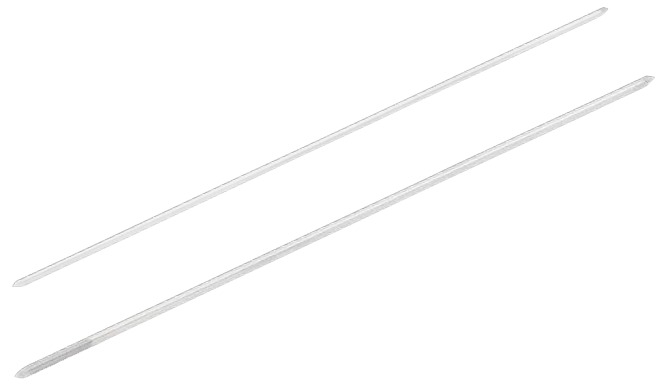

- 090000 1.6mm Bone Pin Trochar 300mm 1/16"
- 090001 2.0mm Bone Pin Trochar 300mm 5/64"
- 090002 2.4mm Bone Pin Trochar 300mm 3/32"
- 090003 2.8mm Bone Pin Trochar 300mm 7/64"
- 090004 3.2mm Bone Pin Trochar 300mm 1/8"
- 090005 3.5mm Bone Pin Trochar 300mm 9/64"
- 090006 4.0mm Bone Pin Trochar 300mm 5/32"
- 090007 4.8mm Bone Pin Trochar 300mm 3/16"
- 090153 6mm Bone Pin Trochar 300mm 1/4"
- 090008 6.35mm Bone Pin Trochar 300mm 1/4"
  
- 090010 1.6mm Bone Pin Screw End 300mm 1/16"
- 090011 2.0mm Bone Pin Screw End 300mm 5/64"
- 090012 2.4mm Bone Pin Screw End 300mm 3/32"
- 090013 2.8mm Bone Pin Screw End 300mm 7/64"
- 090014 3.2mm Bone Pin Screw End 300mm 1/8"
- 090015 3.5mm Bone Pin Screw End 300mm 9/64"
- 090016 4.0mm Bone Pin Screw End 300mm 5/32"
- 090017 4.8mm Bone Pin Screw End 300mm 3/16"
- 090154 6.0mm Bone Pin Screw End 300mm 1/4"
- 090018 6.35mm Bone Pin Screw End 300mm 1/4"



## Wire & Pin Storage Arthrodesis Wire Box

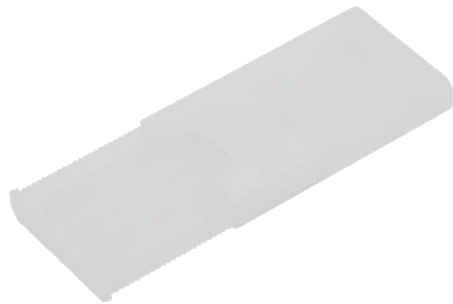

Box will store all diameters of Arthrodesis & K Wires in four compartments.

**0900200** Arthrodesis & K Wire Organiser Plastic (Autoclavable)

## A & K Wire Holders for 5"/125mm Wires



The simplest solution for storing A/ K wires is to have a tube dedicated for each size marked clearly with the diameter. There is no possibility for confusion. Each tube is 165mm long & 12mm diameter & will take any wire less than 150mm in length.

<b>0900390.8</b>	0.8mm A & K Wire Holder
<b>0900390.9</b>	0.9mm A & K Wire Holder
<b>0900391.0</b>	1.0mm A & K Wire Holder
<b>0900391.1</b>	1.1mm A & K Wire Holder
<b>0900391.2</b>	1.25mm A & K Wire Holder
<b>0900391.4</b>	1.4mm A & K Wire Holder
<b>0900391.5</b>	1.5mm A & K Wire Holder
<b>0900391.6</b>	1.6mm A & K Wire Holder
<b>0900391.8</b>	1.8mm A & K Wire Holder
<b>0900392.0</b>	2.0mm A & K Wire Holder
<b>090039SET</b>	A & K Wire Holder Set (10)

## A & K Wire Dispenser



The tube is sub-divided into four sections each of which has a window through which the wires may be viewed. The knurled dispensing tip is rotated until the hole is over the desired wire size & the wire shaken out. Total length 175mm. For wires 125mm. Marked with the standard sizes of 0.9mm, 1.1mm, 1.6mm & 2.0mm.

**090039E** A & K Wire Dispenser 0.9mm, 1.1mm, 1.6mm & 2.0mm

## Bone Pin Roll



Bone pin storage & sterilisation is difficult. Pins are long & sharp. The bone pin roll stores at least one of each pin.

An added advantage is that the pins do not penetrate sterilisation bags.

**090038** Bone Pin Roll

## Bone Pin Tubes



**090039A** I/M Pin Storage/Autoclave Tube 320mm  
**090039C** I/M Pin Storage/Autoclave Tube 255mm

## IM Pin Box



Keep all your 300mm IM Pins arranged & in size order safely within our IM pin box. The hard box will reduce the chance of personal injury & the risks of perforating packaging.

The box is fully autoclavable, but also makes an excellent stock-box. At a glance you can quickly see how many of each size pin it is holding. The box features a platform with a clearly marked metric & imperial pin gauge to make it very user friendly.

The pin sizes are, 1.6mm, 2.0mm, 2.4mm, 2.8mm, 3.2mm, 3.6mm, 4.0mm, 4.8mm & 6.35mm. Box external dimensions 308 x 138 x 64mm.

**IMPBOX01** IM Pin Box With Insert - Supplied Empty  
**IMPBOXTRO** IM Pin Box Complete With Steinman Pins Trochar Tips  
**IMPBOXSCR** IM Pin Box Complete With Steinman Pins Screw Point Tips

### Orthopaedic Wire



Cerclage wire is an extremely useful method of fragment fixation. Use as thick a wire as seems possible. Twist evenly under tension. The best instrument is our Wire Twister/Cutter 001260. Minimise wire movement on periosteum. Tension wire banding should be performed where muscular forces must be transferred beyond a fracture or osteotomy, e.g. Tibial crest avulsion or trochanteric osteotomy. 1.0mm Wire is the most useful for mid-sized dogs. All are supplied in 10 metre rolls.

- OW0210** 32g Reel of Orthopaedic Wire 0.20mm
- OW0310** 30g Reel of Orthopaedic Wire 0.30mm
- OW0410** 27g Reel of Orthopaedic Wire 0.40mm
- OW0510** 25g Reel of Orthopaedic Wire 0.5mm
- OW0610** 24g Reel of Orthopaedic Wire 0.6mm
- OW0710** 22g Reel of Orthopaedic Wire 0.71mm
- OW0810** 21g Reel of Orthopaedic Wire 0.8mm
- OW0910** 20.5g Reel of Orthopaedic Wire 0.9mm
- OW1010** 20g Reel of Orthopaedic Wire 1.0mm
- OW1012** 18g Reel of Orthopaedic Wire 1.2mm
- OW1015** 16g Reel of Orthopaedic Wire 1.5mm



**FOR CONVENIENCE & IDENTIFICATION ROLLS OF ORTHOPAEDIC WIRE CAN BE MARKED WITH PADLOCK SECURITY TAGS. THIS ALSO HAS THE ADDED ADVANTAGE OF STOPPING ROLLS OF WIRE UNRAVELING IN THE OPERATING THEATRE.**

### Orthopaedic Wire Kit



Cerclage wire can be a very useful means of fragment fixation. Kit containing our most popular cerclage instruments & a roll of wire, discounted over component price.

Kit contains:

001260	Wire Twister	x1
001256	Set of 3 Single Ended Wire Passers	x1
OW1010	10m Roll of 1.0mm Orthopaedic Wire	x1

**OWKIT** Orthopaedic Wire Kit

**Wire Passers can be found on page 25.**

### Wire Twister/Shear Cutter



- Jaws lock onto wire to enable easy twisting under tension for kink-free cerclage. The wire must be twisted under tension to create an even spiral
- Improved design, long life shear action cutter will cut 18 gauge (1.2mm) wire twisted double
- Serrated jaws grip & turn cut ends. Jaws have fenestration for extra grip
- Not designed to cut A + K wires, pins or fish hooks
- Available with Tungsten Carbide Jaws for extra grip (not fenestrated)

- 001260** Wire Twister/Shear Cutter 165mm Long
- 001261** Wire Twister/Shear Cutter - Tungsten Carbide Jaws 165mm Long

### Wires With Eyelet

The free end of the wire is threaded through the eye. The cerclage is tightened using the special tightener. Requires a device for tightening eyed wires, see 001262 & 001264

- CWWE22** Orthopaedic Wire With Eyelet 22g x 12" (6 Pack)
- CWWE20** Orthopaedic Wire With Eyelet 20g x 12" (6 Pack)
- CWWE18** Orthopaedic Wire With Eyelet 18g x 12" (6 Pack)

### Wire Tightener For Eyed Wires



Used to tension eyed wires very tightly. The cerclage is finished by kinking the wire back against the eye.

- 001262** Wire Loop Tightener 125mm Long

### Wire Tightener With Two Cranks For Double Loop Cerclage & Eyed Wire



Use with single crank for eyelet wires. Use both cranks to tighten double loops.

- 001264** Wire Tightener With Two Cranks 240mm Long

## Drill Guides & Sleeves

### Universal Drill Guides



- UDG15 – Universal Drill Guide for 1.5mm screws:**  
For load & neutral positioning of 1.1mm drills & tissue protector for 1.5mm tap
- UDG20 – Universal Drill Guide for 2.0mm screws:**  
For load & neutral positioning of 1.5mm drills & tissue protector for 2.0mm tap
- UDG24 – Universal Drill Guide for 2.4mm screws:**  
For load & neutral positioning of 1.8mm drills & tissue protector for 2.4mm tap
- UDG27 – Universal Drill Guide for 2.7mm screws:**  
For load & neutral positioning of 2.0mm drills & tissue protector for 2.7mm tap
- UDG35 – Universal Drill Guide for 3.5mm screws:**  
For load & neutral positioning of 2.5mm drills & tissue protector for 3.5mm tap

- UDG15** Universal Drill Guide For 1.5mm Screws
- UDG20** Universal Drill Guide For 2.0mm Screws
- UDG24** Universal Drill Guide For 2.4mm Screws
- UDG27** Universal Drill Guide For 2.7mm Screws
- UDG35** Universal Drill Guide For 3.5mm Screws

### Locking Screw Drill Guides



- LSDG15** Locking Screw Drill Guide For 1.5mm
- LSDG20** Locking Screw Drill Guide For 2.0mm
- LSDG2424** Locking Screw Drill Guide For 2.4mm
- LSDG2724** Locking Screw Drill Guide For 2.7mm
- LSDG35** Locking Screw Drill Guide For 3.5mm
- LSDG20XL** Locking Screw Drill Guide For 2.0mm Extra Long
- LSDG2424XL** Locking Screw Drill Guide For 2.4mm Extra Long
- LSDG2724XL** Locking Screw Drill Guide For 2.7mm Extra Long
- LSDG35XL** Locking Screw Drill Guide For 3.5mm Extra Long
- LSDG35XXL** Locking Screw Drill Guide For 3.5mm Double XL

### Locking Wire Guide



Screws into the locking plate to allow placement of a K Wire for temporary fixation of the plate to the bone. May also be used to facilitate plate manipulation during MIPO application.

- L20W11G** Locking 2.0mm Wire 1.1mm Guide
- L24W14G** Locking 2.4mm Wire 1.4mm Guide
- L27W16G** Locking 2.7mm Wire 1.6mm Guide
- L35W20G** Locking 3.5mm Wire 2.0mm Guide

### Load Neutral Drill Guides



To exert compression at the fracture site, the cortical screw must be positioned precisely within the slot in the compression plate. The Load Neutral Drill Guide has two tips, one for compression (load) & one where no compression is exerted (neutral). There is one combination for each screw/plate size. Each guide is marked with the drill size to be used.

- LNDG15** Load Neutral Drill Guide For 1.5mm Compression Plates
- LNDG20** Load Neutral Drill Guide For 2.0mm Compression Plates
- LNDG24** Load Neutral Drill Guide For 2.4mm Compression Plates
- LNDG27** Load Neutral Drill Guide For 2.7mm Compression Plates
- LNDG35** Load Neutral Drill Guide For 3.5mm Compression Plates
- LNDG45** Load Neutral Drill Guide For 4.5mm Compression Plates

### Insert Sleeves



Insert Sleeves centre smaller drills in the placement of lag screws.

- SL2015** Insert Sleeve 2.0mm o/d 1.5mm i/d
- SL2418** Insert Sleeve 2.4mm o/d 1.8mm i/d
- SL2720** Insert Sleeve 2.7mm o/d 2.0mm i/d
- SL3520** Insert Sleeve 3.5mm o/d 2.0mm i/d
- SL3525** Insert Sleeve 3.5mm o/d 2.5mm i/d
- SL3527** Insert Sleeve 3.5mm o/d 2.7mm i/d
- SL4532** Insert Sleeve 4.5mm o/d 3.2mm i/d
- SL5540** Insert Sleeve 5.5mm o/d 4.0mm i/d
- SL6545** Insert Sleeve 6.5mm o/d 4.5mm i/d

### Tissue Protection Sleeves



Rotating pins, drills & taps will "pick up" soft tissues, skin, muscle, nerve & blood vessels, causing serious damage. Use of tissue protection sleeves minimises such damage. The teeth at the top of the guide locate on the bone whilst the stainless tube provides a barrier between soft tissue & implant equipment.

- TP2020** For Drill/Taps To 2.0mm 90mm
- TP0024** For Drill/Taps To 2.4mm 90mm
- TP0027** For Drill/Taps To 2.7mm 90mm
- TP0035** For Drill/Taps To 3.5mm 90mm
- TP0045** For Drill/Taps To 4.5mm 90mm

### Drill Guide 0.7/1.0mm



Due to the size limitations, this device serves only as a drill guide & cannot be used as an insert sleeve or tap guide.

**CDTIS10** Drill Guide 0.7mm/1.0mm

### Adjustable Drill Guide



Our Adjustable Drill Guide allows accurate placement of drill holes by predetermination of drill entry & exit points. Locks onto bone to minimise errors.

- The swivelling point allows use of the guide where access is limited
- Supplied with 2.0, 2.5 & 3.5 Drill Sleeves. Use the appropriate sleeve for the drill in use
- A scale on the instrument measures hole depth
- Applications include condyle fractures, femoral neck tunnels, screw holes, & ununited anconeal process

In our view this design has significant advantages over CEG & C guides

**ADJDG2035** Adjustable Drill Guide For 2.0mm/2.5mm/3.5mm Drills 175mm  
**KWG10** K-wire Guide For ADJDG2035  
**ADJDG45** Adjustable Drill Guide 4.5mm Drills 190mm

### C Drill Guide



Use of an appropriate sized drill guide enables the surgeon to control exactly the entry & exit points of drills. This ability is extremely important in lag screwing.

Various insert sleeves are available for each drill size, with an accurate guidance system, & provide exact positioning of holes for lag screwing, (e.g. for a 3.5mm cortical screw, drill 3.5 lag hole in proximal cortex, insert SL3525 & drill through it into the trans cortex. Finally tap & insert screw).

**CEG2735** Small Drill Guide i/d 3.5mm 'C' Guide 135mm

### Triple Drill Guides



Triple Drill Guides are used to accurately position drills & K or arthrodesis wires. The three holes in the head allow for the placement of parallel anti-rotation wires.

**SLG1115** Double Drill Guide/Sleeve For 1.1mm & 1.5mm Drills 100mm  
**SLG0020** Triple Drill Guide/Sleeve For 2.0mm Drills 115mm  
**SLG0025** Triple Drill Guide/Sleeve For 2.5mm Drills 115mm

### Self-Centring Drill Guides



Whether it be for external fixation or screw application, it is desirable for implants to be positioned fairly centrally into bones. Sized for the most popular drill-bits, these devices will help achieve accurate positioning of pilot holes.

**CDG11** Self-Centring Drill-Guide For 1.1mm Drill 10mm Spread  
**CDG15** Self-Centring Drill-Guide For 1.5mm Drill 12mm Spread  
**CDG20** Self-Centring Drill-Guide For 2.0mm Drill 14mm Spread  
**CDG25** Self-Centring Drill-Guide For 2.5mm Drill 18mm Spread  
**CDG32** Self-Centring Drill-Guide For 3.2mm Drill 23mm Spread

### Combination Drill, Tap & Insert Sleeve



The large end has an internal diameter which matches the clearance drill & tap. The small end has an internal diameter the same as the pilot drill & an external diameter which fits the clearance drill hole, i.e. the same as an insert sleeve. This single instrument contains all the guides & sleeves you need to place a lag screw.

**CDTIS20** Combination Drill, Tap & Insert Sleeve for 2.0 Screws 100mm  
**CDTIS24** Combination Drill, Tap & Insert Sleeve for 2.4 Screws 105mm  
**CDTIS27** Combination Drill, Tap & Insert Sleeve for 2.7 Screws 110mm  
**CDTIS35** Combination Drill, Tap & Insert Sleeve for 3.5 Screws 115mm  
**CDTIS45** Combination Drill, Tap & Insert Sleeve for 4.5 Screws 130mm

## Depth Gauges



Accurate measurement of hole depth is essential in order to select the appropriate screw size.

A range of gauges are available for various screw sizes. Hole depth is read from the instrument. Add extra to the measured length to ensure maximal screw thread/bone interface engagement.

Chart supplied with depth gauge or available on request. Use in self-tapping or cortical systems.

- DG2027** Depth Gauge For 2.0mm & 2.7mm Screws 135mm
- DG242735** Depth Gauge For 2.4mm, 2.7mm & 3.5mm Screws 180mm (TTA only)
- DG2735** Depth Gauge For 2.7mm & 3.5mm Screws 175mm
- DG4565** Depth Gauge For 4.5mm & 6.5mm Screws 290mm

## Premium Depth Gauge



Radius matches screw under-head to replicate screw position. Improved hook. Contoured comfortable grip for ease of use. Store in fully retracted state to protect the delicate probe section.

- DGP15** Premium Depth Gauge For 1.5mm Screws
- DGP2024** Premium Depth Gauge For 2.0/2.4mm Screws
- DGP2735** Premium Depth Gauge For 2.7/3.5mm Screws

## Bone Plate Contouring Bone Plate Bending Levers



Bone plates appropriate for the repair of load bearing long bones are very stiff. Accurate contouring of plates is essential for precise fracture reduction; however marking of plates during the bending process will lead to reduced fatigue strength.

Contoured plates should be placed with adequate support to minimise cyclical loading.

Extra length benders 01288L are particularly useful for contouring larger TPLO plates along with 3.5mm & 4.5mm standard plates.

Bone plate benders used in pairs are the most economic method of plate contouring. Supplied in pairs.

- 001280** 1.0mm Bending Levers 130mm Long
- 001286** AO Type 1.5mm/2.0mm Bending Levers 130mm Long
- 001285** AO Type 2.4mm Bending Levers 140mm Long
- 001287** AO Type 2.7mm/3.5mm Bending Levers 175mm Long
- 001288** AO Type 3.5mm/4.5mm Broad Bending Levers 200mm Long
- 001288L** 3.5/4.5 Extra Long Bending Levers 240mm Long

## Delta TPLO Plate Benders With Curved Slots



Plate benders with slots tend to distort the Delta plate.

The curved slots help grip & support the plate during the bending process. In addition the plate is much less likely to end up on the floor.

- TPLODELBEND** Delta TPLO Plate Benders (Pair) 230mm Long

## Reconstruction Plate Pliers



- 001284A** Reconstruction Plate Pliers For 2.7mm Plates 280mm Long
- 001284** Reconstruction Plate Pliers For 3.5mm Plates 290mm Long

**Plate Bending Pliers - Roller Type**



- 001283SMALL** Plate Bending Pliers Roller Type 230mm Long Suitable For 3.5mm Plates
- 001283** Plate Bending Pliers Roller Type 380mm Long Suitable For 3.5mm & 4.5mm Plates

**Bone Plate Press**



- 001281** Bone Plate Press Small 285mm Long For Plates Up To & Including 4.5mm Narrow
- 001282** Bone Plate Press Large 410mm Long For All Plates

**Tips on the use of the Plate Press**

- The press works at maximum efficiency when the handle is approx. parallel with the base. Make sure the press is on a stable firm surface
- Place the plate to be contoured in between the anvils
- Adjust the gap between the anvils using the screw until the handle is parallel with the base
- Pressure on the handle will bend the plate
- Readjust the press using the screw to bring the handle parallel once again
- Contouring the plate should be accomplished using several small adjustments rather than one big one

Please check the press selected will fit your autoclave before purchase.

**AO Type Plate Bending Pliers**



These pliers will contour 2.7mm & 3.5mm narrow plates. 3.5mm DCP's will require multiple small bends. Also useful for bending guide pins in the Slocum TPLO technique.

- 001289B** AO Plate Bending Pliers 2.7mm/3.5mm

**Heavy Duty Bone Plate Pliers To 4.5mm**



The largest bone plate pliers in the range, these will contour all plates other than the 4.5mm broad.

The bending head has 3 interchangeable anvils & the 'hammer' side has 3 different shapes which rotate. This offers the surgeon 6 different contouring options to match different plates & different shapes.

- 001289C** Heavy Duty Plate Bending Pliers
- 001289SA** Small Anvil For 2.7mm Plates (For Existing Users)

**Bending Templates**

To avoid repeated entry into the operation site when contouring plates, an aluminium bending template is contoured to the bone. The steel plate is then bent to match the template using irons or a bone plate press.

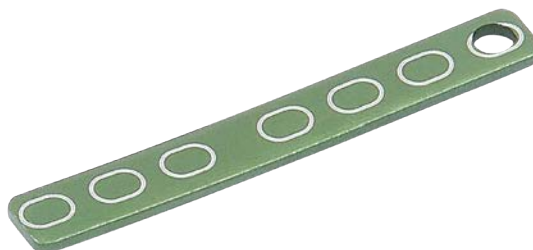

- BT200737** Bending Template 37mm For 2.0mm DCPs & Round Hole Plates
- BT240752** Bending Template 52mm For 2.4mm DCPs & Round Hole Plates
- BT270760** Bending Template 60mm For 2.7mm DCPs & Round Hole Plates
- BT350786** Bending Template 86mm For 3.5mm DCPs & Round Hole Plates
- BT4507120** Bending Template 120mm For 4.5mm DCPs & Broad 3.5mm DCPs & HD & Round Hole Plates
- BT152700** Bending Template For 2.0mm Supracondylar Plate
- BT152711** Bending Template For 2.4mm Supracondylar Plate
- BT152714** Bending Template For 2.7mm Supracondylar Plate
- BT152717** Bending Template For 3.5mm Supracondylar Plate

## Whiting Bone Plate Retractor



Developed by Colin Whiting the bone plate retractor is designed to expose the end hole(s) of the plate for screw placement.

It is often the case that a plate is pushed under soft tissues to avoid unnecessarily large exposures only to find that it is very difficult to access the last screw hole. The bone plate lever slides along the plate until the tip drops over the end. The handle is then elevated & the tip of the lever hooks onto the end of the plate. As the retractor is lifted the end hole of the plate is exposed allowing free insertion of drills taps & screws.

**BPR3535** Whiting Bone Plate Retractor 3.5/3.5mm Broad

## Screw Holding Forceps



A useful instrument for selecting screws with minimal handling. Can be used with any style of screw.

**SF1024** Screw Holding Forceps 1.0/1.5/2.0/2.4mm Screws  
**SF2055** Screw Holding Forceps 2.4/2.7/3.5/4.5mm Screws

## Plate Holding Clip



A useful little clip for holding plates in sequence. Labelled with size.

**BPC2** Plate Holding Clip 2.0mm  
**BPC24** Plate Holding Clip 2.4mm  
**BPC27** Plate Holding Clip 2.7mm  
**BPC35** Plate Holding Clip 3.5mm

## Webb Bolts



Use where a lag screw strips out. Supplied as a threaded rod, two nuts & two washers.

Pre-measure & cut to length or crop after procedure. Saw cut or bolt cutting will prevent loosening of the nut on the cut side.

Run a fine nylon suture through the nut prior to attachment to create a locking effect.

5mm Webb Bolt use 5.5mm Drill H090109S. Requires 8mm spanner (001565).

4mm Webb Bolt use 4.0mm Drill H090107S. Requires 7mm spanner (001566).

3mm Webb Bolt use 3.2mm Drill H090105S. Requires 5.5mm spanner.

2mm Webb Bolt use 2.0mm Drill H090102. Requires 4mm spanner.

**092003** Webb Bolt 5mm/8cm  
**092000** Webb Bolt 4mm/8cm  
**092001** Webb Bolt 3mm/8cm  
**092002** Webb Bolt 2mm/5cm

## Washers



Use to spread load or retain wire or sutures. Use with cortical or self tapping screws. Spikey washers are used to reattach ligaments.

**PW15** Plain Washer 1.5mm Screws Stainless  
**PW20** Plain Washer 2.0mm/1.5mm Screws Stainless  
**PW20B** Plain Washer 2.0mm Screws Broad 6mm Diameter  
**PW24** Plain Washer 2.4mm Screws Stainless  
**PW24TI** Plain Washer 2.4mm Screws Titanium  
**PW273540** Plain Washer 2.7mm/3.5/4.0mm Screws Stainless 7.0mm Dia  
**PW273540B** Plain Washer 2.7mm/3.5mm/4.0mm Screws Stainless 8.5mm Dia  
**PW45** Plain Washer 4.5mm Screws Stainless  
**SW15** Spikey Washer 1.5mm Screws Stainless  
**SW20** Spikey Washer 2.0mm Screws Stainless  
**SW27** Spikey Washer 2.7mm Screws Stainless  
**SW3540** Spikey Washer 3.5mm/4.0mm Screws Stainless  
**SW45** Spikey Washer 4.5mm Screws Stainless

## Cerclage Button



**CB15** Cerclage Button For 1.5 DCP  
**CB20** Cerclage Button For 2 DCP  
**CB24** Cerclage Button For 2.4 DCP  
**CB27** Cerclage Button For 2.7 DCP  
**CB35** Cerclage Button For 3.5 DCP

### Cortical Nuts



Occasionally tapped threads strip & a larger screw is appropriate. Lag screws are particularly vulnerable as only one cortex is available.

A cortical nut manufactured from implant grade nylon gives the screw purchase allowing normal tightening. The thread form is designed to grip the screw to minimise 'backing out'.

Available in 2.0mm, 2.4mm, 2.7mm, 3.5mm & 4.5mm cortical thread forms. Supplied as a single sterile pack. The cortical nuts are also available in stainless steel.

- N20** 2.0mm Cortical Nut Stainless Steel (Non Sterile)
- N24** 2.4mm Cortical Nut Stainless Steel (Non Sterile)
- N27** 2.7mm Cortical Nut Stainless Steel (Non Sterile)
- N35** 3.5mm Cortical Nut Stainless Steel (Non Sterile)
- N45** 4.5mm Cortical Nut Stainless Steel (Non Sterile)
- CN20-A** 2.0mm Cortical Nut Nylon (Sterile)
- CN24-A** 2.4mm Cortical Nut Nylon (Sterile)
- CN27-A** 2.7mm Cortical Nut Nylon (Sterile)
- CN35-A** 3.5mm Cortical Nut Nylon (Sterile)
- CN45-A** 4.5mm Cortical Nut Nylon (Sterile)

Cortical Nut	Nut Profile	Associated Spanner Size
N20	Square	3.5mm
N24	Square	4.5mm
N27	Hex	1/4"
N35	Hex	7mm
N45	Hex	11/42"

### Screw Extraction Trepine



Once the head of a screw has become detached the shaft can be very difficult to extract, particularly when the screw has been in situ for some time. The screw extraction trephine is designed to 'core out' the screw shaft either in its entirety or partially to allow the screw to be grasped by extraction forceps. The internal diameter is a little larger than the screw to be extracted. The external diameter is small enough in most cases to allow the replacement of the screw by a larger one. The trephine fits directly into a Jacobs Chuck.

- SCET20** Extraction Trephine For 2.0mm Screws o/d 2.7mm
- SCET24** Extraction Trephine For 2.4mm Screws o/d 3.5mm
- SCET27** Extraction Trephine For 2.7mm Screws o/d 3.5mm
- SCET35** Extraction Trephine For 3.5mm Screws o/d 4.5mm
- SCET45** Extraction Trephine For 4.5mm Screws o/d 5.5mm

### Equipment & Screw Boxes AO Screw/Equipment Boxes



BX20CS

BX2735CS

Please note design may vary with size of implant

- BX20CS** Box For 2.0mm AO Screws & Equipment
- BX24CS** Box For 2.4mm AO Screws & Equipment
- BX2735CS** Box For 2.7mm/3.5mm AO Screws & Equipment

### Screw Boxes For AO Type Screws &/Or Locking Screws



Please note design may vary with size of implant

- SH1500** Screw Box 1.5mm AO Type Screws &/Or Locking Screws (All Lengths)
- SH2000** Screw Box 2.0mm AO Type Screws &/Or Locking Screws (All Lengths)
- SH2400** Screw Box 2.4mm AO Type Screws &/Or Locking Screws (All Lengths)
- SH2700** Screw Box 2.7mm AO Type Screws &/Or Locking Screws (All Lengths)
- SH2735** Screw Box 2.7mm & 3.5mm AO Type Screws &/Or Locking Screws (All Lengths of 2.7mm & All Lengths Of 3.5mm Up To 50mm)
- SH3500** Screw Box 3.5mm AO Type Screws &/Or Locking Screws (Up To 50mm)
- SH4500** Screw Box For 4.5mm AO Type Screws (Even Number Lengths From 12-50mm)



# External Fixation



To view the External Fixation section of our website, please scan the QR code:



## ESF Pins

### Positive Threaded Pins

Positive threaded pins are the pin of choice for ESF application as they have excellent resistance to pull-out, & no inherent point of weakness.

End threaded pins are used as half pins (type IA & IB ESF frames), & centre threaded pins as full pins (type II frames).

### Positive Threaded Pins - Cortical

End Thread



The fine threads of these pins are proud of the shank eliminating the weak point where the thread ends in other pins.

The major benefit of positive threaded pins is that the additional thread diameter creates a larger bone pin interface for a given shaft diameter.

This style of pin is useful where a good pull out resistance is required & where it is anticipated that the frames will be left in situ for long periods - 6 weeks plus.

- CET0014** 0.8mm Shank 1.1mm Threads 60mm Long - End Thread
- CET0013** 1.0mm Shank 1.3mm Threads 65mm Long - End Thread
- CET0015** 1.2mm Shank 1.5mm Threads 65mm Long - End Thread
- CET0016** 1.2mm Shank 1.6mm Threads 70mm Long - End Thread
- CET0017** 1.4mm Shank 1.8mm Threads 70mm Long - End Thread
- CET0018** 1.6mm Shank 2.0mm Threads 70mm Long - End Thread
- CET0026** 1.8mm Shank 2.2mm Threads 80mm Long - End Thread
- CET0019** 2.0mm Shank 2.4mm Threads 85mm Long - End Thread
- CET0020** 2.4mm Shank 3.2mm Threads 100mm Long - End Thread
- CET0020A** 2.7mm Shank 3.5mm Threads 110mm Long - End Thread
- CET0020B** 3.0mm Shank 3.8mm Threads 120mm Long - End Thread
- CET0021** 3.2mm Shank 4.0mm Threads 130mm Long - End Thread
- CET0024A** 3.5mm Shank 4.3mm Threads 130mm Long - End Thread
- CET0022** 4.0mm Shank 4.8mm Threads 150mm Long - End Thread

Mid Thread



The Mid Threaded Pin provides good pull out resistance in frames where the fixation pins are supported on either side of the limb by connecting bars. i.e. Type II frames.

- CMT0013** 0.8mm Shank 1.1mm Threads 85mm Long - Mid Thread
- CMT0014** 1.1mm Shank 1.4mm Threads 85mm Long - Mid Thread
- CMT0015** 1.2mm Shank 1.5mm Threads 85mm Long - Mid Thread
- CMT0016** 1.4mm Shank 1.8mm Threads 85mm Long - Mid Thread
- CMT0017** 1.6mm Shank 2.0mm Threads 85mm Long - Mid Thread\*
- CMT0018** 1.6mm Shank 2.0mm Threads 85mm Long - Mid Thread\*\*
- CMT0018A** 1.8mm Shank 2.2mm Threads 90mm Long - Mid Thread
- CMT0019** 2.0mm Shank 2.4mm Threads 105mm Long - Mid Thread
- CMT0019A** 2.2mm Shank 2.6mm Threads 105mm Long - Mid Thread
- CMT0023** 2.4mm Shank 3.2mm Threads 105mm Long - Mid Thread
- CMT0023A** 2.7mm Shank 3.5mm Threads 115mm Long - Mid Thread
- CMT0023B** 3.0mm Shank 3.8mm Threads 120mm Long - Mid Thread
- CMT0024** 3.2mm Shank 4.0mm Threads 130mm Long - Mid Thread
- CMT0024A** 3.5mm Shank 4.3mm Threads 140mm Long - Mid Thread
- CMT0025** 4.0mm Shank 4.8mm Threads 150mm Long - Mid Thread

\*CMT0017 has a 16mm thread length.

\*\*CMT0018 has a 20mm thread length.

### Positive Threaded Pins – Cancellous



The coarser threads of these pins are appropriate for use in metaphyseal bone.

- CANET0026** 2.4mm Shank 3.5mm Threads 115mm Long Cancellous End Thread
- CANET0027** 3.2mm Shank 4.8mm Threads 150mm Long Cancellous End Thread
- CANMT0029** 2.4mm Shank 3.5mm Threads 150mm Long Cancellous Mid Thread
- CANMT0030** 3.2mm Shank 4.8mm Threads 180mm Long Cancellous Mid Thread

### Trochar Pins



The smooth shanks of trochar pins provide minimal pull out resistance, there is therefore little advantage to their use. When used, trochar pins should be placed at diverging angles to maximise pull-out resistance. 130mm long.

- 001556** Trochar Pin 2mm
- 001557** Trochar Pin 3mm
- 001558** Trochar Pin 4mm

### Cortical Negative Threaded Pins (Ellis Type)



The short fine negative thread engages the trans (far)cortex & the smooth shank engages the cis (near) cortex.

The thread/shank junction (the weakest part of the pin) is positioned in the medullary cavity & protected from potential failure.

Ellis type pins have better pull out resistance over Trochar pins & the angle of placement is not as critical.

		Pin Diameter	Overall Length
<b>001528</b>	Ellis Pin	1.1mm	76mm
<b>001529</b>	Ellis Pin	1.6mm	85mm
<b>001533</b>	Ellis Pin	1.8mm	127mm
<b>001550</b>	Ellis Pin	2.0mm	127mm
<b>001530</b>	Ellis Pin	2.4mm - (3/32")	127mm
<b>001550A</b>	Ellis Pin	2.7mm - (7/64")	127mm
<b>001551</b>	Ellis Pin	3.0mm	127mm
<b>001531</b>	Ellis Pin	3.2mm - (1/8")	127mm
<b>001551A</b>	Ellis Pin	3.5mm	127mm
<b>001552</b>	Ellis Pin	4.0mm	127mm

## Bicortical Negative Threaded Pins



Bicortical Negative Pins have had a bad reputation for early failure at the thread pin junction. Where selection of pin & frame are appropriate, failure of negative threaded pins is rare.

The important criterion is thread diameter not shaft diameter. For any given thread diameter both positive & negative threaded pins are equally strong.

	Shaft Diameter	Thread Diameter	Thread Length	Overall Length
<b>BCNET08</b>	0.8mm	0.8mm	8mm	70mm
<b>BCNET10</b>	1.0mm	1.0mm	10mm	70mm
<b>BCNET11</b>	1.1mm	1.1mm	12mm	70mm
<b>BCNET13</b>	1.3mm	1.3mm	12mm	70mm
<b>BCNET15</b>	1.5mm	1.5mm	12mm	70mm
<b>BCNET16</b>	1.6mm	1.6mm	20mm	70mm
<b>BCNET18</b>	1.8mm	1.8mm	24mm	85mm
<b>BCNET20</b>	2.0mm	2.0mm	24mm	85mm
<b>BCNET24</b>	2.4mm	2.4mm	25mm	100mm
<b>BCNET27</b>	2.7mm	2.7mm	30mm	110mm
<b>BCNET30</b>	3.0mm	3.0mm	35mm	130mm
<b>BCNET35</b>	3.5mm	3.5mm	40mm	130mm
<b>BCNET40</b>	4.0mm	4.0mm	45mm	150mm
<b>BCNET50</b>	5.0mm	5.0mm	50mm	150mm

## Safety Cutter Surgical Finish To 4mm Capacity



Safety implant cutter which leaves a smoother cut end than a conventional cutter. Very useful for external fixation pins. Cut end is temporarily retained within the head rather than flying off.

Maximum capacity 4mm. Cuts 5mm below the face of the cutter.

Telescopic handles reduce the overall length from 470mm to 340mm to fit most autoclaves. Head strips for cleaning.

**001229** Safety Cutter Stainless Steel Cuts To 4.0mm Capacity 340mm Long

## Pre-Drilling ESF Pin Tracts



Pre-drilling a pin tract hole in the bone into which the ESF pin is subsequently inserted is very important as the ESF pins do not have drilling ends. Insertion of an ESF pin directly into the bone may cause impaction, micro-fracturing of the bone & excessive heat production with bone necrosis, all of which can lead to pin loosening. A drill bit that is about 10% smaller than the shank (core) diameter of the pin, or at least 0.1mm smaller should be used. A slow speed (electric) drill at about 150rpm is advisable, using flush to cool the pin & minimise heat generated in the bone that could cause bone necrosis & pin loosening. An appropriate drill guide is used to protect the soft tissues & minimise drill wobble & skidding. Once the hole is drilled, a K-wire can be used to maintain the pin tract (before the drill guide is removed) so it can be easily re-identified once the ESF pin is ready to be inserted.

<b>H090202</b>	1.9mm Pre-Drill For 2.0mm Shank Positive Pin
<b>H090203</b>	2.3mm Pre-Drill For 2.4mm Shank Positive Pin
<b>H090205</b>	3.0mm Pre-Drill For 3.2mm Shank Positive Pin
<b>H090207</b>	3.8mm Pre-Drill For 4.0mm Shank Positive Pin
<b>H090101</b>	1.5mm Pre-Drill For 2.0mm Shank Negative Pin
<b>H090102</b>	2.0mm Pre-Drill For 2.4mm Shank Negative Pin
<b>H090104</b>	2.7mm Pre-Drill For 3.2mm Shank Negative Pin
<b>H090106L</b>	3.5mm Pre-Drill For 4.0mm Shank Negative Pin

## ESF Tissue Protector



Protection of soft tissue is very important when placing an ESF frame. Protection prevents tissues from getting wrapped around the drill bit, & helps to maintain access to the pin tract in the bone.

Once a connecting bar with clamps is in position, pin placement through a drill guide presents a specific problem because standard drill guide tissue protectors cannot be removed once the pin is in position.

The ESF Tissue Protector splits along its length to allow removal. The tip has small serrations to encourage grip on the bone surface.

**001548** ESF Tissue Protector

### Standard Fixators (SF)



001740	Mini Single Clamps	x8	H090202	Hard Drill 1.9mm Pre-Drill For 2.0mm Shank Pins	x1
001741	Small Single Clamps	x8			
001742	Large Single Clamps	x8	H090112	2.5mm Round Shank Drill Hard 115mm	x1
CET0019	2.0/2.4 End Threaded Pins 85mm Long	x4	H090105S	3.2mm Round Shank Drill Hard 130mm	x1
CMT0019	2.0/2.4 Mid Threaded Pins 105mm Long	x2	001566	Small Spanner 7mm	x1
CET0020A	2.7/3.5 End Threaded Pins 110mm Long	x4	001565	Medium Spanner 8mm	x1
CMT0023A	2.7/3.5 Mid Threaded Pins 115mm Long	x2	001564	Large Spanner 10mm	x1
CET0024A	3.5/4.3 Positive End Thread 130mm Long	x4	001548	External Fixation Tissue Protector	x1
CMT0024A	3.5/4.3 Mid Threaded Pins 140mm Long	x2	001578	Stainless ESF Box With Partitions	x1
001560	Small KE & Mini SF 1/8" Connecting Bar 150mm Long	x2	001864C	Carbon Fibre Bar 6.3mm x 200mm	x2
			001872C	Large 3/8 (9.5mm) Bar x 200mm - Carbon	x2

**0017695SC** SF Full Kit With Steel/Carbon Bars

### SF Clamps



The Standard Fixator is the most adaptable standard linear ESF fixation system & is the recommended system to use. The ESF clamp design is a 2 part, 2 bolt mechanism body which can be dismantled. This means that ESF clamps can easily be added or removed from an ESF frame at any time, & by using two rather than one bolt to secure the clamp, better stability of the clamp-connecting bar & clamp-ESF pin interface is achieved.

The system is available in three different sizes, Mini, Small, & Large, as shown in the table below.

Clamp	Pin Shaft Dia	Bar Dia	Spanner
Mini	0.9mm - 2.5mm	3.2mm	7mm (001566)
Small	2.0mm - 3.2mm	6.3mm	8mm (001565)
Large	3.2mm - 4.8mm	9.5mm	10mm (001564)

### SF Bars



Connecting bars for the mini system are 3.2mm stainless steel. The Small system has carbon fibre & titanium 6.3mm connecting bars, & the Large system has 9.5mm carbon fibre & aluminium connecting bars. Carbon fibre is radiolucent meaning that the connecting bar does not obscure the image when a radiograph is taken. Considering bending strength, Titanium is stiffer than carbon fibre which in turn is stiffer than aluminium.

### SF Mini Range

- 001740** Mini Single Clamp
- 001743** Mini Double Clamp
- 001595** Mini 1/8" (3.2mm) Bar x 30mm Stainless Steel
- 001559** Mini 1/8" (3.2mm) Bar x 50mm Stainless Steel
- 001590** Mini 1/8" (3.2mm) Bar x 75mm Stainless Steel
- 001596** Mini 1/8" (3.2mm) Bar x 100mm Stainless Steel
- 001573** Mini 1/8" (3.2mm) Bar x 125mm Stainless Steel
- 001560** Mini 1/8" (3.2mm) Bar x 150mm Stainless Steel
- 001574** Mini 1/8" (3.2mm) Bar x 175mm Stainless Steel
- 001575** Mini 1/8" (3.2mm) Bar x 200mm Stainless Steel
- SL2015** Insert Drill Sleeve 2.0mm O/D 1.5mm I/D
- SL2418** Insert Drill Sleeve 2.4mm O/D 1.8mm I/D
- 001566** Spanner 7mm

### SF Small Range

- 001741** Small Single Clamp
- 001744-A** Small Double Clamp
- 001862C** Small 1/4"(6.3mm) Bar x 100mm Carbon
- 001863C** Small 1/4"(6.3mm) Bar x 150mm Carbon
- 001864C** Small 1/4"(6.3mm) Bar x 200mm Carbon
- 001865C** Small 1/4"(6.3mm) Bar x 250mm Carbon
- 001866C** Small 1/4"(6.3mm) Bar x 300mm Carbon
- 001862TI** Small 1/4"(6.3mm) Bar x 100mm Ti
- 001863TI** Small 1/4"(6.3mm) Bar x 150mm Ti
- 001864TI** Small 1/4"(6.3mm) Bar x 200mm Ti
- 001865TI** Small 1/4"(6.3mm) Bar x 250mm Ti
- SL3525** Insert Drill Sleeve 3.5mm o/d 2.5mm I/D
- 001565** Spanner 8mm

### SF Large Range

- 001742** Large Single Clamp
- 001745** Large Double Clamp
- 001870C** Large 3/8"(9.5mm) Bar x 100mm Carbon
- 001871C** Large 3/8"(9.5mm) Bar x 150mm Carbon
- 001872C** Large 3/8"(9.5mm) Bar x 200mm Carbon
- 001873C** Large 3/8"(9.5mm) Bar x 250mm Carbon
- 001874C** Large 3/8"(9.5mm) Bar x 300mm Carbon
- 001870TI** Large 3/8"(9.5mm) Bar x 100mm Aluminium
- 001871TI** Large 3/8"(9.5mm) Bar x 150mm Aluminium
- 001872TI** Large 3/8"(9.5mm) Bar x 200mm Aluminium
- 001873TI** Large 3/8"(9.5mm) Bar x 250mm Aluminium
- 001874TI** Large 3/8"(9.5mm) Bar x 300mm Aluminium
- SL4532** Insert Drill Sleeve 4.5mm O/D 3.2mm I/D
- 001564** Spanner 10mm

## KE Plus

The KE Plus linear ESF system is an evolution of the original KE system. Although it is a versatile system that has functioned well over time, it has no advantage over the SF system.

The KE Plus clamp is designed to allow a wider range of positive threaded pins to be used than the original KE clamp, but clamp stability & security is not as good as the SF system.

KE Plus is compatible with existing KE systems & is a useful addition to expand the range of the KE system. KE Plus clamps have a matt finish compared with the polished standard KE clamps. The KE Plus system is available in small, medium & large sizes.

One important limitation of the KE Plus system is that once the fixator has been applied to the patient, additional clamps cannot be added or removed from the connecting bar without removing the entire fixator, disassembling, & starting from the beginning. This is because the clamps cannot pass those already present on the connecting bar.

## Boxed KE+ ESF Kits



### 001579ND Kit List:

001525	Large Single KE Plus Clamp	x8
001526	Medium Single KE Plus Clamp	x8
001527	Small Single KE Plus Clamp	x8
001560	Small KE & Mini SF 1/8" Connecting Bar 150mm Long	x2
001564	Large Spanner 10mm	x1
001565	Medium Spanner 8mm	x1
001566	Small Spanner 7mm	x1
001578	Stainless ESF Box With Partitions	x1
001585	Large 5/16" Connecting Bar 240mm Long	x2
001589	Medium 3/16" Connecting Bar 200mm Long	x2
001548	External Fixation Tissue Protector	x1

### 001579NDP Kit List:

H090203	Hard Drill 2.3mm Pre-Drill For 2.4mm Shank Pins 125mm	x1
H090205	Hard Drill 3mm Pre-Drill For 3.2mm Shank Pins	x1
H090207	Hard Drill 3.8mm Pre-Drill For 4mm Shank Pins	x1
001525	Small Single KE Plus Clamp	x8
001526	Medium Single KE Plus Clamp	x8
001527	Large Single KE Plus Clamp	x8
001560	Small KE & Mini SF 1/8" Connecting Bar 150mm Long	x2
001564	Large Spanner 10mm	x1
001565	Medium Spanner 8mm	x1
001566	Small Spanner 7mm	x1
001578	Stainless ESF Box With Partitions	x1
001585	Large 5/16" Connecting Bar 240mm Long	x2
001589	Medium 3/16" Connecting Bar 200mm Long	x2
001548	External Fixator Tissue Protector	x1
CET0020	Positive End Thread Pin 2.4mm Shank 3.2mm Thread 100mm Long	x4
CET0021	Positive End Thread Pin 3.2mm Shank 4.9mm Thread 130mm Long	x4
CET0022	Positive End Thread Pin 4mm Shank 4.8mm Thread 150mm Long	x4
CMT0023	Positive Mid Thread Pin 2.4mm Shank 3.2mm Thread 105mm Long	x2
CMT0024	Positive Mid Thread Pin 3.2mm Shank 4mm Thread 130mm Long	x2
CMT0025	Positive Mid Thread Pin 4mm Shank 4.8mm Thread 150mm Long	x2

**001579ND** Boxed Full KE Plus Kit (No Double Clamps, Pins or Drills)  
**001579NDP** Full KE Plus Kit In Stainless Steel Box (Includes Pins and Drills, No Double Clamps)

## Single KE Plus Clamp



Medium KE Plus with large positive pin



Medium KE Plus with small positive pin

## Double Clamps



Used to attach a connecting bar to another connecting bar.

## Connecting Bars

Connecting Bars are available in 5/16" (8mm) for large clamps, 3/16" (4.8mm) for medium clamps & 1/8" (3.2mm) for small clamps.

The thicker the bar, the stronger the frame. The shorter the bar between bone fragments, the stronger the frame. Rigidity is important early in fracture healing.

When significant callus is present, it is often helpful to introduce some slight axial motion by either removing some pins or moving the clamps further away from the bone. This is known as staging down or dynamising.

Bars are available in a variety of lengths.

## KE Plus Small Range

<b>001527</b>	Small Single KE Plus Clamp
<b>001594</b>	Small Double Clamp
<b>001595</b>	Small Connecting Bar 1/8" (3.2mm) x 30mm
<b>001559</b>	Small Connecting Bar 1/8" (3.2mm) x 50mm
<b>001590</b>	Small Connecting Bar 1/8" (3.2mm) x 75mm
<b>001596</b>	Small Connecting Bar 1/8" (3.2mm) x 100mm
<b>001573</b>	Small Connecting Bar 1/8" (3.2mm) x 125mm
<b>001560</b>	Small Connecting Bar 1/8" (3.2mm) x 150mm
<b>001574</b>	Small Connecting Bar 1/8" (3.2mm) x 175mm
<b>001575</b>	Small Connecting Bar 1/8" (3.2mm) x 200mm
<b>001597</b>	ESF Hinge Joint Small
<b>001566</b>	Spanner 7mm

## KE Plus Medium Range

<b>001526</b>	Medium Single KE Plus Clamp
<b>001592</b>	Medium Double Clamp
<b>001588</b>	Medium Connecting Bar 3/16" (4.8mm) x 75mm
<b>001576</b>	Medium Connecting Bar 3/16" (4.8mm) x 100mm
<b>001587</b>	Medium Connecting Bar 3/16" (4.8mm) x 150mm
<b>001589</b>	Medium Connecting Bar 3/16" (4.8mm) x 200mm
<b>001589XL</b>	Medium Connecting Bar 3/16" (4.8mm) x 250mm
<b>001589XXL</b>	Medium Connecting Bar 3/16" (4.8mm) x 300mm
<b>001598</b>	ESF Hinge Joint Medium
<b>001565</b>	Spanner 8mm

## KE Plus Large Range

<b>001525</b>	Large Single KE Plus Clamp
<b>001584</b>	Large Double Clamp
<b>001586</b>	Large Connecting Bar 5/16" (8mm) x 100mm
<b>001563</b>	Large Connecting Bar 5/16" (8mm) x 150mm
<b>001585</b>	Large Connecting Bar 5/16" (8mm) x 240mm
<b>001549</b>	Large Connecting Bar 5/16" (8mm) x 340mm
<b>001564</b>	Spanner 10mm

**Spanners**



Standard spanners are available for all clamp sizes see reference chart.

- 001566 Spanner 7mm
- 001565 Spanner 8mm
- 001564 Spanner 10mm

**Spanner Size & Clamp Type Reference Chart**

Clamp Type	Clamp Size	Clamp Code	Spanner Size	Spanner Code
KE+	Small	001527	7mm	001566
	Medium	001526	8mm	001565
	Large	001525	10mm	001564
SF Clamps Single	Mini	001740	7mm	001566
	Small	001741	8mm	001565
	Large	001742	10mm	001564
SF Clamps Double	Mini	001743	7mm	001566
	Small	001744	8mm	001565
	Large	001745	10mm	001564

**Epoxy ESF Putty**

Epoxy ESF Putty is a simple to use, quick & convenient alternative to the standard bar & clamp system. The putty, once mixed, stiffens in 5 minutes & within 1 hour is fully cured. The putty can be applied & then the fracture reduced allowing precise manipulation of the fracture site. The versatility of the system allows the putty to be used in place of clamps, to cover sharp ends of cut pins, & many other applications.

There are two pack sizes in a bar format with the premeasured catalyst in the centre of the bar ready for mixing. The product is clean & has a long shelf life. Only mix the quantity you need, cutting the required amount off the end of the bar. If you find you don't have enough, more can be prepared in a matter of seconds. ESF putty sticks to itself very well & may be used for repairs & corrections. Particularly useful in fractures in small furries where proximal & distal fragments may be attached together with 'blobs' of putty in place of clamps regardless of fixation pin site.

**Typical Applications**

- ESF applications requiring multiple pins of various sizes placed at various angles
- ESF applications in rabbits & guinea pigs
- Fractures of the jaw
- Protecting sharp ends of cut pins
- Joining non-standard pins & bars
- Use to add a pin mid-frame



- EPOXY1 Epoxy ESF Putty 55g
- EPOXY2 Epoxy ESF Putty 110g

**ESF Box**

- 001578 ESF Box With Partitions



**Email Marketing Service**

Our marketing emails are designed to **educate**, to keep you up to date with what's new at Vi & share **exclusive offers & discounts**.

Sign up today by scanning the QR code below.



## FESSA External Fixation

### FESSA External Fixation - Stainless Steel

Developed for use in the French army FESSA is a lightweight tubular fixator with a number of interesting features.

- The tube incorporates the pin clamping mechanism & is thus very strong & has extremely good angular pin rigidity
- Available in 6mm, 8mm & 12mm diameter tubes
- 6mm tube accepts pins of shaft diameter 0.9mm to 1.8mm making it extremely useful in the management of fractures in cats & exotics
- 8mm tube accepts pins of shaft diameter 1.6mm to 3.2mm
- 12mm tube accepts pins of shaft diameter up to 4mm & M5 grub screws
- Design allows placement of multiple parallel pins close together in small fragments
- Pins can be placed at right angles to tube or angled through adjacent holes. Pins are locked into position by hex driven grub screws



The full kit list is available upon request.

**015500** FESSA 6 & 8mm Set With 10 of Each Screw

#### 6mm FESSA

- 015502** FESSA Tube 6mm x 30mm
- 015504** FESSA Tube 6mm x 45mm
- 015506** FESSA Tube 6mm x 65mm
- 015508** FESSA Hex Driver Allen Key Type 1.5mm
- 015509** FESSA 6mm (1.5 Hex) Grub Screws (10)
- 015534** FESSA 6mm Hinge

#### 8mm FESSA

- 015510** FESSA Tube 8mm x 100mm
- 015512** FESSA Tube 8mm x 150mm
- 015514** FESSA Tube 8mm x 200mm
- SDHS20-I** 1.5/2.0/2.4mm Hex Screwdriver & Screw Holding Sleeve
- 015517** FESSA Hex Driver Allen Key Type 2.0mm
- 015520** FESSA 8mm (2.0 Hex) Grub Screws (10)
- 015536** FESSA 8mm Hinge

#### 12mm FESSA

- 015540** FESSA Tube 12mm x 125mm
- 015542** FESSA Tube 12mm x 175mm
- 015544** FESSA Tube 12mm x 225mm
- 015545** FESSA 12mm (2.5 Hex) Grub Screws (10)
- SDHS35POM-C** 2.5mm Hex Screwdriver + Sleeve With PTFE Handle

### FESSA Ultra-Lightweight Titanium FESSA



Standard stainless steel FESSA is light. The tubular structure acts as both clamp & bar. Birds, small furrries & exotics demand even lighter constructs. Using Titanium tube of 5.0mm in diameter enables the surgeon to apply FESSA constructs weighing from as little as 1.5 grams.

Titanium FESSA tubes (015521 & 015522) are both supplied with 6x M3 grub screws. Suitable for pins 0.8mm to 1.6mm. Uses 1.5 hex drivers, the same as 6.0mm FESSA.



The full kit list is available upon request.

**015530** Titanium FESSA Set In Stainless Steel Box

#### Components:

- 015521** 5mm x 30mm Titanium FESSA
- 015522** 5mm x 45mm Titanium FESSA
- 015509** FESSA 5mm (1.5 Hex) Locking Screws (10)
- 015508** 1.5 Hex Allen Key
- BCNET08** 0.8mm Bicortical Negative Pins
- BCNET10** 1.0mm Bicortical Negative Pins
- BCNET15** 1.5mm Bicortical Negative Pins

To view our Surgery Guide on 'Linear External Skeletal Fixation', please scan the QR code below.



## Pin Reference Chart

	Bar Diameter	Small 3.2mm 1/8"	Medium 4.8mm 3/16"	Large 8mm 5/16mm	Mini 3.2mm 1/8"	Small 6.3mm 1/4"	Large 9.5mm 1/3"	
		KE Plus	KE Plus	KE Plus	Standard SF	Standard SF	Standard SF	
Code	Shaft Diameter							
<b>Positive Threaded Pins - End Thread</b>								
CET0014	Positive End Thread Pin 0.8mm Shank 1.1mm Thread 60mm Long							
CET0013	Positive End Thread Pin 1.0mm Shank 1.3mm Thread 65mm Long	●			●			
CET0015	Positive End Thread Pin 1.2mm Shank 1.5mm Thread 65mm Long	●			●			
CET0016	Positive End Thread Pin 1.2mm Shank 1.6mm Thread 70mm Long	●			●			
CET0017	Positive End Thread Pin 1.4mm Shank 1.8mm Thread 70mm Long	●			●			
CET0018	Positive End Thread Pin 1.6mm Shank 2mm Thread 70mm Long	●	●		●			
CET0026	Positive End Thread Pin 1.8mm Shank 2.2mm Thread 80mm Long	●	●	●	●			
CET0019	Positive End Thread Pin 2mm Shank 2.4mm Thread 85mm Long	●	●	●	●	●		
CET0020	Positive End Thread Pin 2.4mm Shank 3.2mm Thread 100mm Long	●	●	●	●	●		
CET0020A	Positive End Thread Pin 2.7mm Shank 3.5mm Thread 110mm Long	●	●	●		●		
CET0020B	Positive End Thread Pin 3mm Shank 3.8mm Thread 120mm Long		●	●		●	●	
CET0021	Positive End Thread Pin 3.2mm Shank 4mm Thread 130mm Long		●	●		●	●	
CET0022	Positive End Thread Pin 4mm Shank 4.8mm Thread 150mm Long		●	●			●	
CET0024A	Positive End Thread Pin 3.5mm Shank 4.3mm Thread 130mm Long		●	●			●	
<b>Positive Threaded Pins - Mid Thread</b>								
CMT0013	Positive Mid Thread Pin 0.8mm Shank 1.1mm Thread 85mm Long							
CMT0014	Positive Mid Thread Pin 1.1mm Shank 1.4mm Thread 85mm Long				●			
CMT0015	Positive Mid Thread Pin 1.2mm Shank 1.5mm Thread 85mm Long				●			
CMT0016	Positive Mid Thread Pin 1.4mm Shank 1.8mm Thread 85mm Long				●			
CMT0017	Positive Mid Thread Pin 1.6mm Shank 2mm Thread 85mm Long	●	●		●			
CMT0018	Positive Mid Thread Pin 1.6mm Shank 2mm Thread 85mm Long	●	●		●			
CMT0018A	Positive Mid Thread Pin 1.8mm Shank 2.2mm Thread 90mm Long	●	●		●			
CMT0019	Positive Mid Thread Pin 2mm Shank 2.4mm Thread 105mm Long	●	●	●	●	●		
CMT0019A	Positive Mid Thread Pin 2.2mm Shank 2.6mm Thread 105mm Long	●	●	●		●		
CMT0023	Positive Mid Thread Pin 2.4mm Shank 3.2mm Thread 105mm Long	●	●	●		●		
CMT0023A	Positive Mid Thread Pin 2.7mm Shank 3.5mm Thread 115mm Long	●	●	●			●	
CMT0023B	Positive Mid Thread Pin 3mm Shank 3.8mm Thread 120mm Long		●	●			●	
CMT0024	Positive Mid Thread Pin 3.2mm Shank 4mm Thread 130mm Long		●	●			●	
CMT0024A	Positive Mid Thread Pin 3.5mm Shank 4.3mm Thread 140mm Long		●	●			●	
CMT0025	Positive Mid Thread Pin 4mm Shank 4.8mm Thread 150mm Long		●	●			●	
<b>Trochar Pins</b>								
001556	Trochar Pin 2.0mm	●	●		●	●		
001557	Trochar Pin 3.0mm	●	●	●		●	●	
001558	Trochar Pin 4.0mm		●	●			●	



## Pin Reference Chart Continued

	Bar Diameter	Small	Medium	Large	Mini	Small	Large
		3.2mm 1/8"	4.8mm 3/16"	8mm 5/16mm	3.2mm 1/8"	6.3mm 1/4"	9.5mm 1/3"
	Clamp Style	KE Plus	KE Plus	KE Plus	Standard SF	Standard SF	Standard SF
Code	Shaft Diameter						
<b>Cortical Negative Threaded Pins - Ellis Type</b>							
001528	Ellis Pin 1.1mm	●			●		
001529	Ellis Pin 1.6mm	●			●		
001533	Ellis Pin 1.8mm	●	●		●		
001550	Ellis Pin 2.0mm	●	●		●	●	
001530	Ellis Pin 2.4mm	●	●	●	●	●	
001550A	Ellis Pin 2.7mm	●	●	●		●	
001551	Ellis Pin 3.0mm	●	●	●		●	
001531	Ellis Pin 3.2mm	●	●	●		●	●
001551A	Ellis Pin 3.5mm	●	●	●			●
001552	Ellis Pin 4.0mm	●	●	●			●
<b>Bicortical Fine Negative Threaded Pins</b>							
BCNET08	0.8mm Bicortical Pin Negative End Thread Pin 70mm						
BCNET10	1mm Bicortical Pin Negative End Thread Pin 70mm	●			●		
BCNET11	1.1mm Bicortical Pin Negative End Thread Pin 70mm	●			●		
BCNET13	1.4mm Bicortical Pin Negative End Thread Pin 70mm	●			●		
BCNET15	1.5mm Bicortical Pin Negative End Thread Pin 70mm	●			●		
BCNET16	1.6mm Bicortical Pin Negative End Thread Pin 70mm	●			●		
BCNET18	1.8mm Bicortical Pin Negative End Thread Pin 85mm	●	●		●		
BCNET20	2mm Bicortical Pin Negative End Thread Pin 85mm	●	●		●	●	
BCNET24	2.4mm Bicortical Pin Negative End Thread Pin 100mm	●	●	●	●	●	
BCNET27	2.7mm Bicortical Pin Negative End Thread Pin 110mm	●	●	●		●	
BCNET30	3mm Bicortical Pin Negative End Thread Pin 130mm	●	●	●		●	
BCNET35	3.5mm Bicortical Pin Negative End Thread Pin 130mm	●	●	●			●
BCNET40	4mm Bicortical Pin Negative End Thread Pin 150mm		●	●			●
BCNET50	5mm Bicortical Pin Negative End Thread Pin 150mm		●	●			



# Surgical Power Tools



To view the Surgical Power Tool area of our website, please scan the QR code:





We are delighted to continue our partnership with B. Braun Medical Ltd.

The Acculan 4 small drill and TPLO saw meet all needs for veterinary surgeries in a compact, yet powerful and simple to use system. Constructed to the ergonomics of the hand and delivering technology which is synonymous with reliability and longevity.

## AESCULAP® Acculan 4

### Acculan 4 Small Drill

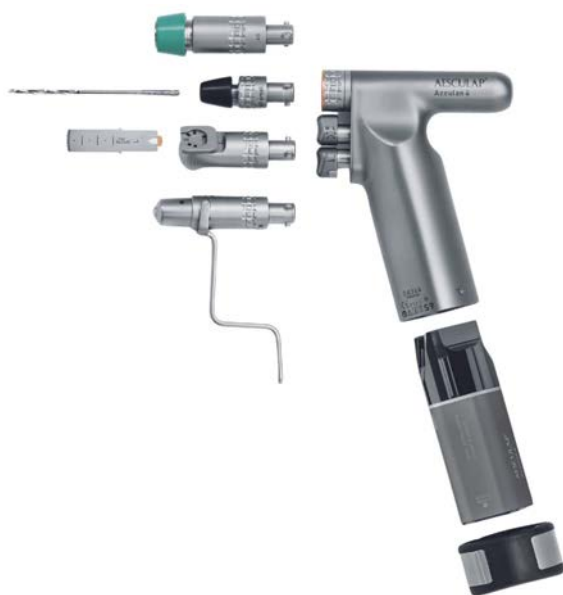

The Acculan 4 is a modular battery-operated power system from Aesculap. This system is small and lightweight with a easy to handle titanium housing.

Drill includes:

- GA678 - Sterile Funnel
- GA344244 - K-Wire Protection Guide
- GB600880 - Sterilit Spray Adaptor

- GA344** Acculan 4 Small Drill
- GA675** Acculan 4 Lid

### Acculan 4 Small Drill Attachments

- GB881R** Acculan 4 Large Jacobs Chuck 0.5-7.4mm
- GB884R** Acculan 4 Small AO Chuck Attachment
- GB891R** Acculan 4 Sagittal Saw Attachment
- GB892R** Acculan 4 Reciprocating Saw Attachment
- GB894R** Acculan 4 K-Wire Driver 0.6-3.2mm
- GB870R** Acculan 4 Reamer Attachment Large Jacobs Chuck

### Acculan 4 Sagittal Saw Blades

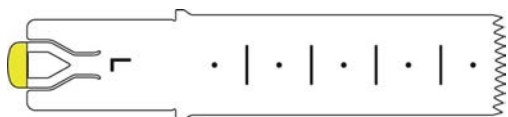

Supplied in single sterile packs.

	Length (mm)	Width (mm)	Cut Thickness (mm)
<b>GP501R</b>	15	5	0.5
<b>GP502R</b>	15	10	0.5
<b>GP504R</b>	20	5	0.5
<b>GP505R</b>	20	10	0.5
<b>GP514R</b>	25	5	0.7
<b>GP515R</b>	25	10	0.7
<b>GP516R</b>	25	15	0.7
<b>GP521R</b>	35	5	0.5
<b>GP523R</b>	35	15	0.7
<b>GP524R</b>	35	20	0.7
<b>GP535R</b>	50	10	0.8
<b>GP536R</b>	50	15	0.8
<b>GP537R</b>	50	20	0.9
<b>GP538R</b>	50	25	0.9
<b>GP539R</b>	50	30	0.9

### Acculan 4 TPLO Saw



The Acculan 4 TPLO saw has a straight ergonomic design with titanium housing. The triangular mount allows use of Aesculap or Vi TPLO blades.

- GT666** Acculan 4 TPLO Straight Handpiece
- GA675** Acculan 4 Lid

### Acculan 4 Battery and Charging Unit



Battery can be used with Acculan 4 small drill and TPLO saw. Charger can be used with both NiMH and Li-Ion batteries.

- GA320** Acculan 4 Battery Charging Unit
- TE734** UK Mains Cable
- GA346** Acculan 4 Li-Ion Battery

### Surgical Power Tool Lubrication

- GB600** Sterilit Power System Oil Spray
- GB600880** Sterilit Oil Spray Adaptor For GA344

### Acculan 4 Storage

Can be used with Acculan 4 small drill and TPLO saw.



- JF282R** Basket For JN096
- JF289R** Basket Lid For JF282R
- JF938** Silicone Mat Mesh Fitting 1/2 Basket
- JN096** Dental Sterile Container & Lid

### Acculan 4 Accessories

- GA678** Sterile Funnel
- GA679** Battery Removal Device
- GA344244** K-Wire Protection Guide For Small Drill
- JK091** Sterile Container Reusable Filter Pack of 2

Acculan 4 Large Drill and Reamer Handpiece and Attachments available on request.

A wider range of products are available. Please contact us for specific requirements.

**B | BRAUN**  
SHARING EXPERTISE

## DeSoutter Vdrive™ System

The DeSoutter Vdrive™ veterinary range is lightweight and fully modular and comprises a large and small bone system which share a common battery platform.

### V-MBQ Large Bone Powered Instrument Range

The V-MBQ is suitable for large bone surgery, with a unique TPLO attachment. A single handpiece will cover all large bone veterinary procedures with its comprehensive range of attachments. All attachments in this range will fit both pistol grip and straight case handpieces to accommodate all surgeons' preferences.



**DSI291884** V-MBQ-708 Vdrive™ Modular Handpiece - Twin Trigger



**DSI293774** V-MBQ-807 Vdrive™ Modular Straight Case Handpiece

### V-MBQ Attachments

Fit both V-MBQ-708 twin trigger handpiece and V-MBQ-807 straight case handpiece.

- DSI8320** V-DQ-708 Vdrive™ Keyed Chuck 0.5-6.4mm (1/4") For MBQ
- DSI8330** V-DQ-708 Vdrive™ Small AO Synthes/ASIF Chuck For MBQ
- DSI8440** V-RQ-708 Vdrive™ Keyed Reamer Attachment 0.5-6.4mm (1/4") For MBQ
- DSI8300** V-NQ-707 Vdrive™ Small Sagittal Saw Uses S88 Blades For MBQ
- DSI8690** V-OQ-708 Vdrive™ TPLO Oscillating Saw. Uses R Series & Synthes Blades For MBQ
- DSI8270** V-OQ-708 Vdrive™ TPLO Oscillating Saw. Uses Slocum Blades For MBQ
- DSI8310** V-WQ-707 Vdrive™ Wire Driver. 0.7 - 4.0 mm wire capacity For MBQ

- 6 months warranty for battery
- 12 months warranty on hand pieces and attachments

### V-MBU Small Bone Powered Instrument Range

The V-MBU is suitable for small bone surgery. High speed and oscillating drilling, low speed drilling, screw driving and tapping. There is no TPLO attachment to fit the small bone handpiece.



**DSI292444** V-MBU-470 Vdrive™ Modular Handpiece - Twin Trigger

### V-MBU Attachments

- DSI8780** V-DU-470 Vdrive™ Keyed Chuck 0.5-4.0mm (5/32") For MBU
- DSI8770** V-DU-470 Vdrive™ Keyed Chuck 0.5-7.4mm (1/4") For MBU
- DSI8800** V-DU-470 Vdrive™ AO Synthes/ASIF Chuck For MBU
- DSI8820** V-RU-470 Vdrive™ Keyed Reamer 0.5-7.4mm (1/4") For MBU
- DSI8870** V-SU-470 Vdrive™ Mini Sagittal Saw Uses S85 Blades For MBU
- DSI8880** V-NU-470 Vdrive™ Quick Release Sagittal Saw Uses S88 Blades For MBU
- DSI8910** V-WU-471 Vdrive™ Wire/Pin Driver 0.7 – 4.0mm Capacity For MBU

### Aseptic Small Batteries For Vdrive™

Can be used with both large V-MBQ and small V-MBU handpieces.

- DSI7910** AB-703 Vdrive™ Small Battery Pack (10.95V)
- DSI8850** V-AH-703 Vdrive™ Battery Housing for AB-703 Battery
- DSI8100** AS-703 Vdrive™ Battery Shield for AB-703 Battery
- DSI8000** BC-707 Single Bay Charger for AB-703 Battery

Large battery (14.6V) and sterilisable Lithium Ion batteries available on request.

### Blades

S85 blades fit DSI8870 V-SU-470 mini sagittal saw for small bone handpiece (MBU)

	Length (mm)	Width (mm)	Cut Thickness (mm)
<b>S85-103</b>	22	6	0.7
<b>S85-100</b>	23	10	0.7
<b>S85-110</b>	35	10	0.7

All listed supplied as a sterile single blade. Other blades are available to buy in packs of 5.

S88 blades fit DSI8300 V-NQ-707 small sagittal saw for large bone handpiece (MBQ) and DSI8880 V-NU-470 quick release sagittal saw for small bone handpiece (MBU).

	Length (mm)	Width (mm)	Cut Thickness (mm)
<b>S88-103</b>	22	6.4	0.6
<b>S88-100</b>	25	10	0.6
<b>S88-110</b>	35	10	0.6
<b>S88-109</b>	46	15	0.6

All listed supplied as a sterile single blade. Other blades are available to buy in packs of 5.

### Vi Black Series Battery Powered Drill/Saw Set



The Vi Black Series Drill/Saw Set contains:

- Black Series Drill
- Black Series Saw
- 1x Conditioning Charger
- 2x Batteries
- 2x Battery Transfer Sleeves
- 2x Storage Cases

**BLACKKITUK**

Vi Black Series Drill & Saw Set UK

### Vi Black Series Battery Powered Drill



Supplied complete with battery, battery charger, battery transfer sleeve & storage case.

The drill has a reverse & is fitted with a 4.8mm capacity three jaw chuck with 3.0mm through cannulation for driving smaller pins, wires & drill bits.

Drill max speed: 0-1100RPM  
 Drill max noise: <40dB  
 Drill weight: 990g

**BLACKDRILL**

Vi Black Series Drill Set

**BLACKCHUCKKEY**

Vi Black Series Drill Spare Chuck Key

### Vi Black Series Conditioning Charger



**VIBLKCHGUK**  
**BLACKBAT**

Vi Black Series Conditioning Charger (UK)

Vi Black Series Spare Battery

- 6 months warranty for battery
- 12 months warranty on hand pieces

### Vi Black Series Attachment



**BLACKDRILL-QRAC**

Vi Black Series Cannulated QR Attachment

### Vi Black Series Battery Powered Surgical Saw



Supplied complete with battery, battery charger, battery transfer sleeve, storage case and 1x BLACKSW451607B blade.

Saw speed: 0-15000 osc/min  
 Saw max noise: <50dB  
 Saw weight: 782g

**BLACKSAW**

Vi Black Series Saw Set

### Vi Black Series Saw Blades

We stock a range of Black Series Saw Blades which have been specifically designed for Veterinary patients.

Ideal for TTA/TTO style cruciate surgeries, other elective osteotomies & excisional arthroplasty.

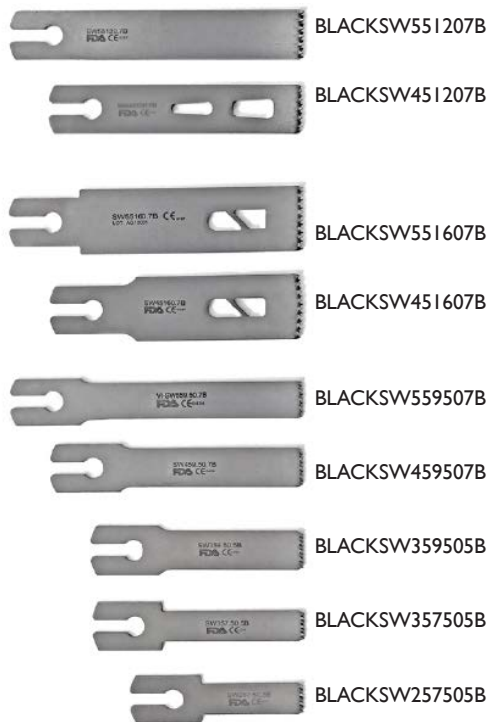

Blades not to scale

	Cut Thickness	Working Length	Width
<b>BLACKSW257505B</b>	0.75	20	7.5
<b>BLACKSW357505B</b>	0.75	30	7.5
<b>BLACKSW359505B</b>	0.75	30	9.5
<b>BLACKSW459507B</b>	0.95	40	9.5
<b>BLACKSW45I207B</b>	0.95	40	12
<b>BLACKSW45I607B</b>	0.95	40	16
<b>BLACKSW559507B</b>	0.95	50	9.5
<b>BLACKSW55I207B</b>	0.95	50	12
<b>BLACKSW55I607B</b>	0.95	50	16

### Black Series Aluminium Sterilisation Cases

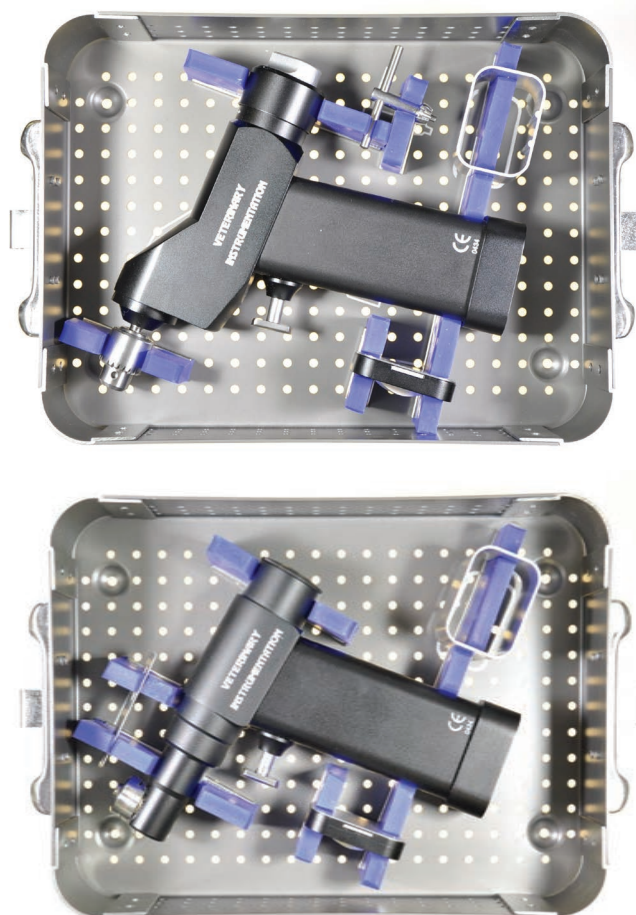

Designed specifically for the Vi Black Series Drill & Saw & suitable for use in larger autoclaves. Cases outer dimensions are 300x205x70mm.

**BLACKDRILL-SC** Sterilisation Case For Black Series Drill

**BLACKSAW-SC** Sterilisation Case For Black Series Saw



### Vi Battery Powered TPLO Saw



- Supplied with:
- Transportation Case
  - Saw
  - Batteries x2
  - Conditioning Charger
  - Sterile Battery Transfer Sleeve

A sterilisation case is also available.

- VITPLOSAW** Vi Battery Powered TPLO Saw
- VITPLOSAW-SC** Vi TPLO Sterilisation Case
- VITPLOCHG** Vi TPLO Saw Conditioning Charger (UK Plug)
- VITPLOBAT** Vi TPLO Saw Replacement Battery
- ALLEN25** 2.5mm Allen Key Stainless Finish
- GRUBM5L5** Grub Screw M5 x 5mm
- TPLOSAWLID** TPLO Saw Lid

### TPLO Saw Blades Vi Pattern



Vi's updated TPLO Blade has been redesigned to further reduce friction & improve cut characteristics in all sizes.

- TPLOVI12** TPLO Blades Vi Pattern 12mm
- TPLOVI15** TPLO Blades Vi Pattern 15mm
- TPLOVI18** TPLO Blades Vi Pattern 18mm
- TPLOVI21** TPLO Blades Vi Pattern 21mm
- TPLOVI24** TPLO Blades Vi Pattern 24mm
- TPLOVI27** TPLO Blades Vi Pattern 27mm
- TPLOVI30** TPLO Blades Vi Pattern 30mm
- TPLOVI34** TPLO Blades Vi Pattern 34mm

### TPLO Saw Blade 9mm



Vi are pleased to offer a 9mm radial cut TPLO blade by Rita Leibinger. Standard triangular mount fitting.

- TPLOBLEI09** Rita Leibinger 9mm TPLO Saw Blade

### TPLO Saw Hex Driver T Bar Type



The fitting on most TPLO saw blades is of the triangular Stryker Type. The means of attachment to the saw is by hex drive grub screws which are notorious for working loose.

Our T Bar hex drivers allow the surgeon to quickly, easily & firmly attach the blade to the saw.

Available in 2.5mm (Slocum), 3.0mm (Aesculap) & 3.2mm (Whittemore/ Vi).

- TBHEX25** 2.5mm T Bar Hex Driver (Slocum)
- TBHEX30** 3.0mm T Bar Hex Driver (Aesculap)
- TPLOHEX32** 1/8" Stainless Allen Key (Whittemore/ Vi)
- ALLEN25** 2.5mm Allen Key Stainless
- 015508** 1.5mm Allen Key
- 015517** 2.0mm Allen Key

### TPLO Saw Blade Protractor

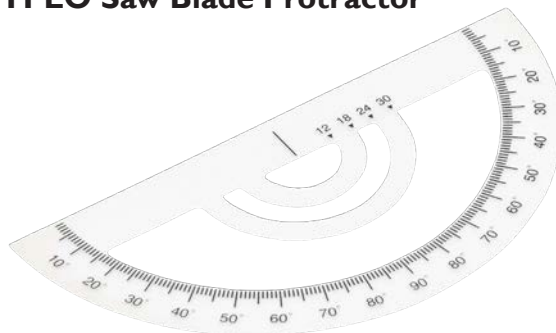

Use to accurately measure the tibial plateau slope. In addition the protractor is marked with blade outline to further assist in the planning of the TPLO procedure.

- TPLOPRO** TPLO Protractor

Description	Vi Code	Hex Driver	Vi Code
Whittemore Saw Grub Screw	TPLOSCREW	1/8"	TPLOHEX32 (Allen Key)
Slocum Saw Screw	SLOSCREW	2.5MM	TBHEX25 (T BAR)
Aesculap Saw Grub Screw	SPECIAL ORDER FROM AESCULAP	3.0MM	TBHEX30 (T BAR)
TPLO Jigs	JIGSCREW	2.5MM	TBHEX25 (T BAR)
Arthroscopic Distractor	JIGSCREW	2.5MM	TBHEX25 (T BAR)
FESSA 6mm	015509	1.5MM	015508 (Allen Key)
FESSA 8mm	015520	2.0MM	015517 (Allen Key)

### Multi Saw Battery Powered System

This multi-functional oscillating saw can be used for powered bone dissection, where an oscillating motion is required & also acts as a dedicated cast cutter.

The saw is supplied as a kit & includes a charging unit, two batteries, & a blade.



- 001708** Multi Saw Surgical Kit incl Converter, Shroud, Titanium Nitride Coated Blade & S82-103 Blade
- 001708.134** Multi Saw Surgical Kit incl Converter, Shroud, Titanium Nitride Coated Blade & SB5071-134 Blade Suitable for TTO & TTA Rapid
- 001702** Stainless Converter supplied with spanner
- 001703** Waterproof Shroud For Multi Saw
- 001705** Multi Saw Diamond Blade
- 001714** Multi Saw Titanium Nitride Coated Blade
- M12B2MIL** Spare Battery For Milwaukee Multi Saw and Drill
- M1218FCMIL** Charging Unit For Milwaukee Batteries 240V

### Surgical Blades

All blades with a central hole bigger than 6mm will fit the Multi Saw.

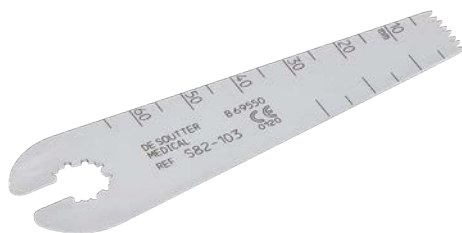

	THICKNESS	CUT	LENGTH	WIDTH
<b>S82-100</b>	0.46mm	0.9mm	42mm	13mm
<b>S82-103</b>	0.81mm	1.2mm	70mm	12mm
<b>S82-104</b>	0.81mm	1.2mm	70mm	25mm
<b>SB5071-134</b>	0.38mm	0.6mm	41mm	9.0mm
<b>SB5071-133</b>	0.38mm	0.6mm	25mm	9.5mm
<b>S85-110</b>	0.4mm	0.7mm	33mm	10.0mm

### Multi Saw Blades

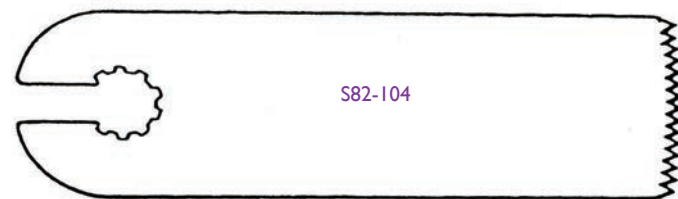
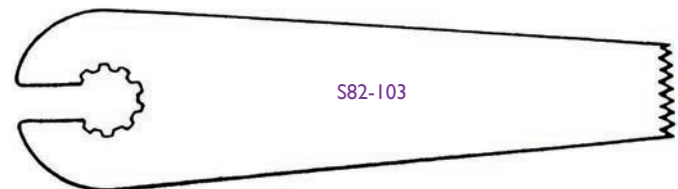

## Variable Speed Orthopaedic Drill (Milwaukee) & Accessories

The drill system is from an industrial background, modified for the Animal Health industry.

- Excellent control over speed 0-600rpm via trigger
- Stainless Steel Chuck (6.35mm capacity) & Extension
- 80mm through Chuck cannulation
- Autoclavable Shroud
- Low Speed, High Torque
- Supplied as a Complete Kit including Stainless Chuck, Key, Extension, Autoclavable Shroud, 2 Batteries & a Charger.



- 001600** Variable Speed Orthopaedic Drill (Milwaukee) Kit - Drill, Chuck, Key, Shroud, Extension & 2x Batteries
- 001605** Spare Chuck and Key 1/4" 6.35mm
- 001606** Spare Key For Standard Chuck
- 001607** Drill Extension
- 001661A** Waterproof Shroud
- M12B2MIL** Spare Battery For Milwaukee Multi Saw and Drill
- M1218FCMIL** Charging Unit For Milwaukee Batteries 240V
- 001620** Waterproof Drill Shroud for Pre-2014 Makta Style Drill



### Loan Kits

For a nominal fee, we have a range of **specialist loan kits** available to complement your own fleet. With next working day availability, the service offers flexibility as procedures are booked with your clients.

To find out more, scan the QR code below.



**MiniDriver Basic Set**



**VIMDB2** MiniDriver Basic Set Including MK 2 Saw

**K200 MiniDriver Handpiece**



Fully re-furbished to the new K200 standard, the handpiece is the centre of the modular system.

Handpiece has forward & reverse button plus locking trigger.

Power output with medical air at 7bar input is 0.78 Newton Meters.

Speed variable 0-1100rpm.

**K200VI** K200 Handpiece

**K111 Wire Driver**



Re-attachment of osteotomies or small bone fragments is often best achieved using K or arthrodesis A wires. Driving a long pin in a chuck often results in bending & kinking making driving difficult. Incrementally advancing the wire through a chuck is often time consuming. The wire driver allows the easy incremental advancement of the wire through the handpiece via the use of a clutch arrangement.

**K111VI** Wire Driver 0.7mm To 1.8mm

**K211 Pin Driver**



Similar to the wire driver in operation the pin driver has a larger capacity 1.6m to 4mm.

**K211VI** K211 Pin Driver 1.6 To 4mm

**K110 Small 4mm Jacobs Chuck**



The 4mm chuck attachment is cannulated for driving long pins.

**K110VI** K110 4mm Chuck Attachment Including Key

### K109 Large 6.25mm Jacobs Chuck



The 6.25mm chuck attachment is cannulated for driving long pins.

**K109VI** K109 6.25mm Chuck Attachment Including Key

### K210 Hi Torque Large 6.25mm Jacobs Chuck



Using the standard chucks the MiniDriver has a torque of 0.78 Newton Meters, which makes heavy weather of driving large pins without pre-drilling.

By adding a set of gears the chuck speed is reduced but the stall torque is increased to 2.8 Newton Meters ideal for driving pins.

**K210VI** K210 Hi Torque 6.25mm Chuck Attachment

### K107VI Keyless Chuck Attachment



Chuck keys wear quickly, become lost & can be awkward to use in some situations. The keyless chuck allows the surgeon to quickly switch drills & pins without a key.

The distal part of the chuck is held using fingers & the chuck opened or closed by engaging the drill in either the forward or reverse drive respectively. The downside is that the chuck is slightly bulkier than the keyed equivalent.

**K107VI** Keyless Chuck Attachment 0 - 6.3mm

### K114B AO Quick Release Attachment



Drills may be changed quickly without the use of a chuck key. The original version was made from relatively soft aluminium. The re-manufactured K114B is made from stainless steel & is easier to use than the original.

**K114BVI** K114B AO Quick Release Attachment

### K220 Blades



	CUT THICKNESS	LENGTH	WIDTH
<b>K141</b>	1.0mm	14.2mm	6.4mm
<b>K142</b>	1.0mm	30.0mm	6.4mm
<b>K144</b>	1.0mm	30.0mm	10.2mm
<b>K146</b>	0.65mm	27.4mm	19.0mm
<b>K147</b>	0.65mm	27.4mm	14.0mm
<b>K148</b>	0.65mm	27.4mm	9.5mm
<b>K149</b>	0.65mm	42.7mm	19.1mm
<b>K152</b>	0.65mm	30.0mm	6.4mm
<b>K154</b>	0.65mm	42.7mm	9.5mm
<b>K155</b>	0.65mm	42.7mm	14.0mm

### K220 Mark II Sagittal Saw



The Mark II Saw is more robust in construction than the K120 Saw. Blade attachment is by use of a Hex Wrench. While this gave a more rigid attachment of the blade to the saw it was also the weak point of the attachment.

We have re-engineered the blade holding mechanism to make it stronger & made the whole attachment from stainless steel.

The Mark II Saw drives a larger range of blades including longer ones up to 42mm useful in the TTO & TTA procedures.

**K220VI** K220 Mark II Sagittal Saw Attachment

**K201VI** Replacement Wrench For K220VI

### K120 Blades



	CUT THICKNESS	LENGTH	WIDTH
<b>K123</b>	1.0mm	15.1mm	10.4mm
<b>K124</b>	1.0mm	31.0mm	10.4mm
<b>K125</b>	1.0mm	15.1mm	16.5mm
<b>K132</b>	0.7mm	31.0mm	6.4mm
<b>K133</b>	0.7mm	15.1mm	10.4mm

### MiniDriver Hose

The standard hose is a 3m long double hose which vents back at the wall gas outlet or the regulator. In the UK the standard drive gas is bottle sterile medical air delivered at 7bar (100psi). Elsewhere in the world nitrogen may be used.

The standard hose supplied is fitted with an MA7 gas probe (medical air at 7bar) which prevents connection to other gases e.g. oxygen.

**3MHOSEVI** MiniDriver Hose

**3MHOSEVIUS** MiniDriver Hose US Schrader

**3MHOSEVI5M** MiniDriver Hose To A201 Spec - 5 Metre Long

## Air Hoses

### What do I need?

To get the correct hose you will need to know two things – the make/model of instrument the hose is to fit, and the type of supply outlet you have.

Outlet connectors cause most fitting issues. Most usual outlet – UK MA7. This will only accept UK MA7 probes. If your hose pushes in, but will not click home, the hose usually has a US Schrader fitting. Hoses sourced outside the UK & USA are very unlikely to be compatible with UK outlets as each country has its own connectors for safety reasons.

Hose outlet connectors are shown with the relevant outlet. Schrader hoses can be as shown but can also have no gutter round the probe.

A UK MA7 probe will fit a Schrader socket, but a Schrader probe will NOT fit a UK MA7 outlet without a special adaptor

### UK MA7

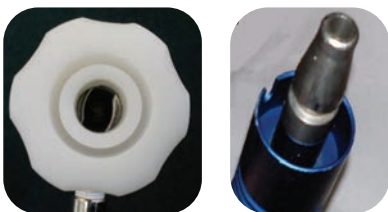

### SCHRADER



### Common Instrument Connectors:



**3M Connector** – fits MiniDriver, MicroDriver & Minos A200.



**Halls Connector** - fits most Halls Air Tools, Surgairtome Spinal System and many others.

## Air Instrument Care Products



Maintenance will ensure continuing excellent performance and minimal repair bills. It's crucial to follow manufacturer's guidelines.

- M317** Lubricant for MiniDriver and Minos
- M316** Vi Air Instrument Oil 15ml
- M316L** Vi Air Instrument Oil 120ml

## Air Regulators & Hose Probes

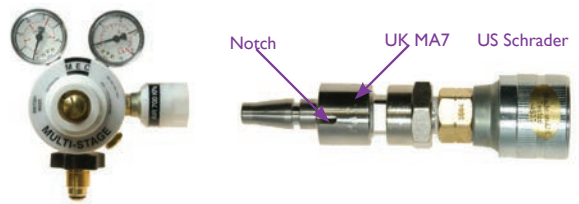

All the air equipment runs on medical air at 7 Bar (100PSI). Drills and saws can be run from compressors as their air requirement is intermittent. High speed drills need bottled gas or a big compressor. A twin dial regulator is best to control gas pressure (001756). One dial gives bottle pressure, the other one gives line pressure (7 Bar).

UK supplied hoses come with an MA7 probe (medical air 7 Bar pressure). Schrader fittings on hoses purchased from the USA look similar to UK MA7 probes. Many will however not lock into UK MA7 sockets. The best solution is to change the probe. A cheaper alternative is to use a Schrader/ MA7 Convertor (001758).

- 001756** Medical Air Regulator MA7 Outlet - Buy to order only
- 001758** MA7 Male to Schrader Female Plug in Adaptor

## Halls (Linvatec) Spinal Bur System Surgairtome II



Preferred by surgeons such as Simon Wheeler, the Surgairtome II has an air brake, so the bur stops immediately the trigger is released.

- 505800-A** Surgairtome II Kit. Includes Hose Medium Bur Guard & Motor
- 5058** Surgairtome II Handpiece Only
- HALLHOSEVI** Vi Hose – Halls Fitting 3m Long

## Bur Guards



- VIMBG** Medium Bur Guard For Burs 45-51mm Long
- VILBG** Long Bur Guard For Burs 70mm Long

## Halls Bur Guards



Spinning at 100,000 rpm the shaft needs support. These are the original Halls Guards.







- I375-023** Extra Long Halls Bur Guard
- I375-011** Long Halls Bur Guard
- I375-012** Medium Halls Bur Guard

### Burs

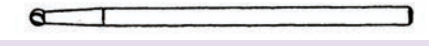
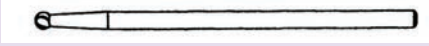
All surgical burs have a 2.36mm shank (HP fitting) & will fit in all high speed surgical bur systems e.g. 3M's Minos, Halls Surgairtome & Freedom.

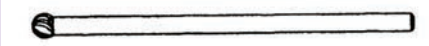
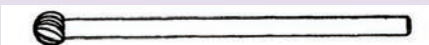
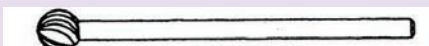
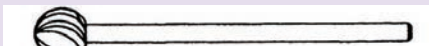
We have selected Komet burs for their high quality. All are single pack & non sterile. In human surgery, burs are regarded as disposable items. In veterinary surgery the cost precludes using burs as disposables. However, use of burs which are less than sharp extends procedure time & creates heat. We do advise that burs are checked & changed on a regular basis.

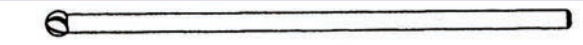
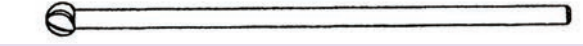
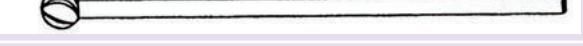
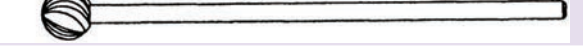
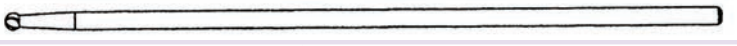
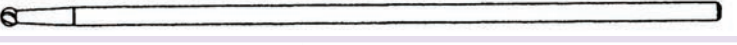
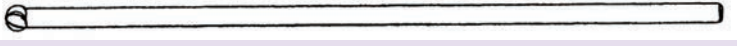
Diamond burs are sharper & create less heat than carbide equivalents. Adequate irrigation is essential.

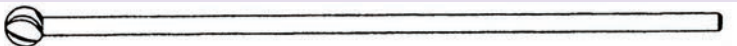
BURS		HEAD SIZE	OVREALL LENGTH	BUR GUARD	ORDER CODE (Carbide)	ORDER CODE (Diamond)
	illustrations are actual size	1.4mm	51mm	Medium		
		1.8mm	51mm	Medium	MR18R	
		2.0mm	51mm	Medium	MR20R	M20D
		2.3mm	51mm	Medium	MR23R	
		3.0mm	51mm	Medium	MR30R	
		4.0mm	51mm	Medium	MR40R	M40D
		5.0mm	51mm	Medium	MR50R	
		6.0mm	57mm	Medium		M60D
		1.8mm	70mm	Long	L18R	
		2.0mm	70mm	Long	L20R	L20D
		2.3mm	70mm	Long	L23R	
		2.7mm	70mm	Long	L27R	
		3.0mm	70mm	Long	L30R	L30D
		3.5mm	70mm	Long	L35R	
		4.0mm	70mm	Long	L40R	L40D
		4.5mm	70mm	Long	L45R	
		5.0mm	70mm	Long	L50R	L50D
		6.0mm	70mm	Long	L60R	L60D
		2.0mm	95mm	Extra Long	X20R	X20D
		2.3mm	95mm	Extra Long	X23R	
		3.0mm	95mm	Extra Long	X30R	X30D
		4.0mm	95mm	Extra Long	X40R	X40D
		5.0mm	95mm	Extra Long	X50R	X50D

### Bur Stands



001792BLOCK.ONLY

Bur Block Holds x6 Burs - Burs Not Included





# Spinal Surgery



To view the Spinal Surgery area of our website, please scan the QR code:



## Cervical Intervertebral Fusion Implant

C-LOX has been developed by Rita Leibinger in cooperation with Professor Dr. Frank Forterre, Bern University (Switzerland). Surgical protocol available on request.

### C-LOX Complete Set



The C-LOX Complete Set:

- C-Lox Tray x1
- Screwdriver Handle Silicone x1
- C-LOX Screwdriver Shaft 2.7mm Star-Drive 135mm AO x1
- Locking Drill Guide 2.7 (1 of each size working end) x5
- C-LOX Implantation Placement Rod 22cm x2
- C-LOX Spinal Curette 22cm x1
- Bone Drill AO Shaft Ø 2.0 mm 100/75 mm x1
- Bone Drill AO Shaft Ø 2.5 mm 110/85 mm x1
- C-LOX Spinal Cage Titanium, 2,7mm H-Plate with Almond Cage Locking with Spikes (1 of each size) x10
- C-LOX Sizing Cage for Spinal Cage H-Plate with Almond Cage (1 of each size) x10
- Star Drive Spinal Cage Locking Screw Titanium x5 of each length

**CLOX134010001** C-LOX Complete Set - New Version

### C-LOX Screwdriver Handle



Silicone handle, sterilisable up to 134°.

**CLOX247010200** C-LOX Screwdriver Handle

### C-LOX Screwdriver Shaft 2.7mm



Star Drive T10, 135mm long. AO connection, self holding.

**CLOX134080027** C-LOX Screwdriver Shaft 2.7mm

### C-LOX Cages



- CLOX134-0144-08** CLOX Spinal Cage Titan 2.7mm H Plate Almond Cage 14mm x 4
- CLOX134-0146-08** CLOX Spinal Cage Titan 2.7mm H Plate Almond Cage 14mm x 6
- CLOX134-0164-08** CLOX Spinal Cage Titan 2.7mm H Plate Almond Cage 16mm x 4
- CLOX134-0165-10** CLOX Spinal Cage Titan 2.7mm H Plate Almond Cage 16mm x 5
- CLOX134-0166-08** CLOX Spinal Cage Titan 2.7mm H Plate Almond Cage 16mm x 6
- CLOX134-0167-10** CLOX Spinal Cage Titan 2.7mm H Plate Almond Cage 16mm x 7
- CLOX134-0185-10** CLOX Spinal Cage Titan 2.7mm H Plate Almond Cage 18mm x 5
- CLOX134-0187-10** CLOX Spinal Cage Titan 2.7mm H Plate Almond Cage 18mm x 7
- CLOX134-0206-12** CLOX Spinal Cage Titan 2.7mm H Plate Almond Cage 20mm x 6
- CLOX134-0208-12** CLOX Spinal Cage Titan 2.7mm H Plate Almond Cage 20mm x 8

### C-LOX Spinal Cage Locking Screws

Self drilling 2.7mm locking titanium cortex screw with star drive head.

- CLOX245-427-10** CLOX Spinal Cage Locking Screw 12mm (Thread Length 10mm)
- CLOX245-427-12** CLOX Spinal Cage Locking Screw 14mm (Thread Length 12mm)
- CLOX245-427-14** CLOX Spinal Cage Locking Screw 16mm (Thread Length 14mm)
- CLOX245-427-16** CLOX Spinal Cage Locking Screw 18mm (Thread Length 16mm)
- CLOX245-427-18** CLOX Spinal Cage Locking Screw 20mm (Thread Length 18mm)
- CLOX245-427-20** CLOX Spinal Cage Locking Screw 22mm (Thread Length 20mm)

### C-LOX Twist Drill



Anti-skid tip & length matched to C-LOX drill sleeve. AO fitment.

- CLOX148008120** C-LOX 2.0mm AO shaft Twist Drill Bit 100mm Long
- CLOX148008125** C-LOX 2.5mm AO shaft Twist Drill Bit 110mm Long

### C-LOX Locking Drill Guides



Used with 2.0mm drills & 2.7mm screws.

- CLOX164002710** Locking Drill Guide 2.7mm 10mm Working End
- CLOX164002712** Locking Drill Guide 2.7mm 12mm Working End
- CLOX164002714** Locking Drill Guide 2.7mm 14mm Working End
- CLOX164002716** Locking Drill Guide 2.7mm 16mm Working End
- CLOX164002718** Locking Drill Guide 2.7mm 18mm Working End
- CLOX164002720** Locking Drill Guide 2.7mm 20mm Working End

### C-Lox Spinal Disk Broaching Curette



Used for removing disk material & creating bed for cage. 220mm long.

**CLOX134070022** C-LOX Spinal Disk Broaching Curette

### C-Lox Implant Placement Rod



Threaded tip engages with trial cages & with implantable cages. 220mm long.

**CLOX134075022** C-LOX Implant Placement Rod

### C-Lox Distractor



Used to distract the intervertebral disk space. 90mm deep.

**CLOX134075016** C-LOX Distractor 90mm Deep

### Instrumentation

#### Percussion Mallet



Designed for consistent neurological examination.

**001322** Percussion Mallet 180mm Long

#### Rongeurs & Punches

All rongeurs & spine forceps cut with one part of the jaw inserted into the compromised spinal canal.

Our spine instruments are designed to minimise the size of the lower jaw. In many cases this will reduce the cutting strength of the instrument which should only be used on appropriate bone thickness.

A selection of Rongeurs will be required.

#### Duck-Billed Daniel Rongeurs



Designed by Simon Wheeler BVSc PhD, these Rongeurs can remove full thickness laminal bone in small dogs.

They are however, best used to remove the layer of deep cortical bone overlying the spinal cord once the superficial cortex & cancellous bone have been removed using power tools; this is particularly true of the medium & large dog.

**001400** Duck-Billed Daniel Rongeurs 3mm Bite 177mm Long

#### Daniel Rongeur



The jaws of this instrument are straight & the bite is small. Also suitable for bulla osteotomy.

**001402** 4mm Daniels Rongeurs 130mm Cvd

#### Micro Spine Rongeur Set

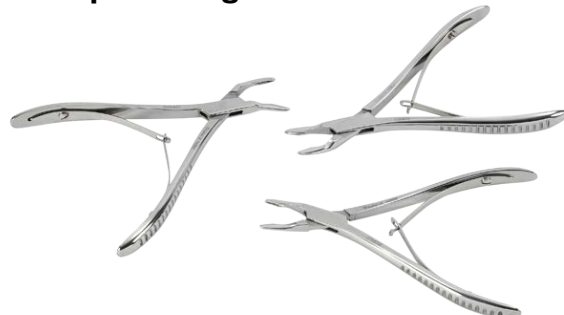

Very fine Rongeurs with a 1.75mm (width) bite. Set contains three variations, straight, curved & angled.

**142600** Micro Spine Rongeurs Set of 3



### ViPP

Through a true partnership approach, you can deliver quantifiable rewards for you and your Practice by joining our **Veterinary Instrumentation Partnership Programme**.

To find out more, scan the QR code below.



**Laminectomy Rongeurs**



These Rongeurs have been developed specifically for Laminectomy in the dog.

- 001432 Laminectomy Rongeurs 2mm 160mm
- 001433 Laminectomy Rongeurs 3mm 160mm

**Lempert Straight**



Useful for spines & bulla osteotomy.

- 6730/10 Lempert Rongeurs Straight 3mm Bite 190mm Long

**Mini-Friedman**



Useful in bulla osteotomy.

- 142501 Mini-Friedman Rongeur Curved 3mm Bite 160mm Long

**Micro-Friedman**



A small spine rongeur.

- 142502 Micro-Friedman Rongeur Curved 2.2mm Bite 155mm Long

**Smith Peterson Compound Rongeurs**



- 142290 Smith Peterson Str Compound Rongeur 24cm 9.5" 3mm Bite

**Compound Action Spinal Rongeurs**



Much more powerful than the Daniels, this instrument can nibble through full thickness lamina. The jaws are very fine & angled to allow the surgeon to enlarge the inter-vertebral foramen.

Available in 2mm, 3mm & 4mm jaw widths. Length 190mm.

- 001429 Compound Action Spinal Rongeurs 2mm
- 001430 Compound Action Spinal Rongeurs 3mm
- 001431 Compound Action Spinal Rongeurs 4mm

**Stille-Luer Rongeurs**



A very large rongeur.

- 142305 Stille-Luer Heavy Compound Action Rongeurs Curved 8mm 225mm Long

**Smith-Kerrison Punch Forceps**



This is a traditional design with a 40 degree upward cutting jaw. Robust spine forceps. 185mm shaft.

- 001143 2mm Self Clearing Kerrisons
- 001445 Smith-Kerrison Punch Forceps 2mm
- 001446 Smith-Kerrison Punch Forceps 3mm

**40° Bone Punch Forceps (Low Profile)**



Designed for use where a high speed bur has removed the outer cortical layer and the underlying cancellous layer, the powerful nibbling action of this device allows very controlled removal of the final layer of cortical bone. The wedge-shaped foot of this device is designed to allow good access whilst still retaining strength, and is polished to minimise friction and potential trauma. Overall length 210mm.

- 001438 Batemans Spine Punch 40 Degree Upward Cut 2mm
- 001439 Batemans Spine Punch 40 Degree Upward Cut 3mm
- 001441 Batemans Spine Punch 40 Degree Upward Cut 4mm

## Retractors & Distractors

### Gelpi Odd Leg Retractor



The asymmetric pattern is most typically used for a dorsal approach to the spine, where the long arm extends deep to retract the longissimus dorsi muscle, as the short arm engages with axial structures. They are supplied in matched, opposite pairs to create a rectangular window of exposure.

001333 Gelpi Self Retaining Retractors Odd Leg 205mm Pair  
001334 Gelpi Self Retaining Retractors Odd Leg 130mm Pair

### Spike & Shield Odd Leg Retractor



Operates in a similar fashion to the odd leg Gelpis but the muscle retaining shield creates a wider field of view. Supplied in pairs left & right.

001480 Large 25 x 25mm Shield 180mm Long - Pair

### Cone Laminectomy Retractor



Similar in size to a Travers retractor but with articulated arms, the cone retractor allows a very flexible field of retraction, with the additional benefit that it can be folded away from the operation site. Maximum retraction, minimum interference.

001335 Cone Laminectomy Retractor 160mm Long

### Small Spine Distractor



The tips of the small distractor are designed to fit into inter-vertebral spaces. The surfaces pushing against the end plates are serrated for maximum grip. Tips when closed 4mm. Overall length 140mm. Tips are staggered for easy introduction.

001491 Small Spine Distractor

### McKee Distractor With Speedlock



The odd legs of this dedicated distractor engage the inter-vertebral space cranial to & caudal to the space involved.

The speedlock opens the disc space leaving it uncluttered by instrumentation.

090257 McKee Distractor With Speedlock 240mm

### FitzExcavator Set



Designed & developed by Noel Fitzpatrick this excavator set includes all the necessary hand instruments for surgical management of canine inter-vertebral disc disease.

The set consists of 5 cutting instruments: one left, one right, plus 3 straight instruments 2.00mm, 1.00mm & 0.5mm.

Set also includes 001275 Molt Periosteal Elevator (4mm/6mm).

The six instruments are supplied in a stainless autoclavable case.

001428 FitzExcavator Set

## Hand Instruments

### Periosteal Elevator Very Fine



001272 Periosteal Elevator Very Fine 2mm/3mm 180mm Long

### Dandy Nerve Hook



The Dandy nerve hook is useful for manipulation of nerves & nerve roots. Also useful for manipulation of the medial meniscus during CCL procedures.

001408 Dandy Nerve Hook 1mm 190mm Long  
001409 Dandy Nerve Hook 2mm 220mm Long

### Freer Periosteal Elevator



The Freer elevator is a fine instrument which is particularly useful in spinal work.

7350/05 Freer Periosteal Elevator 5mm 180mm Long

### Chase Spinal Hook

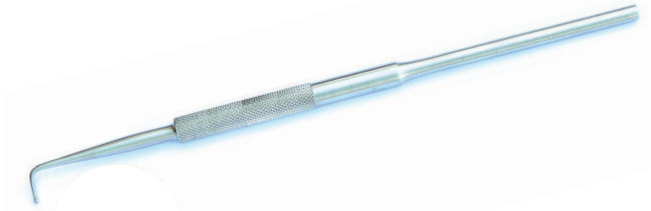

Based on a suggestion from Damian Chase. This probe is useful for manipulation of the spinal cord & nerve roots during certain surgeries.

001451 Chase Spinal Hook 8mm 90° Offset 145mm Long

### Bone Curette



Following requests for a House curette with smaller scoops. This is the smallest scoop we can provide whilst still being strong enough to elevate bone.

001412 Bone Curette 2.0mm Scoop 145mm Long

### House Curette



The House curette is a strong small curette to lift bone from around the spinal cord. Double ended 2.5mm & 3.0mm scoops.

7262/05 House Curette 2.5 & 3.0mm Scoops 150mm

### Rosen Mobiliser



With care, intraneural canal structures can be manipulated. Removal of disc debris is essential to achieve decompression of the cord. The curved tip of this instrument is very useful.

7105/40S Rosen Mobiliser No.8 160mm

## Sheas Curette



Fenestration of discs, particularly cervical discs, can be a useful procedure. The Sheas Curette is a very small scoop. 2.5mm in diameter.

**001410** Sheas Disc Curette 2.5mm Diameter 170mm

## Younger Good Scaler Jaquette Scaler

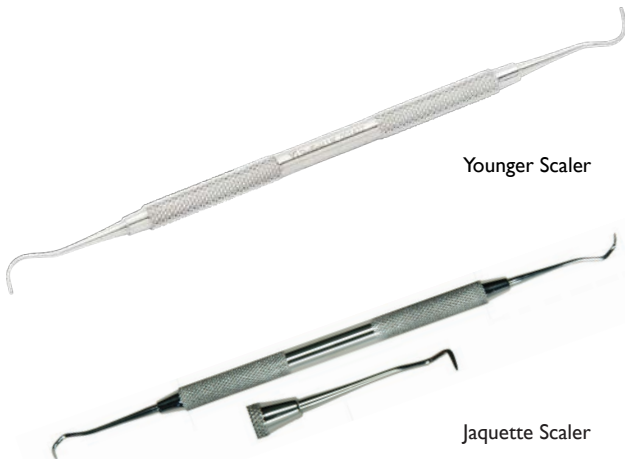

Younger Scaler

Jaquette Scaler

Both instruments are recommended by Simon Wheeler for the removal of wafer thin bone overlying the spinal cord during Laminectomy.

The Younger Good scaler is blunt-backed & useful for removal of disc material from both disc spaces & neural canal. This is not a standard scaler in that all the sharp surfaces are softened to minimise spinal trauma.

The Jaquette scaler is sharp & best suited to hooking out the final lamina.

**001422** Younger Good Scaler 175mm

**001424** Small Jaquette Scaler 165mm

## Spinal Needles



- 405255** 22g x 3" Spinal Needles Disposable Box of 25
- 405253** 20g x 3.5" Spinal Needles Disposable Box of 25
- 405252** 20g x 3" Spinal Needles Disposable Box of 25
- 012502** Spinal Needle 21g Short Bevel 25mm Reusable
- 012500** Spinal Needle 19g Short Bevel 38mm Reusable
- J0529AN** Jorvet Spinal Needle 18g x 6

## Bone Wax



It will not help you if you hit a venous sinus but will control the blood from cut cancellous bone which obscures the visual field. The wax physically blocks the blood vessels.

**001460** Bone Wax 12 x 2.5g

## Veterinary Instrumentation Bone Cement



Bone cement can be used for stabilising spinal fractures. Use screws or pins to provide 'keying' points.

Can also be used for distraction of the disc space using a small screw & filling the space with Gentamycin BCIG Bone Cement.

- BCI** High Viscosity - 40 Grams
- BC1G** High Viscosity With 20 Grams Gentamycin
- BC3G** Low Viscosity (Syringe) With 20 Grams Gentamycin

## Lyostypt®



Lyostypt® is a wet-stable collagen haemostat. Collagen leads to thrombocyte adhesion & to activation of coagulation factor XII. 30 x 50mm. 12 units per pack.

- Achieves haemostatis very swiftly
- Is completely absorbable
- Can be removed easily
- Can be applied endoscopically
- Can be combined with fibrin glue & antibiotics

**1069128** Lyostypt® (12 Units)



# VETIGEL®

Exclusively available from Vi®

VETIGEL® is a haemostatic gel that is designed to stop moderate to severe bleeding within seconds. VETIGEL® helps control bleeding in animals by achieving haemostasis in seconds without the need for manual pressure.

VETIGEL® can be used on a variety of procedures, including but not limited to: dental extractions, oral mass removals, abdominal and thoracic mass removals, soft organ biopsies, enucleations, spays & neuters, amputations, venous & arterial bleeds, cholecystectomies, catheterisation, and lacerations.

## VETIGEL® Haemostatic Gel



**VET-02** VETIGEL Haemostatic Gel 2 x 5ml

**VET-05** VETIGEL Haemostatic Gel 5 x 5ml

## VETIGEL® Accessory Packs



**ACC-01** VETIGEL Haemostatic Gel 2 x Accessory Packs



# General Surgical



To view the General Surgical section of our website, please scan the QR code:



### Vi General Surgery Kit



Vi surgical instrument kits contain specifically selected high quality instrumentation for your small animal surgical needs.

The Vi General Surgery Kit contains:

584760	Mayo Needle Holder 140mm	x1
746100	Metzenbaum Scissors - Straight 145mm	x1
745300	Mayo Scissors Chamf Blades 140mm	x1
106625	Spencer Wells Artery Forceps - Curved 125mm	x2
106600	Spencer Wells Artery Forceps - Straight 125mm	x2
103175	Halstead Mosquito Forceps 125mm	x2
342005	Debakey Atraumatic Dissecting Forceps 150mm	x1
341200	Adson Serrated Dissecting Forceps 125mm	x1
341145	Dissecting Forceps 1/2 Teeth 150mm	x1
0803	Scalpel Handle No 3	x1
171566	Jones Cross Action Towel Clips	x4

**VIGSKIT** Vi General Surgery Kit

### Vi General Surgery Kit - Left Handed



The Vi General Surgery Left Handed Kit contains:

171566	Jones Cross Action Towel Clips	x4
746100L	Metzenbaum Scissors - Straight 145mm - Left Handed	x1
745300L	Mayo Scissors Chamf Blades 140mm - Left Handed	x1
341145	Dissecting Forceps 1/2 Teeth 150mm	x1
106625L	Spencer Wells Artery Forceps - Cvd 125mm - Left Handed	x2
106600L	Spencer Wells Artery Forceps - Str 125mm - Left Handed	x2
103175L	Halstead Mosquito Forceps 125mm Left Handed	x2
342005	Debakey Forceps 150mm	x1
341200	Adson Serrated Dissecting Forceps 125mm	x1
585400L	Olsen Hegar Needle Holders - Left Handed	x1
0803	Scalpel Handle No 3	x1

**VIGSKIT-L** Vi General Surgery Kit Left Handed

### Vi Basic Surgery Stitch Up Kit



Vi Basic Surgery Stitch Up Kit contains high quality instrumentation for your stitch up procedures.

The Vi basic surgery stitch up kit contains:

584760	Mayo Needle Holder 140mm	x1
745300	Mayo Scissors Chamf Blades 140mm	x1
106600	Spencer Wells Artery Forceps - Straight 125mm	x2
346850	Treves 1/2 Teeth Dissecting Forceps 125mm	x1
0803	Scalpel Handle No 3	x1

**VIBSSKIT** Vi Basic Surgery Stitch Up Kit

### Left Handed Instrument Starter Kit



Vi offer a selection of left handed instruments, identified by one black handle.

The Left Handed Instrument Starter Kit contains:

585400L	Olsen Hegar Needle Holders - Left Handed	x1
745300L	Mayo Scissors Str 140mm - Left Handed	x1
746200L	Metzenbaum Scissors Str 145mm - Left Handed	x1
746110L	Metzenbaum Scissors Str 180mm - Left Handed	x1
103175L	Halstead Forceps Str 125mm - Left Handed	x2
103225L	Halstead Forceps Cof 125mm - Left Handed	x2
101780L	Crile Forceps Cof 140mm - Left Handed	x4
841350L	Backhaus Towel Clips - Left Handed	x4
341210	Adson Serrated Dissecting Forceps 125mm	x1
342005	Debakey Forceps 150mm	x1
0803	Scalpel Handle No 3	x1
BX201040	Stainless Steel Box 200mm X 100mm X 40mm	x1

**LHKIT** Left Handed Instrument Starter Kit

### Left Handed Feline Spay Kit



The Vi Left Handed Feline Spay Kit contains:

BX201040	Instrument Box 200x100x40mm	x1
103225L	Halstead Forceps Cof 125mm - Left Handed	x2
014211	Spay Forceps 125mm	x1
341210	Adson Serrated Dissecting Forceps 125mm	x1
585400L	Olsen Hegar Needle Holders - Left Handed	x1
171566	Jones Cross Action Towel Clips	x2
106625L	Spencer Wells Artery Forceps - Cvd 125mm - Left Handed	x2
746101L	Metzenbaum Scissors Str 150mm - Left Handed	x2
0830	Scalpel Handle No 3	x1

**SPAYFEL-L** Cased Feline Spay Kit Left Handed

### Left Handed Canine Spay Kit



The Vi Left Handed Canine Spay Kit contains:

BX221550	Instrument Box 220x150x50mm	x1
BXSIL2215	Silicone Insert For Instrument Box 220x150x50mm	x1
745300L	Mayo Scissors Chamf Blades 140mm - Left Handed	x1
171566	Jones Cross Action Towel Clips	x4
014307L	Carmault Forceps 200mm Cvd Left Handed	x2
341145	Dissecting Forceps 1/2 Teeth 150mm	x1
106630L	Spencer Wells Artery Forceps 150mm Cvd Left Handed	x4
801155L	Allis Tissue Forceps 3/4 Teeth 150mm	x2
605355L	Olsen Hagar TC Needleholder 165mm Left Handed	x1
0830	Scalpel Handle No 3	x1

**SPAYCAN-L** Cased Canine Spay Kit Left Handed



### Loan Kits

For a nominal fee, we have a range of **specialist loan kits** available to complement your own fleet. With next working day availability, the service offers flexibility as procedures are booked with your clients.

To find out more, scan the QR code below.



## Artery Forceps

### Spencer Wells



Standard veterinary artery forceps.

<b>106600</b>	Spencer Wells Artery Forceps Str 12.5cm 5"
<b>106605</b>	Spencer Wells Artery Forceps Str 15cm 6"
<b>106610</b>	Spencer Wells Artery Forceps Str 18cm 7"
<b>106615</b>	Spencer Wells Artery Forceps Str 20cm 8"
<b>106620</b>	Spencer Wells Artery Forceps Str 23cm 9"
<b>106621</b>	Spencer Wells Artery Forceps Str 30cm 12"
<b>106625</b>	Spencer Wells Artery Forceps Cof 12.5cm 5"
<b>106630</b>	Spencer Wells Artery Forceps Cof 15cm 6"
<b>106635</b>	Spencer Wells Artery Forceps Cof 18cm 7"
<b>106640</b>	Spencer Wells Artery Forceps Cof 20cm 8"
<b>106645</b>	Spencer Wells Artery Forceps Cof 23cm 9"

### Halstead Mosquito



Very light but adequate for routine haemostasis in all but the largest blood vessels.

<b>103165</b>	Halstead Mosquito Artery Forceps Str 10cm 4"
<b>103170</b>	Halstead Mosquito Artery Forceps Cof 10 cm 4"
<b>103175</b>	Halstead Mosquito Artery Forceps Str 12.5cm 5"
<b>103225</b>	Halstead Mosquito Artery Forceps Cof 12.5cm 5"
<b>103180</b>	Halstead Mosquito Artery Forceps 1/2 Teeth Str 12.5cm 5"
<b>103185</b>	Halstead Mosquito Artery Forceps 1/2 Teeth Cof 12.5cm 5"

### Kocher



Similar to Rochester Peans, but with a 1/2 toothed tip for added security.

<b>105520</b>	Kocher Artery Forceps Cof 14cm 5.5"
<b>105521</b>	Kocher Artery Forceps Str 15cm 6"
<b>105522</b>	Kocher Artery Forceps Cof 15cm 6"

### Rochester Pean



Long jaw forceps, useful as a hysterectomy clamp in cats & small-medium breed bitches.

<b>106225</b>	Rochester Pean Artery Forceps Str 14cm 5.5"
<b>106230</b>	Rochester Pean Artery Forceps Str 16cm 6.5"
<b>106235</b>	Rochester Pean Artery Forceps Str 18cm 7"
<b>106236</b>	Rochester Pean Artery Forceps Str 22cm 8.5"
<b>106270</b>	Rochester Pean Artery Forceps Cof 14cm 5.5"
<b>106275</b>	Rochester Pean Artery Forceps Cof 16cm 6.5"
<b>106280</b>	Rochester Pean Artery Forceps Cof 18cm 7"
<b>106285</b>	Rochester Pean Artery Forceps Cof 20cm 8"
<b>106290</b>	Rochester Pean Artery Forceps Cof 22cm 9"

### Crile



Jaw is somewhat lighter than the more popular Spencer Wells Artery Forceps.

<b>101750</b>	Crile Artery Forceps Str 14cm 5.5"
<b>101755</b>	Crile Artery Forceps Atraumatic Jaws Str 14cm 5.5"
<b>101765</b>	Crile Artery Forceps Str 16cm 6.5"
<b>101775</b>	Crile Artery Forceps Str 18cm 7"
<b>101780</b>	Crile Artery Forceps Cof 14cm 5.5"
<b>101785</b>	Crile Artery Forceps Atraumatic Jaws Cof 14cm 5.5"
<b>101795</b>	Crile Artery Forceps Cof 16cm 6.5"
<b>101800</b>	Crile Artery Forceps Cof 18cm 7"

### Negus Forceps



<b>7018/05</b>	Negus Artery Forceps Small Cof 18cm 7"
----------------	--

### Kelly



<b>106700</b>	Kelly Artery Forceps Curved 14cm 5.5"
<b>106710</b>	Kelly Artery Forceps Straight 14cm 5.5"

## Dieffenbach (Bulldog) Clamps



Small Cross Action Vascular Clamps. Most commonly used in soft tissue surgery.

- 107708** Dieffenbach (Bulldog) Clamp Str 5cm
- 107710** Dieffenbach (Bulldog) Clamp Cof 5cm

## Mayo Safety Pin



Use to organise artery forceps & other similar instruments.

- 106699** Mayo Safety Pin

## Ramplays Sponge Forceps



- 786505** Ramplays Sponge Forceps 25cm

## Tissue Forceps

### Allis



- 801150** Allis 2/3 Teeth 15cm 6"



- 801160** Allis 4/5 Teeth 15cm 6"



- 801165** Allis 5/6 Teeth 15cm 6"



- 801170** Allis 6/7 Teeth 15cm 6"

General purpose tissue forceps.

- 801150** Allis Tissue Forceps 2/3 Teeth 15cm 6"
- 801155** Allis Tissue Forceps 3/4 Teeth 15cm 6"
- 801156** Allis Tissue Forceps 3/4 Teeth 18cm 7"
- 801160** Allis Tissue Forceps 4/5 Teeth 15cm 6"
- 801161** Allis Tissue Forceps 4/5 Teeth 20cm 8" Angled
- 801165** Allis Tissue Forceps 5/6 Teeth 15cm 6"
- 801170** Allis Tissue Forceps 6/7 Teeth 15cm 6"
- 801175** Baby Allis Tissue Forceps 4/5 Teeth 13cm 5"

### Babcock



An alternative to Allis. Less traumatic but less grip.

- 801350** Babcock 16.5cm 6.5"
- 801354** Babcock 18cm 7"
- 801355** Babcock 20cm 8"
- 801360** Babcock 23cm 9"

## Youngs Tongue Forceps



- 7853/05** Youngs Tongue Forceps 17cm 6.5"
- 7853/05SPARE** Young Tongue Forceps Spare Rubbers 1 Pair

## Scalpel Blades & Handles

### Swann Morton Handles



- 0803 Scalpel Handle No 3
- 0804 Scalpel Handle No 4
- 0807 Scalpel Handle No 7
- 0814 Scalpel Handle No 4L
- 0909 Scalpel Handle No 9
- 0923 Scalpel Handle No B3
- 02652 PM40 Standard Handle

### Beaver Type Handle



- 06054 Vi Fine Beaver Type Scalpel Handle 130mm
- 06051 Fine Stainless Steel Beaver Type Scalpel Handle 130mm
- 06052 Fine Stainless Steel Beaver Type Scalpel Handle 100mm
- 06053 Fine Stainless Steel Beaver Type Scalpel Handle 80mm

### Swann Morton Scalpel Blades



- 0201 Carbon Sterile Blades 10
- 0203 Carbon Sterile Blades 11
- 0204 Carbon Sterile Blades 12
- 0205 Carbon Sterile Blades 15
- 0207 Carbon Sterile Blades 21
- 0208 Carbon Sterile Blades 22
- 0210 Carbon Sterile Blades 23
- 0211 Carbon Sterile Blades 24
- 02551 PM40 Standard Blade Box of 10

### Swann Morton Fine Blades Beaver Type



- 05901 Fine Stainless Steel Blades SM61 Box of 25
- 05902 Fine Stainless Steel Blades SM62 Box of 25
- 05903 Fine Stainless Steel Blades SM63 Box of 25
- 05904 Fine Stainless Steel Blades SM64 Box of 25
- 05905 Fine Stainless Steel Blades SM65 Box of 25
- 05906 Fine Stainless Steel Blades SM65A Box of 25
- 05907 Fine Stainless Steel Blades SM67 Box of 25
- 05908 Fine Stainless Steel Blades SM68 Box of 25
- 05909 Fine Stainless Steel Blades SM69 Box of 25

### Scapel Blade Removers

- 240109 Scalpel Blade Removing Forceps
- 5525 Scalpel Blade Remover Box of 10

Scalpel Handles & Blades			
Code	Scalpel Size	Handle Length	Blade Size
0803	No. 3 Handle with Scale	12cm	10, 11, 12, 15
0923	No. B3 Handle	12.8cm	10, 11, 12, 15
0807	No. 7 Handle	16cm	10, 11, 12, 15
0909	No.9 Handle	11.6cm	10, 11, 12, 15
0804	No. 4 Handle	13cm	21, 22, 23, 24
0814	No. 4 Long Handle	21cm	21, 22, 23, 24

## Surgical Scissors

Surgical scissors are typically either one of two designs. The Mayo is the general purpose surgical scissor in which the blade occupies approximately one third of the length of the scissor. The 14cm straight Mayo is the standard veterinary surgical scissor. The Metzenbaum is a finer, lighter scissor in which the blade occupies approximately one quarter of the scissor length. Using a 14.5cm Metzenbaum rather than a 14cm Mayo will give you a finer scissor but a similar working distance.

Each style of scissor is available in four different versions which vary according to blade construction & cutting characteristics. They can be identified by handle colour.

- Standard: Stainless - silver-coloured throughout
- Supercut: Black handles
- Tungsten Carbide: Gold handles
- Supercut T.C.: One black handle, one gold handle

### Surgical Scissor - Mayo



The Mayo is a general purpose surgical scissor.

<b>745300</b>	Mayo Chamf Blades Str 14cm 5.5"
<b>745310</b>	Mayo Chamf Blades Str 16.5cm 6.5"
<b>745320</b>	Mayo Chamf Blades Str 19cm 7.5"
<b>745330</b>	Mayo Chamf Blades Str 21.5cm 8.5"
<b>745400</b>	Mayo Chamf Blades Cof 14cm 5.5"
<b>745410</b>	Mayo Chamf Blades Cof 16.5cm 6.5"
<b>745420</b>	Mayo Chamf Blades Cof 19cm 7.5"
<b>745430</b>	Mayo Chamf Blades Cof 21.5cm 8.5"

### Surgical Scissor - Metzenbaum



The Metzenbaum is a finer lighter scissor than the Mayo.

<b>746100</b>	Metzenbaum Scissor Str 14.5cm 5.75"
<b>746101</b>	Metzenbaum Scissor Str 15cm 6"
<b>746110</b>	Metzenbaum Scissor Str 18cm 7"
<b>746115</b>	Metzenbaum Scissor Str 20.5cm 8"
<b>746130</b>	Metzenbaum Scissor Str 23cm 9"
<b>746200</b>	Metzenbaum Scissor Cof 14.5cm 5.75"
<b>746210</b>	Metzenbaum Scissor Cof 18cm 7"
<b>746215</b>	Metzenbaum Scissor Cof 20.5cm 8"
<b>746230</b>	Metzenbaum Scissor Cof 23cm 9"

### Surgical Scissor - Supercut



One blade is sharpened to a tapered edge which greatly enhances the ability of the scissor to slice through tissues. The standard scissor has much more of a crushing action. Identified by having black handles.

<b>760000</b>	Mayo Supercut Str 14cm 5.5"
<b>760002</b>	Mayo Supercut Cof 14cm 5.5"
<b>760008</b>	Metzenbaum Supercut Str 14.5cm 5.75"
<b>760009</b>	Metzenbaum Supercut Cof 14.5cm 5.75"
<b>760010</b>	Metzenbaum Supercut Str 18cm 7"
<b>760012</b>	Metzenbaum Supercut Cof 18cm 7"

### Surgical Scissors - Tungsten Carbide



Tungsten carbide cutting edges give long service life between sharpening. Gold handles distinguish these from standard scissors.

<b>752250</b>	Mayo Clinical Hard Edge Str 15cm 6"
<b>752260</b>	Mayo Clinical Hard Edge Str 18cm 7"
<b>752280</b>	Mayo Clinical Hard Edge Cof 15cm 6"
<b>752290</b>	Mayo Clinical Hard Edge Cof 18cm 7"
<b>754020</b>	Metzenbaum Hard Edge Str 14.5cm 5.75"
<b>754030</b>	Metzenbaum Hard Edge Str 18cm 7"
<b>754060</b>	Metzenbaum Hard Edge Str 23cm 9"
<b>754080</b>	Metzenbaum Hard Edge Cof 14.5cm 5.75"
<b>754090</b>	Metzenbaum Hard Edge Cof 18cm 7"
<b>754120</b>	Metzenbaum Hard Edge Cof 23cm 9"
<b>754050</b>	Metzenbaum Fino TC Cof 22cm 8.5"
<b>754095</b>	Metzenbaum Hard Edge Cof 35cm 14"

**Surgical Scissor - Supercut T.C.**



Combining the hard wearing characteristics of tungsten carbide with supercut tapered edges to provide a very fine cut & long interval between sharpening.

- 76000TC** Mayo Supercut T.C. Str 14cm 5.5"
- 760002TC** Mayo Supercut T.C. Cof 14cm 5.5"
- 760008TC** Metzenbaum Supercut T.C. Str 14.5cm 5.75"
- 760009TC** Metzenbaum Supercut T.C. Cof 14.5cm 5.75"
- 760010TC** Metzenbaum Supercut T.C. Str 18cm 7"
- 760012TC** Metzenbaum Supercut T.C. Cof 18cm 7"
- 760014TC** Metzenbaum Supercut T.C. Cof Fine 18cm 7"

**Cosmetic Surgeon Scissors**



Favoured by human cosmetic surgeons, these scissors have very fine razor-sharp blades with tungsten carbide inserts for long life. They have a beautiful action & a place in veterinary surgery where precise cutting is required, especially for fine skin.

- 755100** Cosmetic Surgeon Scissors T.C. Str 15cm 6"

**General Scissors**

**Dressing - Blunt/Blunt**



- 742610** Dressing Scissors Blunt Str 12.5cm 5"
- 742620** Dressing Scissors Blunt Str 14cm 5.5"
- 742630** Dressing Scissors Blunt Str 15cm 6"
- 742640** Dressing Scissors Blunt Str 18cm 7"
- 742900** Dressing Scissors Blunt Cof 12.5cm 5"
- 742622** Dressing Scissors Blunt Cof 14cm 5" Serrated
- 742910** Dressing Scissors Blunt Cof 14cm 5.5"
- 742920** Dressing Scissors Blunt Cof 15cm 6"
- 742930** Dressing Scissors Blunt Cof 18cm 7"

**Dressing - Blunt/Blunt Coloured Handles**



These standard dressing scissors are available with different coloured handles for easy identification.

- 742622G** Dressing Scissors Serr B/B Cof Gold Handles 12.5cm 5"
- 742622B** Dressing Scissors Serr B/B Cof Blue Handles 12.5cm 5"
- 742622RB** Dressing Scissors Serr B/B Cof Rainbow Handles 12.5cm 5"
- 742622P** Dressing Scissors Serr B/B Cof Purple Handles 12.5cm 5"

**Dressing - Sharp/Sharp**



- 742600** Dressing Scissors Sharp Str 10cm 4"
- 742700** Dressing Scissors Sharp Str 11cm 4.5"
- 742710** Dressing Scissors Sharp Str 13cm 5"
- 742720** Dressing Scissors Sharp Str 14cm 5.5"
- 742730** Dressing Scissors Sharp Str 15cm 6"
- 742740** Dressing Scissors Sharp Str 18cm 7"
- 743010** Dressing Scissors Sharp Cof 12.5cm 5"

**Dressing - Blunt/Sharp**



- 742810** Dressing Scissors Blunt/Sharp Str 12.5cm 5"
- 742820** Dressing Scissors Blunt/Sharp Str 15cm 6"
- 743100** Dressing Scissors Blunt/ Sharp Cof 12.5cm 5"
- 743120** Dressing Scissors Blunt/ Sharp Cof 15cm 6"



## Bandage Scissors

### Veterinary Bandage Scissors



Lower profile & slightly straighter than standard Lister bandage scissors, to better fit veterinary patients. Listers are often too bulky, as they are designed for larger human patients.

**744820** Veterinary Bandage Scissors 14cm 5.5"  
**744830** Veterinary Bandage Scissors 19cm 7.5"

## Lister Bandage



**744800** Lister Bandage Scissor 14.5cm 5.5"  
**744810** Lister Bandage Scissor 18cm 7"

## General Purpose Dressing Scissors



The comfortable handles & serrated blades make these a useful all round dressing scissor inexpensive enough for each consulting room.

**744840** General Purpose Dressing Scissors 19cm 7.5"

## Stitch Cutters

### Heath Stitch



General purpose stitch cutter.

**743800** Heath Stitch Scissors 15cm 6"

## Littauer Stitch



Very nice for removal of small awkward sutures.

**745095** Littauer Stitch Scissors 9cm 3.5"  
**745100** Littauer Stitch Scissors 11cm 4.5"  
**745110** Littauer Stitch Scissors 12.5cm 5"

## Castroviejo Suture Removal Scissors



Designed for the removal of very fine sutures. The Castroviejo action matches that of the Castroviejo Needle Holders.

**014185** Castroviejo Suture Removal Scissors 12cm 4.5"

## Needle Holders

Dedicated needleholders offer the best grip, and dedicated suture scissors offer the best cutting action. However combined needleholder/scissors are very popular for convenience in spite of the functional compromise. Most Vi needleholders are available with tungsten carbide jaw inserts. These grip & wear better. Particularly useful for smaller needles. Identified by gold handles.

### Olsen Hegar Scissor/Needle Holder



Olsen Hegars are usually considered the 'go to' choice for general surgery. Highly recommended. Combined scissor/needle holder.

585400	Olsen Hegar Needle Holders 14cm 5.5"
585410	Olsen Hegar Needle Holders 16.5cm 6.5"
585420	Olsen Hegar Needle Holders 19cm 7.5"
605340	Olsen Hegar Needle Holders T.C. Jaws 11.5cm 4.5"
605350	Olsen Hegar Needle Holders T.C. Jaws 14cm 5.5"
605350S	Olsen Hegar Needle Holders 'S' Cut T.C. Jaws 14.5cm 5.5"
605355	Olsen Hegar Needle Holders T.C. Jaws 16.5cm 6.5"
605380	Olsen Hegar Needle Holders 'S' Cut T.C. Jaws 16cm 6"
605385	Olsen Hegar Needle Holders 'S' Cut T.C. Jaws 18cm 7"
605390	Olsen Hegar Needle Holders 'S' Cut T.C. Jaws 19cm 7.5"
605360	Olsen Hegar Needle Holders T.C. Jaws 19cm 7.5"
605361	Olsen Hegar Needle Holders Razor Cut 14.5cm 5.5"
605362	Olsen Hegar Needle Holders Razor Cut 17cm 6.5"

### Mayo & Mayo Hegar (T.C.)



Veterinary general purpose needleholder, available in a wide range of sizes with or without tungsten carbide jaw inserts. Mayo Hegar is the TC variant of standard Mayo.

584750	Mayo Needle Holders 12.5cm 5"
584760	Mayo Needle Holders 14cm 5.5"
584780	Mayo Needle Holders 16.5cm 6.5"
584765	Mayo Needle Holders 18cm 7.0"
584820	Mayo Needle Holders 20cm 8"
604700	Mayo Hegar T.C. Jaws 12.5cm 5"
604705	Mayo Hegar T.C. Jaws 14cm 5.5"
604715	Mayo Hegar T.C. Jaws 16cm 6"
604715L	Mayo Hegar T.C. Jaws - Left Handed 16cm 6"
604720	Mayo Hegar T.C. Jaws 18.5cm 7"
604735	Mayo Hegar T.C. Jaws 20cm 8"
604740	Mayo Hegar T.C. Jaws 23cm 9"

### DeBakey Needle Holders



Much lighter in construction than the Mayo Hegar. These needleholders are very useful for deep surgical procedures where there is limited space e.g. chest surgery.

602005	DeBakey Needle Holders T.C. Jaws 18cm 7"
602010	DeBakey Needle Holders T.C. Jaws 20cm 8"
602030	DeBakey Needle Holders T.C. Jaws 22.5cm 8.5"
602015	DeBakey Needle Holders T.C. Jaws 23cm 9"
602020	DeBakey Needle Holders T.C. Jaws 25cm 10"
602025	DeBakey Needle Holders T.C. Jaws 30.5cm 12"

### McPhails



The McPhails needle holder has one soft copper jaw for extra needle grip, the other is stainless steel. The catch engages with a moderate squeeze on the handles. Further pressure releases the catch & the needle.

584650	McPhails Needle Holders 15cm 6"
584660	McPhails Needle Holders 18cm 7"
584670	McPhails Needle Holders 20cm 8"

### Gillies



Combined scissor/needle holder. No ratchet.

582950	Gillies Needle Holders RH 16cm 6.25"
582951	Gillies Needle Holders LH 16cm 6.25"
602950	Gillies Needle Holders T.C. Jaws RH 16cm 6.25"
602951	Gillies Needle Holders T.C. Jaws LH 16cm 6.25"

## Foster Gillies



Smaller than the standard Gillies this instrument is useful for finer surgery or smaller hands.

- 582650 Foster Gillies Needle Holders RH 12.5cm 5"
- 582660 Foster Gillies Needle Holders LH 12.5cm 5"
- 602700 Foster Gillies Needle Holders T.C. Jaws RH 12.5cm 5"
- 602705 Foster Gillies Needle Holders T.C. Jaws LH 12.5cm 5"

## Miniature Foster Gillies



- 602710 Miniature Foster Gillies T.C. 10cm 4"

## Castroviejo



Classic ophthalmic needleholder with catch. Infrequent ophthalmic surgeons should also consider Miniature Fosters or Ryders as the squeeze action of Castroviejos requires patience & practice to master. Also available without catch.

- 014175 Castroviejo Needle Holders With Catch T.C. 15cm 6"
- 014177 Castroviejo Needle Holders Without Catch T.C. 15cm 6"

## Castroviejo Needle Holders/Scissor



This Instrument functions as a standard Castroviejo needleholder but the jaws incorporate a suture cutting function in the style of Olsen Hegars or Gillies. Jaws are tungsten carbide for maximum grip.

- 014181 Castroviejo Needle Holders/Scissor Str T.C. 15cm 6"
- 014182 Castroviejo Needle Holders/Scissor Cof T.C. 15cm 6"
- 014183 Castroviejo Needle Holders/Scissor Str 'S'Cut T.C. 15cm 6"
- 014184 Castroviejo Needle Holders/Scissor Cof 'S'Cut T.C. 15cm 6"

## Kilner Needle Holders



Kilner needle holders are similar to 140mm Mayos but the arms are cranked, offsetting the jaws from the handles by around 10mm.

- 608000 Kilner Needle Holders 14cm 5.5"

## Ryder Needle Holders



Ideal for small needles. The smaller sizes are an alternative for ophthalmic needleholders.

- 606340 Ryder (Micro) T.C. Jaws 12.5cm 5"
- 606345 Ryder (Micro) T.C. Jaws 15cm 6"
- 606350 Ryder (Micro) T.C. Jaws 18cm 7"

## Derf Needle Holder



The Derf needle holder is a small T.C. needleholder with slightly heavier jaws than the Ryder. More resistant to surgeon abuse!

- 607010 Derf Needle Holder T.C. Jaws 12cm 5"

## Galibans Suture Forceps



Use when placing sutures under tension. A good example is the placement of a lateral stabilising suture in the management of cranial cruciate ligament failure or abdominal sutures in an overweight dog. Galibans used by an assistant are used to atraumatically secure the first throw. The Galibans are removed as the second throw is tightened.

- 58900 Galibans Suture Holding Forceps

## Towel Clips

### Backhaus Towel Clip



- 841350 Backhaus 9cm 3.5"
- 841355 Backhaus 10cm 4"
- 841360 Backhaus 12.5cm 5"

### Cross Action Towel Clips



- 846550 Shardel Cross Action 9cm 3.5"



- 171566 Jones Cross Action 9cm 3.5"

### Atraumatic Towel Clip



Non puncturing but will bruise if not used with care

- 841352 Atraumatic Towel Clip 10cm 4.5"

### Ball & Socket Towel Clamp



Designed for use on drapes only, for drape to drape anchorage. Less likely to cause tears, particularly with disposable drapes.

- 843005 Ball & Socket Towel Clamp 12.5cm 5"

## Dissecting Forceps

### Serrated-Block End



General purpose dissecting forceps.

- 341070 Block End Serrated Dissecting Forceps 12.5cm 5"
- 341075 Block End Serrated Dissecting Forceps 15cm 6"
- 341080 Block End Serrated Dissecting Forceps 18cm 7"
- 347655 Dressing Forceps 20.5cm 8"

### Treves Rat Tooth Forceps



General purpose rat tooth dissecting forceps.

- 346850 Treves Dissecting Forceps 1/2 Teeth 12.5cm 5"
- 346855 Treves Dissecting Forceps 1/2 Teeth 15cm 6"
- 346860 Treves Dissecting Forceps 1/2 Teeth 18cm 7"
- 347665 Fine Rat Tooth Thumb Forceps 20.5cm 8"

### Dissecting Forceps 1/2 Teeth



- 341145 Dissecting Forceps 1/2 Teeth 15cm 6"
- 341160 Dissecting Forceps 1/2 Teeth 18cm 7"
- 341170 Lanes Dissecting Forceps 1/2 Teeth 6" 15cm
- 349520 Lanes Dissecting Forceps 2/3 Teeth 7" 18cm

### Connective Tissue Forceps



DeBakey-style handles with Adson Brown tips, providing excellent grip of connective tissue with minimal trauma.

- 343001 Connective Tissue Forceps 15.3cm 6"
- 343002 Connective Tissue Forceps 18cm 7"

## Adson



Ideal for fine surgical procedures. Available in a range of jaw designs.

<b>341200</b>	Adson Serrated Dissecting Forceps 12.5cm 5"
<b>341201</b>	Adson Serrated Extra Fine 12.5cm 5"
<b>341210</b>	Adson Dissecting Forceps 1/2 Teeth 12.5cm 5"
<b>341212</b>	Adson Brown Dissecting Forceps 12.5cm 5"
<b>341214</b>	Adson Brown Serrated/ Crocodile 15cm 6"
<b>341215</b>	Adson Brown 1/2 Teeth 15cm 6"
<b>341220</b>	Adson DeBaKey Dissecting Forceps 12.5cm 5"

## DeBaKey - Atraumatic



Originally designed for cardiovascular surgery, these forceps grip firmly with minimal damage to delicate tissue, including bowel & urogenital system.

<b>342005</b>	DeBaKey Dissecting Forceps 15cm 6"
<b>342010</b>	DeBaKey Dissecting Forceps 18cm 7"
<b>342020</b>	DeBaKey Dissecting Forceps 20.5cm 8.2"
<b>342030</b>	DeBaKey Dissecting Forceps Angled 15cm 6"
<b>342040</b>	DeBaKey Dissecting Forceps 24cm 9.4"

## Epilation Forceps



<b>342450</b>	Epilation Forceps Square Jaws Plain 9cm 3.5"
---------------	--

## St. Martin Dissecting Forceps



A very fine rat tooth for delicate procedures including corneal surgery.

<b>014160</b>	St. Martin Dissecting Forceps Teeth 9cm 3.5"
---------------	--

## Retractors

Good retraction is the key to success in many procedures, especially surgery on deep structures e.g. the pelvis or the larynx.

### Langenbeck Retractor



<b>684375</b>	Langenbeck Retractor 6mm Blade 21.5cm 8.5"
<b>684395</b>	Langenbeck Retractor Long Reach 6mm x 35mm Blade 21.5cm 8.5"
<b>684380</b>	Langenbeck Retractor 13mm Blade 21.5cm 8.5"
<b>684390</b>	Langenbeck Retractor 20mm Blade 21.5cm 8.5"
<b>684385</b>	Langenbeck Retractor 25mm Blade 21.5cm 8.5"

### Morris Retractor



Much wider than the Langenbeck, good for fat abdomens.

<b>684750</b>	Morris Retractor 38mm 1.5" 21.5cm 8.5"
<b>684755</b>	Morris Retractor 50mm 2" 26cm 10"
<b>684760</b>	Morris Retractor 65mm 2.5" 22cm 8.5"

### Senn (Cats Paw) Retractor



<b>833305</b>	Senn Retractor Sharp (Cats Paw) 16cm 6"
<b>833310</b>	Senn Retractor Blunt (Cats Paw) 16cm 6"

### Fat Pad Retractor



Visualisation of the medial meniscus is maximised by retraction of the fat pad. Previously this has been achieved by use of a Senn (Cats Paw) retractor. The fat pad retractor has the same clawed foot but has a much more practical means of holding the instrument.

<b>001114</b>	Fat Pad Retractor 18cm 7"
<b>001114S</b>	Fat Pad Retractor Small 18cm 7"

### Malleable (Walton) Retractors



These flat plates of soft stainless steel are bent intra-operatively to retain abdominal structures.

- 687613 Malleable Retractor 13mm 175mm
- 687825 Malleable Retractor 25mm 250mm
- 687651 Malleable Retractor 50mm 330mm

### Collins Retractor



The two blades swivel as retraction takes place. They self-centre in the incision.

- 703260 Collins Retractor 110mm Spread

### Finnochetto Rib Retractor



Finnochetto is the standard rib retractor; available in large & small.

- 704000 Rib Retractor Finnochetto Small 95mm Spread
- 704005 Rib Retractor Finnochetto Large 130mm Spread

### Gosset Retractor



Good as a rib retractor, laparotomy retractor & for retraction of ventral cervical structures during cervical fenestration.

- 701550 Gosset Retractor Large 185mm Spread
- 710600 Gosset Retractor Small 100mm Spread

### Balfour Retractor



The original Balfour has for many years served as the standard large abdominal retractor for canine surgery. However the standard midline canine approach is very different from the standard human approach. Alasdair Hotston Moore has re-visited the original design & has made some significant changes which improve the instrument both in use & sterilisation.

The central blade in the Balfour slides freely on the back bar & automatically self-centers. If the lesion or organ of interest is off-centre this is undesirable. The Balfour locking ring fits onto the back bar & may be locked in any position, holding the blade off centre. The Balfour locking ring fits all Vi Balfours.

- 25-2375AHM AHM Balfour Retractor 180mm Spread
- 25-2375 Standard Balfour Retractor 180mm Spread
- 25-2377 Medium Balfour 115mm Spread
- 25-2376 Baby Balfour Retractor 90mm Spread
- 25-2375R Balfour Locking Ring

### Ring Retractor

Some abdominal approaches require a more complex retraction system than a simple Balfour or Gossett. The Vi Ring Retractor allows the surgeon to place hooked retractor strips around the periphery of a surgical incision which may then be tensioned individually & retained around the edge of the ring.

The ring is laser cut from stainless steel which is thin enough to mould to the profile of the patient. Slots are cut every 15mm around the periphery of the ring into which lock one or more retractor strips.

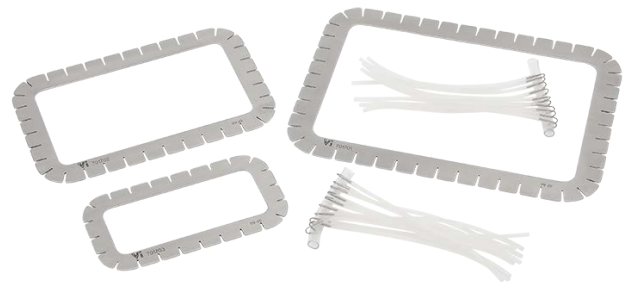

The strips are manufactured from silicone with a stainless hook. The strips are autoclavable but will require periodic replacement.

All the rings fit into standard counter-top autoclaves.

Please note: Vi Sterile Hooks are compatible with other retractor systems.

- 701700 Ring Retractor Set - S, M, L Rings With 10 Sterile Hooks
- 701701 Large Ring 200 x 130mm Internal
- 701702 Medium Ring 160 x 85mm Internal
- 701703 Small Ring 110 x 40mm Internal
- 701HOOK-A Set of 10 Sterile Hooks

## Travers Retractor



Useful for retraction of skin & superficial soft tissue.

- 703051** Travers Self Retaining Retractor 70mm Spread 16.5cm 6.5"
- 703050** Travers Self Retaining Retractor 90mm Spread 20cm 8"
- 703053** Travers Self Retaining Retractor Mini 43mm Spread 9.5cm

## Weislander Retractor



Arms are flat compared with the Wests. Proportions differ from Travers.

- 702150** Weislander Self Retaining Retractor Sharp 60mm Gape 14cm 5.5"
- 702152** Weislander Self Retaining Retractor Blunt 60mm Gape 14cm 5.5"

## West Retractor



Widely used but sharp points tend to snag tissues. Curved arms sit quite nicely on small veterinary patients.

- 703250** West Retractor 50mm Spread 14cm 5.5"
- 703253** Mini West Retractor 40mm Spread 9.5cm 4"

## Gelpi Self Retaining Retractor



The Gelpi is an extremely versatile self retaining retractor useful in almost any orthopaedic procedure. Veterinary Instrumentation Gelpis are different from standard Gelpis in two respects:

1. Short blunt tips give focal retraction for precise exposure of the fracture or lesion
2. The teeth on the ratchet are smaller than usual giving finer control over the spread of the tips

Gelpis are virtually an extra pair of hands & are invaluable where the surgeon is working without a scrubbed assistant. The curved shape fits nicely on our patients.

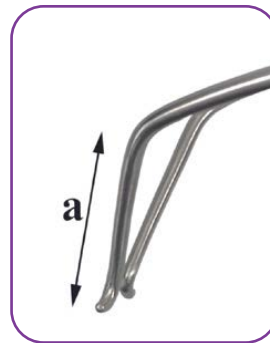

Two pairs of Gelpis placed at right angles to one another may be used to create a window into a joint or fracture site. Gelpis are available in a number of lengths. Measurement 'a' gives the depth of the tips.

Available as singles or sets of two Gelpis.

- 001330** Gelpi Retractor 120mm Spread (a=20mm) 180mm Long
- 001330SL** Gelpi Retractor With Spinlock (a=20mm) 180mm Long
- 001330S** Gelpi Retractor Sharp Tips (a=20mm) 180mm Long
- 001331** Gelpi Long Reach (a=40mm) 200mm Long
- 001331L** Gelpi Very Long Reach (a=60mm) 200mm Long
- 001332** Gelpi Small 60mm Spread (a=15mm) 135mm Long
- 0013301** Gelpi Mini Flat 45mm Spread (a=15mm) 90mm Long
- 0013302** Gelpi Mini Curved 45mm Spread (a=15mm) 90mm Long
- 0013303** Gelpi Mini Curved 45mm Spread Blunt Tips 90mm Long



- 001330/2** Gelpi Retractors 120mm Spread (a=20mm) 180mm Long Set Of 2
- 001330SL/2** Gelpi Retractors With Spinlock (a=20mm) 180mm Long Set Of 2
- 001330S/2** Gelpi Retractors Sharp Tips (a=20mm) 180mm Long Set Of 2
- 001331/2** Gelpi Long Reach (a=40mm) 200mm Long - Set Of 2
- 001331L/2** Gelpi Very Long Reach (a=60mm) 200mm Long - Set Of 2
- 001332/2** Gelpi Small 60mm Spread (a=15mm) 135mm Long - Set Of 2
- 0013301/2** Gelpi Mini Flat 45mm Spread (a=15mm) 90mm Long - Set Of 2
- 0013302/2** Gelpi Mini Curved 45mm Spread (a=15mm) 90mm Long - Set Of 2
- 0013303/2** Gelpi Mini Curved 45mm Spread 90mm Long Blunt Tips - Set Of 2
- 001333** Gelpi Self Retaining Retractors Odd Leg 205mm Pair

**Bungee Gelpi Self Retaining Retractors**



Based on the Vi standard Gelpi, with added anchor points for elastic stays allowing 4 point retraction from a single two point instrument. Anchor points may be double loaded for 6 point retraction. Accepts Vi Sterile Hooks.

Advantages:

- Better retraction with fewer retractors cluttering a wound
- Greater stability of Gelpi's within a wound with four or six point retraction preventing the tips from sliding towards each other. Easier for surgeries which are often performed in a more vertical position, such as perineal hernia repair
- More useful shape to retracted hole – more rectangular than round, square or diamond, but is very adaptable to suit the situation
- Multi-layer retraction such as creating deep retraction with tips & improved skin retraction with the elastic stays

**001330BUNGEE** Gelpi Bungee Retractor  
**701HOOK-A** Set of 10 Sterile Hooks

**Sterile Surgical Skin Marker**



Supplied in a sterile peel pouch, the surgical marker allows the surgeon to demarcate selected sites prior to or during surgery. The marker is scrub resistant, non toxic & highly visible. Especially useful around the eyes & ears where accurate reconstruction is vital. Also useful for large skin reconstruction procedures.

**001487** Surgical Skin Marker Single



**Probes & Cutting Guides**



Use the blunt probe to track fistulae. The butterfly cutting guide has a groove along its length to allow a scalpel to be run down without fear of damaging deeper tissues, the vulnerable tissues being protected by the guide. The notched spade end is useful for isolating vessels before ligating.

**901010** Blunt Dissection Probe 140mm  
**901015** Winged Director 130mm

**Cheatle Steriliser Forceps**



For manipulation of instruments during setting up.

**787655** Cheatle Steriliser Forceps 26.5cm 10.5"



**ViPP**

Through a true partnership approach, you can deliver quantifiable rewards for you and your Practice by joining our **Veterinary Instrumentation Partnership Programme.**

To find out more, scan the QR code below.





## Left Handed Instruments

Vi offer a selection of left handed instruments, identified by one black handle.

### Left Handed Instrument Starter Kit



**LHKIT** Left Handed Instrument Starter Kit

### Vi General Surgery Kit - Left Handed



**VIGSKIT-L** Vi General Surgery Kit Left Handed

Vi also offer Left Handed Spay Kits. See page 175 for further details.

### Left Handed Mayo Scissors



- 745300L** Mayo Scissor Blunt/Blunt Straight LH 14cm 5.5"
- 745400L** Mayo Scissor Blunt/Blunt Curved LH 14cm 5.5"
- 745310L** Mayo Scissor Blunt/Blunt Straight LH 16.5cm 6.5"
- 745410L** Mayo Scissor Blunt/Blunt Curved LH 16.5cm 6.5"

### Left Handed Metzenbaum Scissors



- 746100L** Metzenbaum Scissor Blunt/Blunt Straight LH 14.5cm 5.75"
- 746101L** Metzenbaum Scissor Blunt/Blunt Straight LH 15cm 6"
- 746200L** Metzenbaum Scissor Blunt/Blunt Curved LH 14.5cm 5.75"
- 746110L** Metzenbaum Scissor Blunt/Blunt Straight LH 18cm 7"
- 746115L** Metzenbaum Scissor Blunt/Blunt Straight LH 20cm 8"

### Left Handed Lister Bandage Scissors



- 744800L** Lister Bandage Scissor LH 145mm 5.5"
- 744810L** Lister Bandage Scissor LH 18cm 7"

### Left Handed Iris Scissors



- 744110L** Iris Scissor Round Straight LH 11.5cm 4.25"
- 744130L** Iris Scissor Round Curved LH 11.5cm 4.25"

### Left Handed Dressing Scissors



- 742910L** Dressing Scissors Blunt/Blunt Cvd LH 14.5cm 6"

**Left Handed Forceps**



- 103175L** Halsted Mosquito Artery Forcep Straight LH 12.5cm 5"
- 103225L** Halsted Mosquito Artery Forcep Curved LH 12.5cm 5"
- 101750L** Crile Artery Forcep Straight LH 14cm 5.5"
- 101780L** Crile Artery Forcep Curved LH 14cm 5.5"
- 106230L** Rochester Pean Artery Forcep Straight LH 16cm 6.5"
- 106275L** Rochester Pean Artery Forcep Curved LH 16cm 6.5"
- 106625L** Spencer Wells Artery Forceps Curved LH 12.5cm 5"
- 106600L** Spencer Wells Artery Forceps Straight LH 12.5cm 5"
- 106630L** Spencer Wells Artery Forceps Curved LH 15cm 6"
- 014307L** Carmalt Forceps Curved LH 20cm 8"
- 801155L** Allis Tissue Forceps 3/4 Teeth 15cm 6"
- 841350L** Backhaus Towel Forcep LH 9cm 3.5"

**Left Handed Needle Holders**



- 604715L** Mayo Hegar Needle Holder LH 16.5cm 6.5"
- 604720L** Mayo Hegar Needle Holder LH 18.5cm 7"
- 585400L** Olsen Hegar Needle Holder LH 14cm 5.5"
- 605355L** Olsen Hegar Needle Holder LH 16.5cm 6.5"
- 585420L** Olsen Hegar Needle Holder LH 18cm 7"

**Left Handed Foster Gillies**



- 582660** Foster Gillies Needle Holder LH 12.5cm 5"
- 602705** Foster Gillies Needle Holder LH TC Jaws 12.5cm 5"

**Left Handed Gillies**



- 582951** Gillies Needle Holder LH 16cm 6.25"
- 602951** Gillies Needle Holder LH TC Jaws 16cm 6.25"

# Soft Tissue



To visit the Soft Tissue section of our website, please scan the QR code.



# The BOAS

## Mouth Gag Range



## BOAS Mouth Gag



The BOAS Mouth Gag from Vi has been developed specifically to aid surgeons performing BOAS surgery. The unique design allows vastly improved visualisation and surgical access during these procedures.

This device is based on the design of the ever-popular table-top gag for rabbit and rodent dentistry, with several key features and adaptation specifically intended for BOAS surgery.. UK Patent granted.

Special design features include:

- Fully adjustable tilting base to support the upper body of the patient at the desired angle to maximise visualisation and access.
- The tilting base is supported by sturdy upright bars to ensure excellent stability and optimal weight capacity.
- Two adjustable horizontal bars to retain the patients' mouth open in the desired position. Both bars are adjustable up/down, and the upper bar also adjusts forwards/backwards.
- Silicone bar sleeves for the horizontal bars are available to minimise potential trauma to the patient's gums.
- Front-positioned cleat hook to allow tie-down of the tongue if desired.
- Supporting hook for the ET tube or anaesthetic circuit. This is height-adjustable and can be positioned to either the front or the side of the upright.

<b>BOASMG</b>	BOAS Surgery Mouth Gag Complete
<b>BOASST</b>	BOAS Silicone Bar Sleeve 190mm Long
<b>BOASST-SML</b>	BOAS Silicone Bar Sleeve - Small Bars
<b>BOASBARS-SML</b>	Small Bar Set for BOAS Mouth Gag c/w Silicone Sleeves

## BOAS Surgical Kit



Vi supply a set of instruments suitable for BOAS and upper airway surgery. The BOAS Standard Surgical Kit contains:

014050	Soft Palate Clamps Internal 18x7mm	x1
014040	Soft Palate Clamps Internal 26x12mm	x1
760012	Metzenbaum Supercut Scissors 180mm Cvd	x1
801156	Allis Tissue Forceps 3/4 Teeth 180mm	x2
602010	DeBakey TC Needleholder 200mm	x1
342020	DeBakey Atraumatic Dissecting Forceps 205mm	x1
BX201470P-F	Premium Instrument Box 300x140x70mm w/ Filters x1	
PBXS270125	Fingered Silicone Mat 270x125mm Green	x1

**BOASSTDKIT** BOAS Surgical Kit - Standard

## BOAS Premium Kit

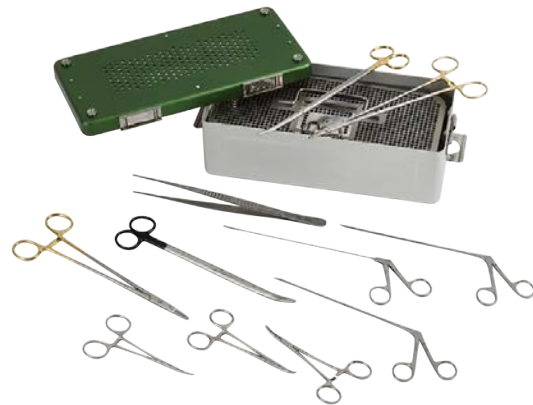

Vi supply a set of premium instruments suitable for BOAS and upper airway surgery. The BOAS Premium Surgical Kit contains:

103160	Mosquito Forceps XX Micro Curved	x1
014057	Fine Tubular Grasping Forceps 7in	x1
606355	Ryder TC Needle Holder Mini Profile Tip 4-230mm	x1
760020	Ligature Scissors Supercut 230mm	x1
754050	Metzenbaum Fino TC Blunt/Blunt 9"	x1
342040	DeBakey Atraumatic Dissecting Forceps 240mm	x1
014080	Micro Scissors Left Curve S/S Vertical Cut 175mm	x1
014081	Micro Scissors Right Curve S/S Vertical Cut 175mm	x1
602030	DeBakey Needleholder TC 225mm	x1
103225	Halstead Mosquito Artery Forceps 125mm CVD	x2
BX301410P-F	Premium Instrument Box 300x140x100mm W/ Filters x1	
PBBXINNERI	Perforated Tray with Lid 270x123x65mm	x1
PBBXRD2	Instrument Holding Pin for Wire Baskets	x4
PBBXRD1	Silicone Instrument Holders Open Top	x1

**BOASPREMKIT** BOAS Surgical Kit -Premium

## Micro Scissors

<b>14080</b>	Micro Scissors Left Curve Vertical Cut S/S 175mm
<b>14081</b>	Micro Scissors Right Curve Vertical Cut S/S 175mm

## Disposable Tracheostomy Tubes

<b>014076</b>	Tracheostomy Tube I/D 2.5mm O/D 4.0mm
<b>014077</b>	Tracheostomy Tube I/D 4.0mm O/D 6.0mm
<b>014078</b>	Tracheostomy Tube I/D 5.5mm O/D 8.0mm
<b>014079</b>	Tracheostomy Tube I/D 7.0mm O/D 10.0mm



### Airway Surgery Soft Palate Clamp



An overlong palate is a common cause of dyspnoea in the brachiocephalic dog. Shortening the soft palate in an atraumatic manner provides almost immediate relief.

The soft palate clamp was designed by Geoff Lane FRCVS.

The jaws have a special atraumatic grip to hold the very slippery soft palate.

- 014040 Soft Palate Clamps Large 26 x 12mm 170mm Long
- 014050 Soft Palate Clamps Small 18 x 7mm 170mm Long

### Tonsillectomy Clamp



The standard Negus clamp may be used in pairs for soft palate resection. A right angled version designed by Stephen Baines at the Willows is also available.

- 014038 Tonsillectomy Clamp Right Angle 190mm Long
- 014039 Tonsillectomy Clamp Curved 190mm Long

### Negus Forceps



- 7018/05 Negus Artery Forceps Small Cof 18cm 7"

### Satinsky Clamp



Useful for intra-thoracic surgery, trimming soft palates & even ears. Atraumatic design maximises haemostasis & minimises trauma.

- 2685/03 Satinsky Clamps 20mm Jaw 160mm Long
- 2685/05 Satinsky Clamps 30mm Jaw 200mm Long

### Soft Tissue Biopsy Forceps



Designed to take samples of soft tissue masses from the ear or via the mouth, these forceps come in three sizes & will work in combination with standard aural speculae.

Fits down all usual aural speculae.

- 014087 Cup Biopsy Forceps 2mm Diameter Shaft 75 x 3.6mm
- 014087A Cup Biopsy Forceps 2mm Diameter Shaft 100 x 3.6mm
- 014088 Cup Biopsy Forceps 3.5 x 8mm Shaft 105 x 5.6mm

### Angled Allis Tissue Forceps



This angled Allis has 4 into 5 teeth at the tip & is angled mid shaft. The kink in the shaft of the Allis allows use in the upper airway & pharynx without obstructing other instrumentation. Please note, at 20cm the length is longer than the standard Allis.

- 801161 Angled Allis Tissue Forceps 4/5 Teeth 20cm Long

## Aural Surgery

### Malleable Instrument Set



Fully flexible instruments are difficult to control. Malleable instruments allow the tips to be positioned exactly where the surgeon needs them. The malleable instrument set contains:

014098	Malleable Grasping Forceps 145mm Shaft	x1
014099	Malleable Biopsy Forceps 2mm Cup 145mm Shaft	x1
012528	Malleable Ear Loop Curette 2.0mm Diameter	x1
012529	Malleable Ear Loop Curette 4.0mm Diameter	x1

Stainless steel box with silicone insert.

**014125** Malleable Instrument Set in Stainless Steel Case

### Canine Ear Loop



Removal of hard wax & other debris from the canine horizontal canal without causing trauma is a common problem in veterinary surgery.

It is now accepted that the use of ear loops is more effective than cotton tipped products. Most human ear loops are too large & too short for use with the much longer veterinary speculae.

Vi's Canine Ear Loop is slimmer & longer to facilitate debris removal without obscuring the visual field. The flexible ear loop is very fine & flexible for added safety. The Buck ear loop is firmer.

<b>012526</b>	Canine Buck Looped Ear Curette
<b>012528</b>	Flexible Ear Loop Cat/Small Dog Size 160mm Long
<b>012529</b>	Flexible Ear Loop Medium/Large Dog Size 160mm Long

### Malleable Grasping & Biopsy Forceps



The fine flexible grasping forceps have a maximum diameter of 1.7mm & are therefore ideal for small working channels & speculae. The forceps are available as graspers or as biopsy forceps.

<b>014098</b>	2mm Malleable Grasping Forceps 145mm
<b>014099</b>	2mm Malleable Biopsy Forceps 145mm

### Crocodile Forceps



Removal of foreign bodies, particularly grass seeds, is achieved using long crocodile forceps. Available in traditional designs or as a fine tubular shaft design.

<b>014091</b>	Extra Fine Crocodile Forceps Tubular 3" Shaft
<b>014092</b>	Extra Fine Crocodile Forceps Tubular 5" Shaft
<b>014093</b>	Extra Fine Crocodile Forceps Tubular 7" Shaft
<b>014089</b>	Extra Fine Crocodile Forceps Tubular 9" Shaft
<b>014094</b>	Aural Crocodile Forceps Standard Jaw 3" Shaft
<b>014095</b>	Aural Crocodile Forceps Standard Jaw 5" Shaft
<b>014096</b>	Aural Crocodile Forceps Standard Jaw 7" Shaft

### TECA Retractor - Pieter Nelissen



Achieving adequate exposure is essential when performing lateral bulla osteotomy & debridement, especially in broad headed breeds, this will mean working down a narrow & surprisingly deep corridor.

Following the suggestion from Pieter Nelissen, we have developed a purpose made TECA Retractor. The 40mm long legs are at 80° to the handles to reach deep into the hole created. The cross-over tips are only 3mm across when closed enabling insertion with no edges protruding to snag tissues.

<b>001338</b>	TECA Retractor 105mm Long 40mm Cross-Over Legs
---------------	--

### Bulla Rongeurs



<b>142280</b>	Bulla Rongeurs 200mm
---------------	----------------------

### Implants For Hart Pinna Haematoma System

<b>014601U/S</b>	Fenestrated Implants Pack of 12 Supplied Sterilised
------------------	---

## Thoracic Surgery

### Thoracic Surgery Kit



Working inside the chest of medium & large dogs will require extended instrumentation. The instruments listed below represent a useful kit. In addition a pair of rib retractors will be required. Other useful instruments include extra long Metzenbaum scissors & right angled forceps (Lahey cholecystectomy clamp & small right angled forceps).

The Thoracic Surgery Kit contains:

106205	45 Degree Curved Forceps 220mm	x1
105415	90 Degree Curved Forceps 245mm	x1
754060	Metz Scissors Str 235mm T.C.	x1
754120	Metz Scissors Curved 235mm T.C.	x1
342020	DeBakey Thumb Forceps 205mm	x1
347665	Rat Tooth Thumb Forceps 205mm	x1
602010	DeBakey Needleholders T.C. 200mm	x1
347655	Dressing Forceps 205mm	x1
2685/03	Satinsky Clamps 160mm Long 20mm Jaw	x1
2685/05	Satinsky Clamps 200mm Long 30mm Jaw	x1
BX281450	Instrument Box 280x140x50mm	x1

**CAMTHORKIT** Thoracic Surgery Kit

### Finochietto Rib Retractors



<b>704000</b>	Rib Retractor Finochietto 95mm
<b>704005</b>	Rib Retractor Finochietto 130mm

### Right Angled Clamps



Typically used to dissect around a patent ductus arteriosus & then pull through appropriate ligative material.

<b>014051</b>	Right Angled Lahey Cholecystectomy Clamps 195mm Long
<b>014052</b>	Small Right Angle Clamps 160mm Long
<b>014052S</b>	Small Right Angle Clamps Without Ratchet 160mm Long
<b>014052M</b>	Mixer Forceps With Ratchet 140mm Long
<b>014052A</b>	Right Angled Clamp With Ratchet 250mm

### Curved Forceps - Long



<b>106205</b>	45 Degree Curved Forceps 220mm Long
<b>105415</b>	90 Degree Curved Forceps 235mm Long



## Thoracic Surgery

### Foreign Body Retrieval Forceps

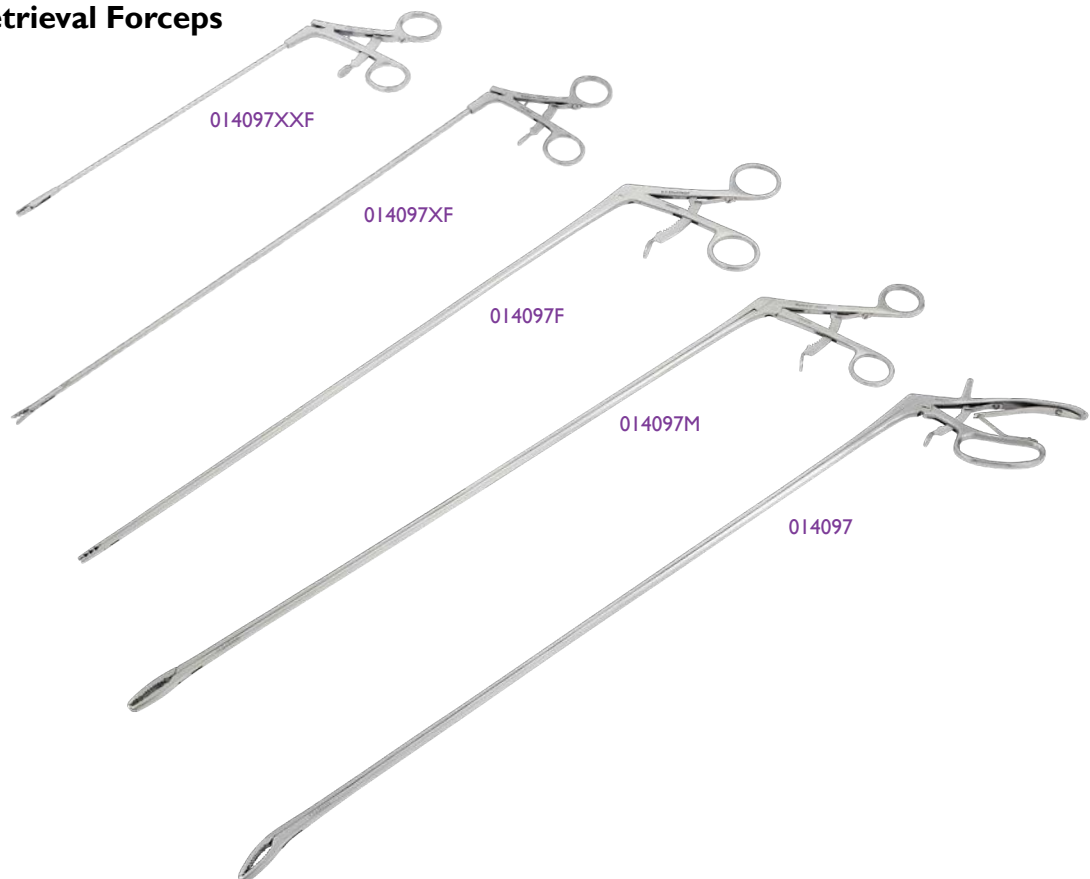

We offer a range of forceps to cover every eventuality from a bone in the oesophagus of a large dog to a grass seed in a cat trachea.





The forceps may be guided by rigid or flexible endoscopes or fluoroscopy. In exceptional cases retrieval may be achieved by 'feel'.

The teeth on these forceps face backwards for maximum grip. When closed the jaws are atraumatic for minimal damage to the oesophagus or trachea. It is helpful to inflate the oesophagus prior to withdrawal of spiky objects.

#### Key Features:

- Backward-facing teeth for maximum grip
- Jaws are externally atraumatic
- Shaft diameter as small as possible
- Large forceps jaws are angled when closed so that when open they sit mid-oesophagus

<b>014097</b>	Foreign Body Retrieval Forceps	640mm Shaft Length
<b>014097M</b>	Foreign Body Retrieval Forceps	500mm Shaft Length
<b>014097F</b>	Foreign Body Retrieval Forceps	400mm Shaft Length
<b>014097XF</b>	Foreign Body Retrieval Forceps	400mm Shaft Length
<b>014097XXF</b>	Foreign Body Retrieval Forceps	220mm Shaft Length

Code		Diameter at Jaws in mm	Length at Jaws in mm	Shaft Diameter in mm	Shaft Length in mm
014097		16 x 8	37	8.5 x 7	640
014097M		11.5 x 6	31	6 x 8	500
014097F		6 x 4.2	14.5	6 x 4.2	400
014097XF		4.5	1.5	4.5	400
014097XXF		4	9	3	220

## Ovariohysterectomy

### Feline Spay Kit



The Feline Spay Kit contains:

585400	Olsen Hegar Needleholders 140mm Long	x1
746100	Metzenbaum Scissors Straight 145mm Long	x1
106625	Spencer Wells Artery Forceps Curved 125mm Long	x2
103225	Halstead Mosquito Forceps Curved 125mm Long	x2
014211	Spay Forceps 125mm Long	x1
341210	Adson Dissecting Forceps 1/2 Teeth 125mm Long	x1
171566	Jones Cross Action Towel Clips 90mm Long	x2
0803	Scalpel Handle No.3	x1
BX201040	Stainless Steel Instrument Box	x1

**SPAYFEL** Cased Feline Spay Kit

### Alternative Feline Spay Kit

The Alternative Feline Spay Kit contains:

585400	Olsen Hegar Needleholders 140mm Long	x1
746101	Metzenbaum Scissors Straight 150mm Long	x1
106625	Spencer Wells Artery Forceps Curved 125mm Long	x3
103225	Halstead Mosquito Forceps Curved 125mm Long	x3
014211	Spay Forceps 125mm Long	x1
341210	Adson Dissecting Forceps 1/2 Teeth 125mm Long	x1
171566	Jones Cross Action Towel Clips 90mm Long	x2
0803	Scalpel Handle No.3	x1
801150	Allis Tissue Forceps 2/3 Teeth 150mm	x1

**SPAYFEL-V2** Cased Feline Spay Kit V2

### Canine Spay Kit



The Canine Spay Kit contains:

585410	Olsen Hegar Needleholders 165mm Long	x1
745300	Mayo Chamf Blades Straight 140mm Long	x1
106630	Spencer Wells Artery Forceps Curved 150mm Long	x4
014307	Carmault Forceps Curved 200mm Long	x2
801155	Allis Tissue Forceps 3/4 Teeth 150mm Long	x2
341145	Dissecting Forceps 1/2 Teeth 150mm Long	x1
171566	Jones Cross Action Towel Clips 90mm Long	x4
0803	Scalpel Handle No.3	x1
BX221550	Stainless Steel Instrument Box	x1
BXSL2215	Silicone Insert	x1

**SPAYCAN** Cased Canine Spay Kit

### Alternative Canine Spay Kit

The Alternative Canine Spay Kit contains:

585410	Olsen Hegar Needleholders 165mm Long	x1
745300	Mayo Chamf Blades Straight 140mm Long	x1
106630	Spencer Wells Artery Forceps Curved 150mm Long	x4
014307	Carmault Forceps Curved 200mm Long	x2
801155	Allis Tissue Forceps 3/4 Teeth 150mm Long	x2
341145	Dissecting Forceps 1/2 Teeth 150mm Long	x1
171566	Jones Cross Action Towel Clips 90mm Long	x4
0803	Scalpel Handle No.3	x1
106605	Spencer Wells Artery Forceps 150mm Str	x4

**SPAYCAN-V2** Cased Canine Spay Kit V2

## Left Handed Spay Kits

The full contents for Vi's Left Handed Spay Kits can be found on page 176.

**SPAYFEL-L** Cased Feline Spay Kit Left Handed

**SPAYCAN-L** Cased Canine Spay Kit Left Handed

## Spay Hooks



Use to atraumatically lift uterine horns.

**014320** Spay Hook Small 130mm Long

**014325** Spay Hook Large 170mm Long

## Spay Forceps



Atraumatic spay forceps-tips have fine toothed DeBakey type form.

**014211** Spay Forceps 125mm Long

**014218** Spay Forceps (DeBakey Type) 125mm Long

## Angiotribes



The jaws of this instrument are designed for maximum crushing by serrated longitudinal grooves.

**014304** Angiotribes Straight 160mm

**014305** Angiotribes Curved 160mm

**014301** Angiotribes Straight 200mm

**014302** Angiotribes Curved 200mm

## Hysterectomy Clamps (Carmault)

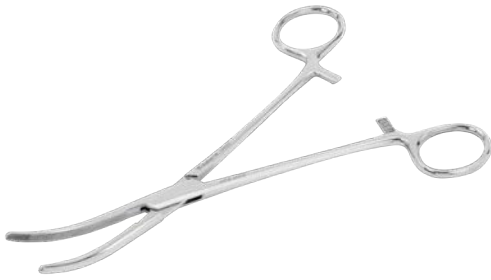

These clamps are curved with longitudinal grooves in the jaws to minimise tissue slippage.

- 014307 Hysterectomy Clamp (Carmault) 200mm Long
- 014309 Hysterectomy Clamp (Carmault) 160mm Long
- 014307L Carmault Forceps Curved LH 200mm

## Howard 'B' Ovariohysterectomy Clamp



Designed & developed in practice by Howard Taylor who recognised that ovariohysterectomy was far from straightforward, particularly but not exclusively for recent graduates.

The clamp has a number of features which assist the surgeon in the exposure & ligation of the ovarian pedicle.

- The ligature material is preloaded onto the forceps which takes it through the broad ligament
- Longitudinal grooves in the jaw minimise slippage
- As the forceps are rotated the 'B' shaped extension 'collects' & brings together the structures of the pedicle ready for tying
- The forceps sit outside the incision to exteriorise the pedicle
- The ligature is tied without precrushing but is retained by a small haemostat to check for bleeding prior to closure

- 546470 Howard 'B' Ovariohysterectomy Clamp 160mm Long

## Hauptman Retractors



This retractor designed by Joe Hauptman maintains distal retraction of the ovary during ligation of the ovarian pedicle. This is the crucial part of the procedure which can be a challenge for even experienced surgeons.

- 014400 Small Hauptman Retractor 10mm Blade
- 014410 Medium Hauptman Retractor 15mm Blade
- 014420 Large Hauptman Retractor 20mm Blade

## Obstetrical Items



- 546465 Hobdays Obstetric Forceps for Cats 150mm Long
- 546466 Hobdays Obstetric Forceps for Dogs 210mm Long



- 546455 Killian Bitch Speculum Blade Length 650mm Long (2½")

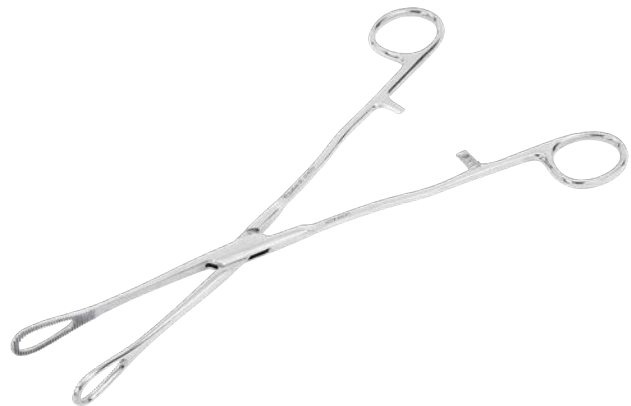

- 014310 Miss Freakes Whelping Forceps 260mm Long

## Abdominal Surgery

### Vascular Probe Set



A set of 15 vascular probes in a fully autoclavable stainless steel case. The 25mm long angled working tips are of specified diameter permitting accurate documentation of blood vessel diameter & marriage of blood vessel diameters when performing vascular anastomoses. With an overall length of 225mm, these are especially useful in abdominal surgery, in particular for documenting hepatic shunts.

The set includes probe diameters of 1.25mm, 1.5mm, 1.75mm, 2mm, 2.25mm, 2.5mm, 2.75mm, 3mm, 3.25mm, 3.5mm, 3.75mm, 4mm, 4.5mm, 5mm & 6mm. Diameters are clearly etched on the handles.

**0014SET** Vascular Probe Set

### Balfour Retractors



The original Balfour has for many years served as the standard large abdominal retractor for canine surgery. However the standard midline canine approach is very different from the standard human approach. Alasdair Hotston Moore has re-visited the original design & has made some significant changes which improve the instrument both in use & sterilisation.

- 25-2375AHM** AHM Balfour Retractor 180mm Spread
- 25-2375** Standard Balfour Retractor 180mm Spread
- 25-2377** Medium Balfour 115mm Spread
- 25-2376** Baby Balfour Retractor 90mm Spread
- 25-2375R** Balfour Locking Ring

### Ring Retractor

Some abdominal approaches require a more complex retraction system than a simple Balfour or Gossett. The Vi Ring Retractor allows the surgeon to place hooked retractor strips around the periphery of a surgical incision which may then be tensioned individually & retained around the edge of the ring.

The ring is laser cut from stainless steel which is thin enough to mould to the profile of the patient. Slots are cut every 15mm around the periphery of the ring into which lock one or more retractor strips.

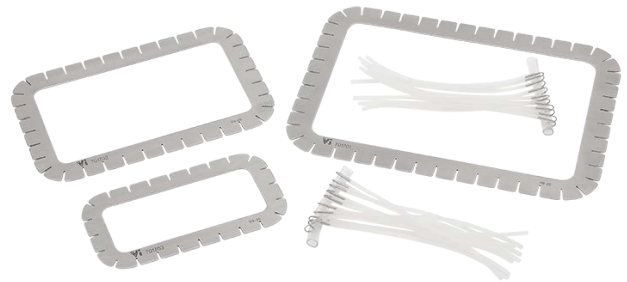

The strips are manufactured from silicone with a stainless hook. The strips are autoclavable but will require periodic replacement.

All the rings fit into standard counter-top autoclaves.

Please note: Vi Sterile Hooks are compatible with other retractor systems.

- 701700** Ring Retractor Set - S, M, L Rings With 10 Sterile Hooks
- 701701** Large Ring 200 x 130mm Internal
- 701702** Medium Ring 160 x 85mm Internal
- 701703** Small Ring 110 x 40mm Internal
- 701HOOK-A** Set of 10 Sterile Hooks

### Ameroid Constrictors



Supplied sterile. Used exclusively in the surgical treatment of hepatic shunts, the Ameroid Constrictor gradually occludes the blood vessel in question allowing the circulation to adjust.

The Casein (clay-like) layer expands as it absorbs water, constricting the blood vessel within. Insertion of metal locking key prevents constrictor from slipping from blood vessel.

Colour variation of the Casein material is normal & does not indicate a defect. The outer case is 304 Stainless Steel.

#### Selection of Ameroid Constrictor.

Once the portosystemic shunt has been identified & exposed it is suggested that a constrictor should be selected which initially encloses the vessel but does not constrict it.

- AC35-A** Ameroid Constrictor 3.5mm Sterile
- AC40-A** Ameroid Constrictor 4.0mm Sterile
- AC45-A** Ameroid Constrictor 4.5mm Sterile
- AC50-A** Ameroid Constrictor 5.0mm Sterile
- AC60-A** Ameroid Constrictor 6.0mm Sterile
- AC70-A** Ameroid Constrictor 7.0mm Sterile

## Doyen Bowel Clamp

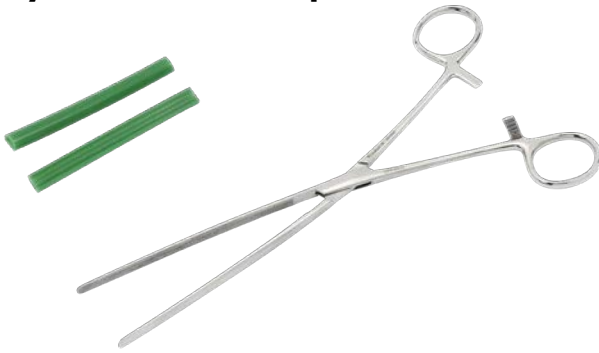

**201950** Bowel Clamps Doyen Str 9.5" 24cm  
**201955** Bowel Clamps Doyen Cof 9.5" 24cm

Autoclavable soft silicone shoes created to fit the Doyen Bowel Clamps, making the Doyen more atraumatic. Ribs maximise grip.

**EXTR201950** Silicone Shoe For Doyen Bowel Clamps 1 Pair  
**EXTR201950/3** Silicone Shoe For Doyen Bowel Clamps 3 Pairs  
**EXTR201950/10** Silicone Shoe For Doyen Bowel Clamps 10 Pairs  
**EXTR201950/20** Silicone Shoe For Doyen Bowel Clamps 20 Pairs

## Atraumatic Small Bowel Clamp



Jaw design gently holds & seals the bowel with a minimum of pressure & trauma. The fine ratchet facilitates gentle yet secure application.

**222165** Bowel Clamps Atraumatic Str 17cm 7" Long  
**222170** Bowel Clamps Atraumatic Cof 17cm 7" Long

## Resano Bowel Clamp

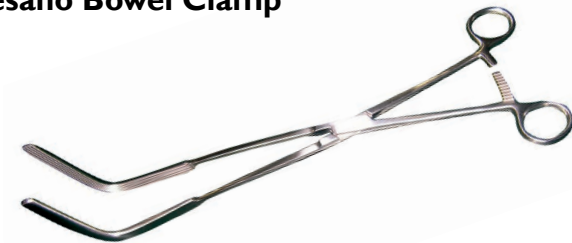

**201956** Resano Bowel Clamp 20.5cm 8" Long

## Soft Edge Surgical Spoon



Removing calculi from the bladder or impacted faeces from the rectum requires great care to avoid damage.

Our soft edge spoons have been designed & manufactured with veterinary procedures in mind.

Available in three sizes:

- XSmall 230 x 15 x 8mm
- Small 250 x 20 x 10mm
- Large 270 x 44 x 23mm

**014703** Soft Edged Spoon - XSmall  
**014700** Soft Edged Spoon - Small  
**014701** Soft Edged Spoon - Large  
**014702** Soft Edged Spoon - Set of 3



## Loan Kits

For a nominal fee, we have a range of **specialist loan kits** available to complement your own fleet. With next working day availability, the service offers flexibility as procedures are booked with your clients.

To find out more, scan the QR code below.



## Norfolk Vet Products

The Norfolk & DocXS products are based around the CompanionPort device. This is a titanium port with a silicone septum which is implanted during a surgical procedure beneath the skin at a suitable site, depending on accessory connection required. The port is then accessed percutaneously using a special non-coring Huber point needle to either withdraw, sample or administer/flush as required, with minimal disturbance & distress to the patient.

Surgical guides and further information is available online at [www.norfolkvetproducts.com](http://www.norfolkvetproducts.com)

### Pleural Port

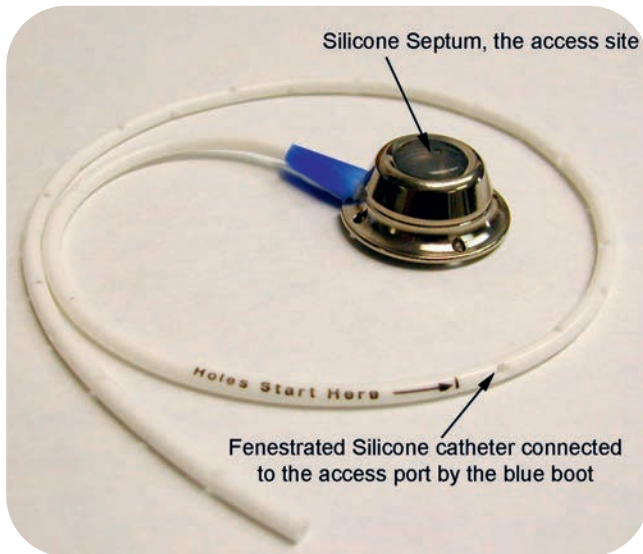

This version of the Port kit consists of a silicone fenestrated catheter for insertion into the thoracic cavity, with a CompanionPort & three sizes of Huber needle.

Indications for use are repeated aspiration of the thoracic cavity, or intra-cavity chemotherapy.

- NOR-PP-102K** Pleural Port - Dogs
- NOR-PP-202K** Pleural Port - Cats
- NOR-NPX-10** Introducer Kit for Canine Pleural Port



## CompanionPort for Vascular Access

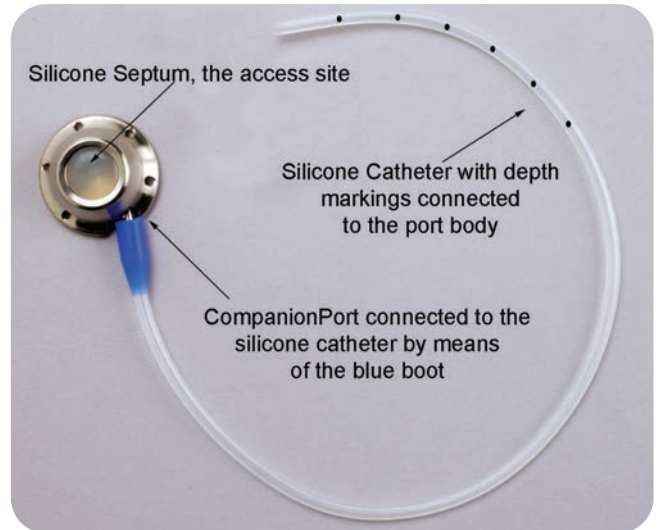

The CompanionPort for vascular access is designed to provide a more comfortable way of gaining repeated access to the venous system for both delivery of medication and repeat blood sampling.

Each kit contains a titanium port (3 sizes available) and a round tip radiopaque silicone catheter with depth markings. 22g Huber needles are included in all sizes.

- NOR-CP-100K** CompanionPort Vascular Access Le Petite - Small Cats
- NOR-CP202K** CompanionPort Vascular Access Le Port - Cats & Small Dogs
- NOR-CP305K** CompanionPort Vascular Access Le Grande - Larger Dogs



## Training & Education

Our **e-learning platform** delivers a variety of technical and clinical educational material, in an engaging and interactive format.

With a CPD certificate awarded upon successful completion of each module, the e-learning platform from Vi will help you to fulfil your annual CPD requirements.

Sign up today by scanning the QR code below.



## The SUB™ - A Subcutaneous Ureteral Bypass System

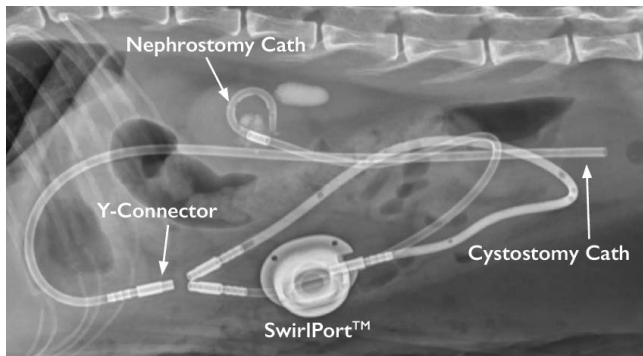

The Subcutaneous Ureteral Bypass (SUB™) device is a unique system designed for use in cats and dogs.

Redesigned to reduce some of the most common complications seen in prior SUB™ devices, the SUB™ 3.0 consists of one or two locking loop pigtail catheters placed in the kidney(s), one straight catheter placed in the bladder, a subcutaneous titanium SwirlPort™, and a “Y” or “X” Connector junction for securing the catheters.

Indications for using the SUB™ 3.0 include:

- Ureteral Obstruction associated with Ureteral Stone Disease
- Ureteral Strictures – the abnormal narrowing of the ureter
- Ureteral Stent Reaction
- Ureteral Stent Intolerance
- Malignant Obstructions

Items included in the kit:

SwirlPort Access Port and Catheter Tubing, Locking Loop Nephrostomy Catheter(s), Straight Bladder Catheter, “Y” or “X” Connector, .035” J-Tip Guidewire, 2 x Posi-grip Huber Point Needles, Over-the-Needle IV Catheter(s), Blue Boot Catheter Connectors.

<b>NOR-SUB3-2001K</b>	Sub Device 3.0 Kit Cats & Small Dogs
<b>NOR-SUB3-2002K</b>	Sub Device 3.0 Kit Long for Larger Dogs
<b>NOR-SUB3-3001K</b>	Sub Device 3.0 Kit Bilateral for Cats & Small Dogs

Not included in the kit - optional extras include:

<b>I050052</b>	Histoacryl Tissue Glue (Pack of 5)
<b>NOR-SFK-20</b>	20g Sub Flush Kit (Case of 5)
<b>NOR-SFK-22</b>	22g Sub Flush Kit (Case of 5)
<b>NOR-TFL-1202</b>	T-FLOLOC™ 2ml 2% Tetra EDTA Solution in 12ml Syringe Box of 10

Kit components available separately:

<b>NOR-BC-7</b>	Bladder Catheter 7FR
<b>NOR-LL6.5</b>	Kidney (Pigtail) Catheter 6.5FR
<b>NOR-SHU-PP</b>	3 Way Sub Port Only
<b>NOR-GW-035</b>	J Tipped .035” Guide Wire
<b>DC-7</b>	Metal Male To Male Adaptor For Sub Device
<b>NOR-SP4</b>	Medium Swirlport For Sub 3.0 Port Only
<b>NOR-X-CONNECTOR</b>	4 Way X Connector For Bilateral Sub 3.0
<b>NOR-Y-CONNECTOR</b>	3 Way Y Connector For Unilateral Sub 3.0

## Artificial Urethral Sphincter (AUS) Port System

The Artificial Urethral Sphincter Port System (AUS™) is designed for dogs and cats for the long-term relief of sphincter mechanism incontinence that is unresponsive to medical management.

The AUS Port system has 2 components: a titanium access port and a silicone AUS occluder catheter.

The device employs a silicone cuff placed around the proximal urethra and filled with variable amounts of saline to provide mechanical obstruction to urine flow through the urethra. The degree of resistance to flow is adjusted using a subcutaneous access/injection port that is subcutaneously placed on the inner thigh. There is no exit site.



The AUS Port System – the access port, occluder and accessories – are packaged as a sterile kit complete with Huber point accessing needles.

<b>DXAUS-KIT-6X11</b>	AUS Port System Kit 6 x 11mm Cuff
<b>DXAUS-KIT-10X11</b>	AUS Port System Kit 10 x 11mm Cuff
<b>DXAUS-KIT-6X14</b>	AUS Port System Kit 6 x 14mm Cuff
<b>DXAUS-KIT-8X14</b>	AUS Port System Kit 8 x 14mm Cuff
<b>DXAUS-KIT-10X14</b>	AUS Port System Kit 10 x 14mm Cuff
<b>DXAUS-KIT-12X14</b>	AUS Port System Kit 12 x 14mm Cuff
<b>DXAUS-KIT-14X14</b>	AUS Port System Kit 14 x 14mm Cuff
<b>DXVO-CATH45</b>	AUS & HSO Backfill/Flush Catheter

### AUS Port System Components

Access Port available in 3 sizes supplied sterile with Huber needles:

<b>DXAUS-KIT-CP6</b>	Companion Port Kit S Sterile
<b>DXAUS-KIT-CP4</b>	Companion Port Kit M Sterile
<b>DXAUS-KIT-CP2</b>	Companion Port Kit L Sterile

Most common size can be purchased as port only supplied sterile:

<b>DXAUS-CP4</b>	Companion Port Only M
------------------	-----------------------

Cuffs available individually; supplied sterile:

<b>DXAUS-4X11</b>	Artificial Urethral Sphincter 4x11mm Sterile
<b>DXAUS-6X11</b>	Artificial Urethral Sphincter 6x11mm Sterile
<b>DXAUS-6X14</b>	Artificial Urethral Sphincter 6x14mm Sterile
<b>DXAUS-8X11</b>	Artificial Urethral Sphincter 8x11mm Sterile
<b>DXAUS-8X14</b>	Artificial Urethral Sphincter 8x14mm Sterile
<b>DXAUS-10X11</b>	Artificial Urethral Sphincter 10x11mm Sterile
<b>DXAUS-10X14</b>	Artificial Urethral Sphincter 10x14mm Sterile
<b>DXAUS-12X11</b>	Artificial Urethral Sphincter 12x11mm Sterile
<b>DXAUS-12X14</b>	Artificial Urethral Sphincter 12x14mm Sterile
<b>DXAUS-14X11</b>	Artificial Urethral Sphincter 14x11mm Sterile
<b>DXAUS-14X14</b>	Artificial Urethral Sphincter 14x14mm Sterile
<b>DXAUS-16X11</b>	Artificial Urethral Sphincter 16x11mm Sterile
<b>DXAUS-16X14</b>	Artificial Urethral Sphincter 16x14mm Sterile

## Hepatic Shunt Occluder (HSO) System



The Hepatic Shunt Occluder (HSO™) Port System is designed to produce gradual and complete occlusion of Congenital Portosystemic Shunts (IHPS) that is percutaneously controlled through an access port. The occlusion is easily reversed if postoperative portal hypertension occurs.

The HSO-Port System consists of an inflatable silicone cuff and a titanium access port.

The full kit contains:

- 1 x access port (Medium supplied as standard)
- 1 x HSO (size as selected)
- 2 x 22g Huber point needles
- 1 x 22g right angle infusion set

- DXHS-KIT-HS-4** Hepatic Shunt Kit 4mm
- DXHS-KIT-HS-6** Hepatic Shunt Kit 6mm
- DXHS-KIT-HS-8** Hepatic Shunt Kit 8mm
- DXHS-KIT-HS-10** Hepatic Shunt Kit 10mm
- DXHS-KIT-HS-12** Hepatic Shunt Kit 12mm
- DXHS-KIT-HS-14** Hepatic Shunt Kit 14mm
- DXHS-KIT-HS-16** Hepatic Shunt Kit 16mm
- DXVO-CATH45** AUS & HSO Backfill/Flush Catheter

Access Port available in 2 sizes supplied sterile with Huber needles:

- DXAUS-KIT-CP4** Companion Port Kit M Sterile
- DXAUS-KIT-CP2** Companion Port Kit L Sterile

Most common size can be purchased as port only supplied sterile:

- DXAUS-CP4** Companion Port Only M

HSO available singly, supplied sterile:

- DXHS-4** Hepatic Shunt Occluder 4mm Sterile
- DXHS-6** Hepatic Shunt Occluder 6mm Sterile
- DXHS-8** Hepatic Shunt Occluder 8mm Sterile
- DXHS-10** Hepatic Shunt Occluder 10mm Sterile
- DXHS-12** Hepatic Shunt Occluder 12mm Sterile
- DXHS-14** Hepatic Shunt Occluder 14mm Sterile
- DXHS-16** Hepatic Shunt Occluder 16mm Sterile

## Huber Needles



These special non-coring needles are required to access the silicone septum of the CompanionPort without the damage associated with traditional needles. They are also known as deflected-point needles.

When withdrawn after use, the septum re-seals itself.

- NOR-NV-PG22-75** 22g Huber Needle 3/4" Black Box of 12
- NOR-NV-PG22-100** 22g Huber Needle 1" Black Box of 12
- NOR-NV-PG20-75** 20g Huber Needle 3/4" Yellow Box of 12
- NOR-NV-PG20-100** 20g Huber Needle 1" Yellow Box of 12
- NOR-NV-PG19-75** 19g Huber Needle 3/4" Brown Box of 12
- NOR-NV-RA19-100** 19g Huber Needle 1" Box of 12
- NOR-NV-RA22-75-6** 22g Right Angle Huber 3/4" with 6" Extension Box of 12
- DXHUBERRIGHT** 22g Right Angle Huber Infusion Set 3/4" Single Sterile

## SUB Flush Kit

This convenient kit contains the items you need to quickly and effectively flush the SUB™ System.

SUB™ Flush Kit Contents

SFK-22 – for use with All Shunting Ports

- 1x T-Port Connector
- 1x 3-Way Stop-Cock
- 1x 22-Gauge Huber Point Needle
- 2x 3ml Syringe
- 1x 2.5ml Sterile Saline in 3ml Syringe
- 1x 2ml T-FloLoc in 12ml Syringe

- NOR-SFK-22** 22g Sub Flush Kit (Case of 5)

SFK-20 – option for Swirl and Large Shunting Ports

- 1x T-Port Connector
- 1x 3-Way Stop-Cock
- 1x 20-Gauge Huber Point Needle
- 2x 3ml Syringe
- 1x 2.5ml Sterile Saline in 3ml Syringe
- 1x 2ml T-FloLoc in 12ml Syringe

- NOR-SFK-20** 20g Sub Flush Kit (Case of 5)

## T-FloLoc

2% Tetra-EDTA Flush and Lock Solution

- NOR-TFL-1202** T-FloLoc™ 2ml 2% Tetra EDTA Solution in 12ml Syringe Box of 10



### Penrose Drains



Latex rubber. Use to maintain drainage from infected wounds. Also useful to retract soft tissues such as blood vessels & nerves.

- 090168 Penrose Drain 1/4" 40cm 16" Long Sterile
- 090165 Penrose Drain 1/2" 40cm 16" Long Sterile

### Kitty Kollar Tube Collar

The placement of oesophagostomy 'E' feeding tubes is a growing modality in small animal medicine. Many 'E' Tubes have been successfully in place for years on some patients. The challenge of the 'E' Tube is its care & maintenance.

The Kitty Kollar was designed as a sensible solution to the everyday patient management of the 'E' Tube. The adjustable collar fits securely around the animal's neck. It has a small hole for the 'E' Tube to pass through. A velcro strap secures or holds the 'E' Tube flat when not in use. Circular cotton pads with a center hole are provided to be placed between the collar & the skin. They protect the wound & absorb drainage eliminating the need for owners to learn bandage techniques or repeated clinic visits for rebandaging. Includes 6 protector pads & laminated instruction card.

Code	Circumference of Neck in Inches	Length of Collar + Tab in Inches	Size
KTK-XS	4 - 7"	5.5" + 2"	X-Small
KTK-PF	8 - 9"	9" + 2"	Petite
KTK-F	10 - 12"	11" + 2"	Small
KTK-M	12 - 16"	13" + 3"	Medium
KTK-L	17 - 19"	18.5" + 3"	Large
KTK-XL	20 - 24"	21" + 3.5"	X-Large

- KTK-XS Kitty Kollar Tube Collar - X-Small
- KTK-PF Kitty Kollar Tube Collar - Petite
- KTK-F Kitty Kollar Tube Collar - Small
- KTK-M Kitty Kollar Tube Collar - Medium
- KTK-L Kitty Kollar Tube Collar - Large
- KTK-XL Kitty Kollar Tube Collar - X-Large
- KTK-PADS Spare Replacement Pads - Pack of 24

### Polyester Mesh

Use polyester mesh to repair soft tissue defects where alternative autografts are not available. E.g. perineal hernia, umbilical hernia. Mesh loop diameter 1mm. Sheet size 60mm x 120mm Supplied single pack sterile.

- PM60120 Polyester Mesh 60mm x 120mm Single

### Anal Sac Kit



Anal sac conditions such as impaction or abscess formation are a common, often reoccurring problem in small animal medicine. The surgical excision of both anal sacs can be elected as a permanent solution to these reoccurring issues.

- ASEK5 Anal Sac Excision Kit Pack of 5

### ENEMA Pump



The original Higginsons Enema Pump.

- G1894 Higginsons ENEMA pump

### Biopsy Needles

#### Soft Tissue Tru-Cut Style

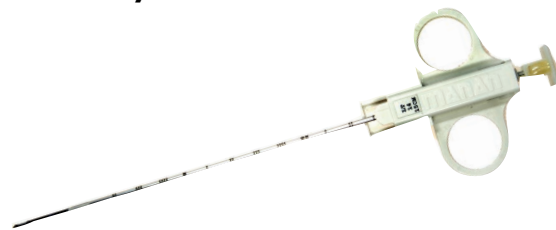

Used to sample liver, kidney & other soft tissues with minimal trauma. Takes just a small sliver of tissue. Supplied sterile - single use only. Needle is "locked" & when released, spring loaded cutting needle takes the biopsy. 14g has two stop system & can take either 10mm or 20mm samples.

- STB18 Vi Trucut Type Supercore Biopsy Needle 14g x 90mm
- STB18B Vi Trucut Type Supercore Biopsy Needle 18g x 90mm
- 012521 Trucut Soft Tissue Biopsy Needle Fully Manual 14g x 115mm

#### Temno Evolution Biopsy Needle



The standard soft tissue biopsy needle used by the NHS. 2 different sample sizes can be selected when pulling the plunger. One click equals a 10mm notch exposure, two clicks 20mm.

- TEM1420/1 Temno Evolution Biopsy Needle 14g x 200mm Single
- TEM1420/5 Temno Evolution Biopsy Needle 14g x 200mm 5 Pack

### Disposable Skin Biopsy Punch



Disposable skin biopsy punch with razor-sharp stainless steel blade. Light weight, ribbed plastic handle for control & comfort. 4mm, 6mm & 8mm diameters available. Supplied sterile.

- SBP4** Skin Biopsy Punch 4mm Diameter Head
- SBP6** Skin Biopsy Punch 6mm Diameter Head
- SBP8** Skin Biopsy Punch 8mm Diameter Head
- SBPSET** Skin Biopsy Punch Set of 3 (4mm, 6mm, 8mm)

### Flushing Needles

Flushing needles have a bead or olive soldered onto the tip to minimise trauma to friable soft tissues.

#### Ear Flushing Needles - Spreulls



Often referred to as Spreulls needles these blunt beaded needles are available in 60mm & 100mm lengths with a Luer hub.

- 012510** Ear Flushing Spreulls Needle Short 60mm
- 012511** Ear Flushing Spreulls Needle Long 100mm

#### Flushing Needle 21 Gauge



Suitable for anal gland ducts of small dogs. Ideal for flushing the urethra in the male cat prior to placement of catheter. Start with the 30mm needle & move to the 50mm & 75mm versions as urethra clears.

- 012512** Flushing Needle 21g Bead Tip 30mm
- 012512L** Flushing Needle 21g Bead Tip 50mm
- 012512XL** Flushing Needle 21g Bead Tip 75mm

### Oral Dosing Needles



Suitable for oral dosing & feeding of birds & reptiles. Available in a range of gauges from 12G to 23G. Care should be taken to ensure the needles cannot be swallowed.

- 012513** 12g Oral Dosing Needle 200mm Curved
- 012514** 14g Oral Dosing Needle 125mm Curved
- 012515** 16g Oral Dosing Needle 75mm Straight
- 012515C** 16g Oral Dosing Needle 75mm Curved
- 012515STR** 16g Oral Dosing Needle 100mm Straight
- 012516** 18g Oral Dosing Needle 50mm Straight
- 012516C** 18g Oral Dosing Needle 50mm Curved
- 012517** 20g Oral Dosing Needle 38mm Straight
- 012517C** 20g Oral Dosing Needle 38mm Curved
- 012517CS** 20g Oral Dosing Needle 25mm Curved
- 012517S** 20g Oral Dosing Needle 25mm Straight
- 012527** 22g Oral Dosing Needle 38mm Straight
- 012527C** 22g Oral Dosing Needle 38mm Curved
- 012522** 23g Oral Dosing Needle 25mm Straight
- 012532** Raptor Crop Tube 7mm Diameter 18cm Long

### Interosseus Infusion Needle 18g



Where vascular access is difficult, fluids & most drugs can be administered via this interosseus infusion needle. This process is particularly useful in neonates & birds where blood vessels are very small.

The most common site is the proximal femur via the trochanteric fossa. An IV catheter should be placed as soon as practical. Also used as a small bone marrow aspiration needle in the Jamshidi Style.

- BMBJV18** Interosseus Infusion Needle 18g

## V.A.C.<sup>®</sup> Therapy

Please note the VAC unit has been discontinued by the manufacturer, we will continue to supply consumables while stock is still available.



Dressings sizes (unless stated):

- Small = 10x7cm
- Medium = 18x12cm

For more information on dressing management see the V.A.C.<sup>®</sup> Therapy for Veterinary Use User Manual or the Quick Start Manual, both available on request.

- KCIM8275051/5** V.A.C.<sup>®</sup> GRANUFOAM™ Small Dressing Kit - Pack of 5
- KCIM8275052/5** V.A.C.<sup>®</sup> GRANUFOAM™ Medium Dressing Kit - Pack of 5
- KCIM8275052/1** V.A.C.<sup>®</sup> GRANUFOAM™ Medium Dressing - Single
- KCIM8275096/5** V.A.C.<sup>®</sup> GRANUFOAM SILVER™ Medium Dressing Kit x5
- KCIM8275096/1** V.A.C.<sup>®</sup> GRANUFOAM SILVER™ Medium Dressing Kit Single
- KCIM8275098/5** V.A.C.<sup>®</sup> GRANUFOAM SILVER™ Small Dressing Kit x5
- KCIM6275033/10** V.A.C.<sup>®</sup> WHITEFOAM™ Small Dressing - Pack of 10
- KCIM8275058/5** ACTIV.A.C.™ 300ml Canister With Gel - Pack of 5
- KCIM8275058/1** ACTIV.A.C.™ 300ml Canister With Gel - Single
- KCIM6275026/10** V.A.C.<sup>®</sup> Gel Strips - Pack of 10
- KCIM6275009/10** V.A.C.<sup>®</sup> Drape - Pack of 10
- KCIM6275009/1** V.A.C.<sup>®</sup> Drape - Single
- KCIM6275066/10** V.A.C.<sup>®</sup> Y-Connector
- KCIM8275057/10** SENSAT.R.A.C.™ Pad - Pack of 10
- KCIM8275057/1** SENSAT.R.A.C.™ Pad - Single
- KCI340037/5** Exhaust Charcoal Filter For Simplicity Unit - Pack of 5
- KCI340037** Exhaust Charcoal Filter For Simplicity Unit - Single

## Stomach Tubes



- EQSTS** PVC Stomach Tube Small 10mm Diameter
- EQSTM** PVC Stomach Tube Medium 15mm Diameter
- EQSTL** PVC Stomach Tube Large 20mm Diameter
- EQSTF** PVC Stomach Tube Foal

## Skin Stapler



- STAP35W** Skin Stapler 35W Sterile Single
- STAP35W5** Skin Stapler 35W Sterile Pack of 5

## Skin Staple Remover



- STAPREM** Skin Staple Remover Single



## Email Marketing Service

Our marketing emails are designed to **educate**, to keep you up to date with what's new at Vi & share **exclusive offers & discounts**.

Sign up today by scanning the QR code below.





Exclusively available from Vi®

VETIGEL® is a haemostatic gel that is designed to stop moderate to severe bleeding within seconds. VETIGEL® helps control bleeding in animals by achieving haemostasis in seconds without the need for manual pressure.

VETIGEL® can be used on a variety of procedures, including but not limited to: dental extractions, oral mass removals, abdominal and thoracic mass removals, soft organ biopsies, enucleations, spays & neuters, amputations, venous & arterial bleeds, cholecystectomies, catheterisation, and lacerations.

**VETIGEL® Haemostatic Gel**



- VET-02** VETIGEL Haemostatic Gel 2 x 5ml
- VET-05** VETIGEL Haemostatic Gel 5 x 5ml

**VETIGEL® Accessory Packs**



- ACC-01** VETIGEL Haemostatic Gel 2 x Accessory Packs

**Lyostypt®**



Lyostypt® is a wet-stable collagen haemostat. Collagen leads to thrombocyte adhesion & to activation of coagulation factor XII. 30 x 50mm. 12 units per pack.

- Achieves haemostasis very swiftly
- Is completely absorbable
- Can be removed easily
- Can be applied endoscopically
- Can be combined with fibrin glue & antibiotics

**1069128** Lyostypt® (12 Units)

# Ophthalmic



To view the Ophthalmic section of our website, please scan the QR code:



## Ophthalmic Kit



The kit contains 10 instruments. All are contained in a stainless steel case with a protective silicone lining which minimises damage to the delicate instruments. As recommended by David Williams MA VetMB PhD CertVOphthal.

Basic ophthalmic surgery kit contents:

014175	Castroviejo's TC Needleholder With Catch 150mm	x1
014108	Stevens Tenotomy Scissors 110mm Str	x1
014210S	Castroviejo's Corneal Scissors 115mm Str	x1
014191	Colibri Barraquer Forceps	x1
014162	Graefe Fixation Forceps	x1
014132	Roberts Tying Forceps 100mm	x1
014110	Barraquers Speculum Blade 30 x 10mm	x1
103175	Halstead Mosquito Artery Forceps 125mm Str	x1
103225	Halstead Mosquito Artery Forceps 125mm Cvd	x1
06054	Fine Beaver Type Scalpel Handle 130mm	x1
BX201040	Instrument Box 200 x 100 x 40mm	x1
BXSIL201040	Silicone Insert for Box For 200 x 100mm Instrument Box	x1

**014130** Basic Ophthalmic Surgery Kit

## Needle Holders

### Castroviejo



Classic ophthalmic needleholder with catch. Infrequent ophthalmic surgeons should also consider Miniature Fosters or Ryders as the squeeze action of Castroviejoes requires patience & practice to master. Also available without catch.

**014175** Castroviejo Needle Holders With Catch T.C. 150mm

**014177** Castroviejo Needle Holders Without Catch T.C. 150mm

### Castroviejo Needle Holders/Scissor



This Instrument functions as a standard Castroviejo needleholder but the jaws incorporate a suture cutting function in the style of Olsen Hegars or Gillies. Jaws are tungsten carbide for maximum grip.

**014181** Castroviejo Needle Holders/Scissor Str T.C. 150mm

**014182** Castroviejo Needle Holders/Scissor Cof T.C. 150mm Cof

**014183** Castroviejo Needle Holders/Scissor Str 'S'Cut T.C. 150mm

**014184** Castroviejo Needle Holders/Scissor Cof 'S'Cut T.C. 150mm



## Loan Kits

For a nominal fee, we have a range of **specialist loan kits** available to complement your own fleet. With next working day availability, the service offers flexibility as procedures are booked with your clients.

To find out more, scan the QR code below.



### Miniature Foster Gillies



602710 Miniature Foster Gillies T.C. 100mm 4"

### Ryder Needle Holders



Ideal for small needles. The smaller sizes are an alternative for ophthalmic needleholders.

- 606340 Ryder (Micro) T.C. Jaws 12.5cm 5"
- 606345 Ryder (Micro) T.C. Jaws 15cm 6"
- 606350 Ryder (Micro) T.C. Jaws 18cm 7"

### Derf Needle Holder



The Derf needle holder is a small T.C. needleholder with slightly heavier jaws than the Ryder. More resistant to surgeon abuse!

607010 Derf Needle Holder T.C. Jaws 12cm

### Roberts Tying Forceps

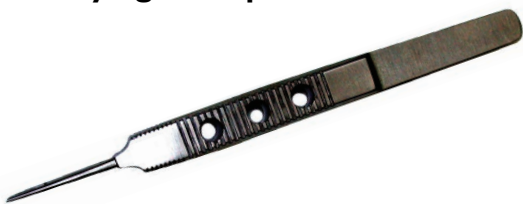

Used in conjunction with the needle holders to tie knots in fine material.

014132 Roberts Tying Forceps 100mm

### Eyelid - Speculae Desmarres Eyelid Retractor



- 014215-M Medium 14mm Wide 140mm
- 014215-L Large 16mm Wide 140mm

### Lister Speculum



This speculum is adjustable & has a locking mechanism. The shape is contoured for minimum interference with sutures & instruments.

014115 Lister Speculum 40mm Gape 80mm Length

### Barraquer Speculum

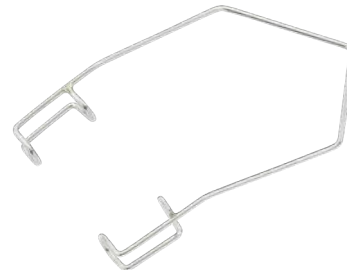

This simple spring loaded speculum is ideal for most procedures which do not require a locking speculum. No protuberances to catch sutures.

- 014110 Barraquer Speculum Large 30mm Gape 10mm 'Blade'
- 014112 Barraquer Speculum Small 25mm Gape 5mm 'Blade'

### Jaeger Eyelid Speculum



Useful during wedge resections of eyelids. The speculum stretches & retains the eyelid prior to dissection, with the blade cutting down onto the metal of the speculum which protects the eye.

- 014120 Jaeger Eyelid Speculum (Stainless) 100mm
- 014121 Jaeger Eyelid Speculum Insulated 110mm

## Ophthalmic Forceps

### Castroviejo's Corneal Forceps



014190 Castroviejo's Corneal Forceps 105mm Long

### St Martins Corneal Forceps



014160 St Martins Corneal Forceps

### Colibri (Barraquers) Forceps



014191 Colibri (Barraquers) Forceps 75mm Long

### Graefe Iris Forceps



014195 Graefe Iris Forcep Serrated 105mm Long  
014196 Graefe Iris Forceps Straight 1/2 Teeth 105mm Long

### Graefe Fixation Forceps



014162 Graefe Fixation Forceps 3.5mm Jaws 105mm Long

### Arruga Capsule Forceps



014150 Arruga Capsule Forceps 100mm Long

### Bennet's Cilia Forceps



Favoured by some surgeons the circular tips give good focal grip of individual cilia.

342460 Bennets Cilia Forceps 80mm Long

### Epilation Forceps



342450 Epilation Forceps Square Jaws Plain

### Bishop Harmon Forceps



014163 Bishop Harmon Forceps 1/2 Teeth 90mm



## Ophthalmic Scissors

### Pooley's Conjunctival Scissors



**746350** Pooley's Conjunctival Scissors 85mm Long

### Castroviejo Corneal Scissors



Squeeze action, very delicate scissor used to extend the stab corneal incision.

**014210** Castroviejo Corneal Scissors Cof 115mm Long  
**014210S** Castroviejo Corneal Scissors Str 115mm Long

### Strabismus Scissors



Stronger than corneal & conjunctival scissors, strabismus scissors are suitable for cutting muscles & skin.

**746900** Strabismus Scissors Str 90mm  
**747010** Strabismus Scissors Cof 90mm  
**746910** Strabismus Scissors Str 110mm  
**747020** Strabismus Scissors Cof 110mm

## Iris Scissors



A useful general purpose ophthalmic scissor. Lightweight, standard action scissor for conjunctiva & less satisfactorily, the cornea. Very rarely used on the iris in veterinary ophthalmology.

**744100** Iris Scissors Str 90mm  
**744120** Iris Scissors Cof 90mm  
**744110** Iris Scissors Str 115mm  
**744110L** Iris Scissors Str 115mm Left Handed  
**744130** Iris Scissors Cof 115mm  
**744130L** Iris Scissors 115mm Cvd Left Handed  
**744131** Iris Scissors Tungsten Carbide Str 115mm

## Steven's Tenotomy Scissors



**014108** Steven's Tenotomy Scissors Straight 110mm Long  
**014108CV** Steven's Tenotomy Scissors Curved 110mm Long

## Eye Enucleation Scissors



Standard curved surgical scissors do not match the radius of the eye of dogs & cats.

The eye enucleation scissor closely matches required radius & slides easily behind the eyeball to cut the optic nerve & internal ophthalmic artery & vein, without the requirement to apply dangerous traction to the globe. Use in conjunction with eye enucleation forceps.

**014225** Eye Enucleation Scissors 140mm

### Eye Enucleation Forceps



It is very important to clamp & crush the optic nerve & internal ophthalmic artery & vein.

The curvature on standard artery forceps is not correct & if used, the handles stand up in the way. The Enucleation Forceps are designed to slide around the rear of the globe & capture the blood vessels. The jaws are then levered against the edge of the orbit to elevate the globe for ease of tying. The handles curve out of the way.

Use with eye enucleation scissors. The large size is more suitable for large animal work.

- 014219 Eye Enucleation Forceps 135mm
- 014219L Eye Enucleation Forceps Large 155mm

### Chalazion Forceps (Desmarres)



- 014216 Chalazion Forceps (Desmarres) 3.5"

### Snellen's Vectis



Use to apply pressure to globe to extrude lens rather than 'fishing' for it within the eye.

- 014101 Snellen's Vectis 135mm

### Kimura Spatula



Use to apply pressure to globe to extrude lens rather than 'fishing' for it within the eye.

- 014103 Kimura Platinum Spatula 145mm

### Distichiasis Clamp



- 014113 Distichiasis Clamp 170mm

### Punctum Dilator



- 014116 Nettleship Dilator Single Ended 100mm
- 014117 Castrovejo Double Ended Punctum Dilator 130mm

### Lachrymal Cannulae



- 014221 Harrison Butler Lachrymal Cannula Curved 40mm



- 014224 Lachrymal Cannula Straight Stainless Steel

### Rabbit Nasolachrymal Duct Cannulae



- 012523 Nasolacrimal Duct Cannula 19 Gauge
- 012524 Nasolacrimal Duct Cannula 21 Gauge
- 012525 Nasolacrimal Duct Cannula Set 21 & 19G

# Dental



To view the Dental section of our website, please scan the QR code:



## Dental Elevators

### Elevator or Luxator?

**Elevator.** A stocky strong blade used to extract loose teeth using adjacent sound teeth. Not usually meant to go below the gumline. The elevator has a thicker, more robust chisel-shaped working tip. This instrument can be used as a prying lever, or with rotation, or in a 'wheel and axle' manner, to achieve displacement of the tooth root. Very high forces can be generated so fingertip manipulation only is appropriate.

They will fracture if the periodontal ligament fibres are not loosened or cut before forceps are applied or if the instrument is torqued.

**Luxator.** A razor sharp, thin-tipped wedging instrument used to cut the periodontal ligament and create a wedging force. The luxator is a fine instrument and is at risk of damage if used incorrectly. It is not to be used in a prying or twisting motion. It will blunt quickly and sharpening before each use is appropriate.

### Comfort Handle Elevators



Designed & developed by David Strong MRCVS, this popular pattern fits into the palm of the hand allowing the fore finger to be positioned along the shaft for added control.

Supplied with fully autoclavable coloured-coded PTFE handle. Available singly or as a set. When purchased as a set the stainless steel autoclave case comes free.

- 012601 Comfort Elevator 1mm (White)
- 012602 Comfort Elevator 2mm (Green)
- 012603 Comfort Elevator 3mm (Blue)
- 012604 Comfort Elevator 4mm (Black)
- 012600 Comfort Elevators Set of 4 (Includes Free Stainless Steel Case)
- 012605 Comfort Elevator 5mm (Grey)
- 012606 Comfort Elevator 6mm (Yellow)
- 012608 Comfort Elevator Set of 6 (Includes Free Stainless Steel Case)

### Comfort Handle Winged Elevators

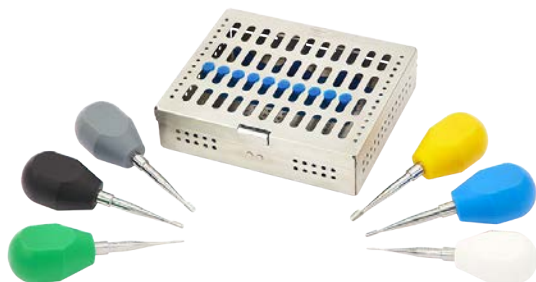

- 012611 Comfort Winged Elevator 1mm (White)
- 012612 Comfort Winged Elevator 2mm (Green)
- 012613 Comfort Winged Elevator 3mm (Blue)
- 012614 Comfort Winged Elevator 4mm (Black)
- 012610 Comfort Winged Elevators Set of 4 (Includes Free Stainless Steel Case)
- 012615 Comfort Winged Elevator 5mm (Grey)
- 012616 Comfort Winged Elevator 6mm (Yellow)
- 012618 Comfort Elevator Set of 6 (Includes Free Stainless Steel Case)
- 012617 Comfort Winged Elevator 7mm (Red)
- 012619 Comfort Winged Elevator 8mm (Purple)

## Winged Elevators



Veterinary Elevators designed by Dr Robert Wiggs. They have short winged blades with lateral edges which curve upwards further than traditional elevators, improving conformation to the root structure as well as instrument control. The narrow neck enhances visibility of the root & the shorter shaft improves handling & control, especially if the operator's hands are not large.

The design incorporates the best parts of an elevator & a luxator. Aluminium knurled handles are very comfortable in use. Flattened surface prevents rolling off the table.

Available singly or as a set of 4 in stainless steel autoclave case.

- 012389 Winged Elevator 1mm (Pink) 145mm
- 012390 Winged Elevator 2mm (Gold) 145mm
- 012391 Winged Elevator 3mm (Blue) 145mm
- 012392 Winged Elevator 4mm (Black) 145mm
- 012393 Winged Elevators Set of 4 (Includes Free Stainless Steel Case)
- 012395 Autoclavable Stainless Steel Case For Winged Elevators

## Winged Elevators With Short Handles



Our short handled winged elevators are predominantly designed to support users with smaller hands. The stainless steel case is silicone lined to minimise damage to the elevators, whilst being a convenient storage device during the sterilisation & transportation of the elevators.

- 012401 Short Winged Elevators Rainbow 1mm 125mm
- 012402 Short Winged Elevators Gold 2mm 125mm
- 012403 Short Winged Elevators Slate 3mm 125mm
- 012404 Short Winged Elevators Black 4mm 125mm
- 012405 Short Winged Elevators Set of 4 In Stainless Steel Case

### Wedge Elevator



Designed to remove the carnassial without the need to split the tooth.

012010 Wedge Elevator 170mm

### Small Feline Elevator



The 2mm angled tip on a fine handle allows access to lingual surfaces. Also useful in the extraction of rabbit incisors.

012018 Small Feline Elevator 165mm

### Superfine Elevator



012004 Superfine Elevator 2mm Straight

### Double Ended Elevator



The curved tips are designed to follow the concave and convex curvatures of the roots, helping to prevent breaking the roots.

012036 Double Ended Elevator 2mm 185mm

012038 Double Ended Elevator 4mm 190mm

### Molt Periosteal Elevator



The molt is a double ended periosteal elevator. The tips are round & dished. 4mm & 6mm diameters.

001275 Molt Periosteal Elevator 200mm

### Periosteal Elevator



Used for raising full thickness mucogingival flaps before surgical extraction of teeth, bone removal & sectioning.

001270 Periosteal Elevator 4mm/7mm 195mm

7350/05 Freer Periosteal Elevator 5mm 180mm

001271 AO Type Periosteal Elevator PTFE Handle Curved Tip 6mm 180mm

001272 Periosteal Elevator Very Fine 2mm/3mm 180mm Long

### Carnivore Elevator



Thin and very sharp. Used to remove tooth root fragments.

012001 Carnivore Elevator No. 1 (2.5mm) 145mm

012002 Carnivore Elevator No. 2 (3.5mm) 150mm

012003 Carnivore Elevator No. 3 (4.0mm) 150mm

012001/4S Set of Carnivore Elevators Nos. 1, 2, 3 & Wedge Elevator

### Apical Elevator



Used to remove tooth root fragments.

012006 Heidbrink Apical Elevator 145mm

### Couplands Elevators



This is the standard human elevator.

012015 Couplands Chisel No. 1 (3.0mm) 150mm

012016 Couplands Chisel No. 2 (4.0mm) 150mm

012017 Couplands Chisel No. 3 (5.0mm) 150mm

## Dental Luxators

### Forte Luxators



- 012174 Forte Luxator 2.5mm Black/Green 160mm
- 012175 Forte Luxator 3.2mm Black/Grey 160mm
- 012176 Forte Luxator 4mm Black/Brown 160mm
- 012172 Forte Luxator Set of 3
- FIXUS1 Luxator Autoclave Case

### Luxators



- 012177 Luxator 1mm Straight 160mm
- 012190 Luxator 2mm Straight 160mm
- 012191 Luxator 3mm Straight 160mm
- 012192 Luxator 3mm Curved 160mm
- 012194 Luxator 5mm Straight 160mm
- 012195 Luxator 5mm Curved 160mm
- 012192/CA Luxator 3mm Contra Angle 160mm
- 012196VET Veterinary Luxator Set of 5 With Stone

## Periodontal Instruments

### Periodontal Hand Instrument Set



Seven periodontal instruments in a stainless autoclave case.

Instruments include: mirror, shepherd hook explorer/measuring probe, straight curette scaler; angled curette scaler; angled Jaquette scaler plus two fine probes.

- 012210 Periodontal Instrument Set In Autoclave Case

### Hoe Periotome



- 012105 Hoe Periotome Double Ended

### Explorer/Measuring Probe



The Shepherd's Crook Explorer is used to test tooth stability & the condition of the gum margins.

The depth of these sulci are measured using the measuring probe.

- 012100 Shepherd's Crook Explorer/ Measuring Probe 170mm

### Subgingival Curette



This scaler is used to remove subgingival tartar & to plane tooth roots. The back surface of the scaler is blunt to minimise damage to the sensitive gingiva. The instrument is double-ended & has a balanced grip for extra comfort in use.

- 012130 Subgingival Curette 170mm

### Jaquette Supragingival Scaler



This scaler is used to remove tartar from above the gum margin. The tip & back of the instrument is sharp to scrape between teeth. Do not use below the gum margin. Double-ended with a balanced grip handle for ease of use & comfort.

- 012120 Jaquette Supragingival Scaler 170mm

### Hoe Scaler



Useful for removal of large areas of tartar & plaque from flat tooth surfaces.

- 012110 Hoe Scaler 165mm

### Double-Ended Scraper



The tips of this instrument are of familiar design mounted in a comfortable handle. One end is a fine hook to remove tartar from between teeth, the other is a shallow scoop to break tartar from flatter surfaces.

- 012020 Double-Ended Scraper 175mm

## Gracey Double Ended Curette



- 012135 Gracey Double Ended Curette 7/8
- 012136 Gracey Double Ended Curette 13/14
- 012137 Gracey Root Plane Curette Double Ended 1/2
- 012138 Gracey Root Plane Curette Double Ended 13/14

## Tartar Scrapers

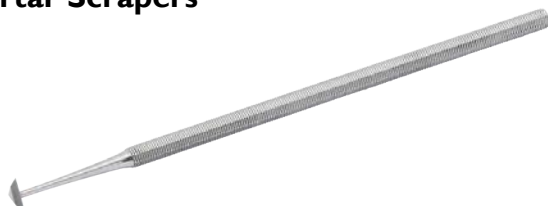

Traditional style dental scraper.

- 012024 Single Ended Scraper 16 160mm

## Dental Forceps

### Tartar Forceps



Our spring loaded tartar forceps are designed to sit comfortably in the hand to enable the veterinary dentist to remove bulky deposits from teeth.

- 012050 Tartar Forceps Spring Loaded 180mm
- 012051 Tartar Forceps Spring Loaded Cat Size 150mm
- 01205SET1 Tartar Forceps Set of 2 (As above)

### Tartar Forceps Cupix Point



These tartar forceps are designed specifically for the removal of bulky tartar prior to scaling & polishing.

One jaw is cup shaped to locate onto the tooth tip & act as a fulcrum for the other jaw. The other jaw is a sharp hook to engage the tartar at the gum margin.

The jaws are designed to remove tartar from both flat surfaces & between teeth.

- 012052 Tartar Forceps Cupix Point Style 180mm
- 012053 Tartar Forceps Cupix Point Style 150mm
- 01205SET2 Tartar Forceps Set of 2 (As above)

## Hawksbill Forceps



The multi-rooted teeth of the dog & cat should be loose before extraction by forceps.

The loosening may be due to dental disease or careful elevation. As well as firmly gripping the tooth to be extracted, appropriate dental forceps should support the tooth structure.

The Hawksbill forceps are designed specifically for the extraction of multi-rooted teeth in the dog & cat.

- 012030 Large Hawksbill Forceps 170mm
- 012040 Small Hawksbill Forceps 140mm
- 01204SET Hawksbill Forceps Set of 2 (As above)

## Small Incisor Forceps



The tips of these forceps are ideal for the removal of single rooted, usually incisor teeth. Cross-hatched thumb area for extra control. Tips meet.

- 012070 Small Incisor Forceps 150mm

## Narrow Tipped Extraction Tooth Forceps



A narrow tipped extraction forcep which meets at the tip to facilitate holding the tooth. Forceps are only used once the tooth has been loosened correctly, trying to forcibly extract without loosening will usually result in root breakage. Very useful for cats.

- 012072 Narrow Tipped Extraction Tooth Forceps

### Vi Extraction Forceps



Vi extraction forceps are well suited to extraction of medium to large teeth. The jaws have fine serrations for increased grip. As with all extractions it is important that the tooth involved is suitably elevated prior to the use of forceps. The teeth of our patients are much more tightly bound to the jaw than are human teeth.

- 012091 Vi Extraction Forceps Straight
- 012092 Vi Extraction Forceps Curved
- 012093 Vi Extraction Forceps Angled
- 012090 Vi Extraction Forceps Set of 3 (As above)

### Root Fragment Set



Removal of fragmented roots can be a challenge particularly if the roots themselves are healthy. A combination of elevation & forcep work is usually required. The set of 3 forceps with differing jaw angles covers all situations. The handles are anatomical & ergonomic.

- 012075 Root Fragment Forceps Set of 3

### Lip Retractor



The lip retractor solves the problem of retracting the lip for clear access to the teeth. It has a modified shape to prevent pinching the lip & the tips of the instrument are plastic-coated to minimise trauma. It can be adjusted by lightly bending. Autoclavable.

- 010147 Lip Retractor 160mm

### Dental Mirrors



- 012028 Mirror Handle Cone Socket Single Ended
- 012029 Dental Mirror No.3 With Cone Socket
- 012031 Dental Mirror Complete

### Mouth Gags & Wedges

#### Grays Mouth Gag



Simple action with spring to gently hold the jaws open.

- 012158 Hamilton Kirk Cat Gag Maximum Gape 40mm
- 012160 Grays Mouth Gag Small Maximum Gape 65mm
- 012170 Grays Mouth Gag Medium Maximum Gape 100mm
- 012180 Grays Mouth Gag Large Maximum Gape 140mm
- 012159 Grays Mouth Gag Set of 3

#### Smith Baxter Mouth Gag



Spring action maximises access but is less likely to overstretch the TMJ.

- 012795ES Smith Baxter Mouth Gag Extra Small Max Gape 5.5cm
- 012795S Smith Baxter Mouth Gag Small Max Gape 6.5cm
- 012795M Smith Baxter Mouth Gag Medium Max Gape 10cm
- 012795L Smith Baxter Mouth Gag Large Max Gape 14cm
- 012795EL Smith Baxter Mouth Gag Extra Large Max Gape 15.5cm
- 012795 Smith Baxter Mouth Gags Set of 5 (As above)

#### Mouth Wedge



The mouth wedge provides a simple effective means of holding the mouth open for routine dental procedures.

- 012790 Mouth Wedge Small
- 012791 Mouth Wedge Large
- 012795SET Mouth Wedge Set of 2 (As above)



## Dental Chart Labels

### Dental Chart Labels for Cats & Dogs

012200 Dental Chart Labels for Dogs Pack of 50

012201 Dental Chart Labels for Cats Pack of 50

## Dental Burs

Head Shape	Diameter (Approx)	Carbide 5 Pack	Diamond 5 Pack
Small Round	0.5	5FG 1/4	
Medium Round	1.4	5FG4	5FG4D
Large Round	1.8	5FG6	5FG6D
Extra Large Round	2.1	5FG8	
Extra Small Taper Fissure	0.8	5FG698	
Small Taper Fissure	1.2	5FG701	
Small Taper Fissure Long Head	1.2	5FG701L	
Medium Taper Fissure	1.6	5FG702	5FG702D
Medium Taper Long Head	1.6	5FG702L	FG702LD
Extra Small Flat Fissure	0.9	5FG556	
Small Flat Fissure	1.0	5FG557	

### Table Top Rabbit Gag



This version of our well known gag has a white PTFE platform which makes the gag warmer for the anaesthetised small patient. It is easy to clean & may be autoclaved.

- 012207 Table Top Rabbit Gag
- 012209 Table Top Rabbit Gag & LED Light
- DENRODKIT Table Top Rabbit Gag LED Light & Full Hand Kit (Rod2)

### LED Light For Table Top Gag

Illumination of the inside of the rabbit mouth is difficult without the hands of the surgeon getting in the way.

The rabbit gag LED light simply clips into the retaining mount which screws onto the threaded height-adjustment control. The flexible neck of the light can be adjusted for best effect. The powerful white LED lasts for approximately 100 hours on a set of AAA batteries.



- 012208 LED Light With Flexible Neck (Inc Clip)

### Rabbit Dental Kits



#### Basic Kit (ROD1) contains:

012185	Rodent Mouth Gag	x1
012189A	Cheek Dilator Large Long Reach	x1
012197CR	Crossley Incisor Luxator	x1
012186	Rodent Molar Cutter	x1
012181	Rodent Rasp Small	x1
BX201040	Stainless Steel Box 200x100x40mm	x1

#### Full Hand Kit (ROD2) contains:

012185	Rodent Mouth Gag	x1
012188	Rodent Cheek Dilator Small	x1
012189	Rodent Cheek Dilator Large	x1
012189A	Cheek Dilator Large Long Reach	x1
012197CR	Crossley Incisor Luxator	x1
012197M	Crossley Molar Luxator	x1
012199	Molar Extraction Forceps	x1
012186	Rodent Molar Cutter	x1
012184	Rodent Spatula	x1
012181A-A	Molar Rasp Fine - Dlamond - Small	x1
BX201040	Stainless Steel Box 200x100x40mm	x1

#### Hand & Motor Kit (ROD3) contains:

001789	Diamond Disc (20mm)	x1
001791	Diamond Disc Safety Shield	x1
001792	Rabbit Bur Kit in Block (6 Burs)	x1
001793	Rabbit Bur Soft Tissue Protector	x1
012185	Rodent Mouth Gag	x1
012188	Rodent Cheek Dilator Small	x1
012189	Rodent Cheek Dilator Large	x1
012189A	Cheek Dilator Large Long Reach	x1
012197CR	Crossley Incisor Luxator	x1
012197M	Crossley Molar Luxator	x1
012199	Molar Extraction Forceps	x1
012186	Rodent Molar Cutter	x1
012184	Rodent Spatula	x1
012181A-A	Molar Rasp Fine - Diamond - Small	x1
BX201040	Stainless Steel Box 200x100x40mm	x1

This kit also requires a straight nose cone and air or electric drive power unit.

- ROD1 Basic Kit
- ROD2 Full Hand Kit
- ROD3 Hand & Motor Kit

## Rodent Mouth Gag



The rodent mouth gag is a must for any practice looking to complete the examination & treatment of rabbit molars.

**012185** Rodent Mouth Gag

## Lightweight Rodent Mouth Gag



**012185LW** Rodent Mouth Gag Lightweight  
**012185LWS** Rodent Mouth Gag Lightweight Small

## Rodent Cheek Dilators



The small dilator is also useful as a small gag for guinea pigs & chinchillas.

**012188** Rodent Cheek Dilator Small Max Gape 40mm Blade Length 15mm, Blade Width 10mm  
**012189** Rodent Cheek Dilator Large Max Gape 60mm Blade Length 22mm, Blade Width 15mm  
**012189A** Rodent Cheek Dilator Long Reach - Blade Length 36mm, Blade Width 11mm Use With Long Burs Max Gape 35mm

## Rodent Spatula



Use to deflect tongue & cheek to examine & treat molars.

**012184** Rodent Spatula

## Rodent Molar Rasp



The diamond coated rasps are designed to smooth off sharp edges without disturbing the delicate tooth roots. The small diamond rasp is contoured in two directions to enable it to sit nicely on top of the molars. Unsuitable for debulking but good for tidying.

**012187** Rodent Tooth Rasp Large 165mm  
**012181** Rodent Tooth Rasp Small 180mm  
**012182** Rodent Molar Rasp Fine - Diamond Large 165mm  
**012181A-A** Molar Rasp Fine - Diamond - Small  
**01218SET** Rodent Molar Rasp Set of 4 (As above)

## Double Ended Diamond Rasp



One end is concave to sit on & around the molars. The other end is flat. Each blade is 25mm long.

**012173** Double Ended Diamond Rasp 205mm

## Rodent Molar Cutter



Use to debulk or for trimming spurs & hooks.

**012186** Rodent Molar Cutter 180mm  
**012186/S** Rodent Molar Cutter Small 140mm  
**01218CUTSET** Rodent Molar Cutter Set of 2 (As above)

## Crossley Incisor Luxator



Designed by David Crossley to extract the very large rabbit incisors. Removal avoids the requirement for repeated cutting of overgrown maloccluded incisors. Shape of luxator matches tooth shape. A smaller version is available for guinea pigs & rats.

**012197CR** Crossley Incisor Luxator 195mm  
**012197R** Small Crossley For Guinea Pigs & Rats 190mm  
**012197SET** Crossley Incisor Luxator Set of 2 (As above)

### Crossley Molar Luxator



Designed to facilitate extraction of molars with a minimum of damage to the alveolus & surrounding soft tissue. One cutting blade is for insertion down buccal or lingual surface. The other end of the instrument is set at right angles to penetrate between molars.

012197M Crossley Molar Luxator 160mm

### Molar Extraction Forceps



There is very little space inside a rabbit mouth. These forceps are very slim & angled to fit in the mouth without totally obscuring the teeth.

012199 Rabbit/Guinea Pig Molar Forceps 160mm

### Root Tip Extraction Forceps



Most chronic abscesses around the head of a rabbit are related to infected tooth roots. Removal of the offending root is a prerequisite for successful treatment. Designed by Frances Harcourt-Brown these modified needleholders are used to locate & lock onto the root tip via the abscess.

012206 Root Tip Extraction Forceps 160mm

### Rabbit Bur Kit



Three burs have been selected by David Crossley as being suitable for the reduction of rabbit & chinchilla molar teeth. Our rabbit bur kit includes two of each bur in a stainless steel autoclavable block. All are HP fitting to fit into a 1:1 Straight Nose Cone (not included). When using the long bur (HL563) use the soft tissue protector to shield tongue & cheek.

The Rabbit Bur Kit in Block contains:

001792BLOCK.ONLY	Rabbit Burr Kit Block Only	x1
HL563	Very Long Cross Cut Flat Fiss (60mm)	x2
HP704	Taper Side Cut Bar 2.3mm	x2
HP8	Round Plain Cut 2.3mm Diameter	x2

001792 Rabbit Bur Kit In Block (6 Burs)  
001793 Soft Tissue Protector For Above Fits Straight Nose Cone  
Components of the kit are available separately.

### Cylindrical Sharpening Stone



To work effectively, both scalers & elevators need to be sharp. Regular sharpening will keep your instruments working correctly.

012146 Luxator Cylindrical Sharpening Stone

### Diamond Card - Fine



Diamond covered plate is ideal for sharpening dental elevators & luxators. To work efficiently these instruments must be sharp. An additional advantage is that the lubricant used is water rather than the oil used with sharpening stones.

012144 Flat Diamond Sharpening Card (Fine)

### Diamond Cone



Subgingival curettes must be kept sharp to work efficiently. They should be checked & sharpened at least weekly. The diamond cone is indestructible compared with stones which break very easily & uses water rather than oil as a lubricant.

012148 Diamond Cone 205mm

### Diamond Disc



001789 Diamond Disc 20mm  
001791 Diamond Disc Safety Shield

# General Clinical



To view the General Clinical section of our website, please scan the QR code.



## Modular Plating Box Components

### Modular Plating Box Base & Lid



**MPBB** Modular Plating Box Base  
**MPBL** Modular Plating Box Lid

### Modular Plating Box Instrument Trays



**MPBIT1520** 1.5/2.0mm MPB Instrument Tray  
**MPBIT24** 2.4mm MPB Instrument Tray  
**MPBIT2735I** 2.7/3.5mm MPB Instrument Tray 1  
**MPBIT27352** 2.7/3.5mm MPB Instrument Tray 2  
**MPBIT45** 4.5mm MPB Combined Instrument & Plate Tray

### Modular Plating Box TPLO Instrument Trays

**MPBITTPLO1** Instrument Tray 1 For TPLO Kits  
**MPBITTPLO2** Instrument Tray 2 For TPLO Kits  
**MPBITTPLO3** Instrument Tray 3 For TPLO Kits

## Modular Plating Box Plate Trays For Locking Plates



**MPBPTL15** 1.5mm MPB Plate Tray For Locking Plates  
**MPBPTL2** 2.0mm MPB Plate Tray For Locking Plates  
**MPBPTL24** 2.4mm MPB Plate Tray For Locking Plates  
**MPBPTL2735** 2.7/3.5mm MPB Plate Tray For Locking and Non Locking Plates

## Modular Plating Box Plate Trays For Non-Locking Plates

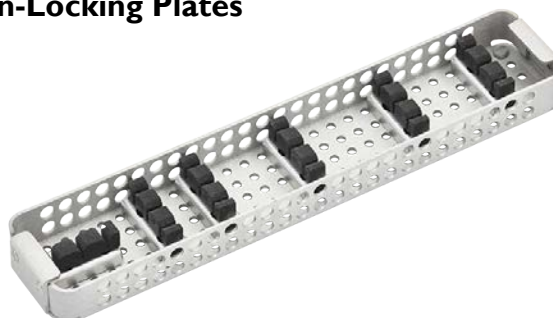

**MPBPTNL15** 1.5mm MPB Plate Tray For Non-Locking Plates  
**MPBPTNL2** 2.0mm MPB Plate Tray For Non-Locking Plates  
**MPBPTNL24** 2.4mm MPB Plate Tray For Non-Locking Plates

## Modular Plating Box Screw Caddies



**MPBSC15** 1.5mm MPB Screw Caddy  
**MPBSC20** 2.0mm MPB Screw Caddy  
**MPBSC24** 2.4mm MPB Screw Caddy  
**MPBSC27** 2.7mm MPB Screw Caddy  
**MPBSC35** 3.5mm MPB Screw Caddy  
**MPBSC45** 4.5mm MPB Screw Caddy

## Premium Boxes

### Premium Boxes With No Filters



Vi's range of premium instrument boxes are made from lightweight anodised aluminium. Both lid & base are perforated, but protected by replaceable filters which allow steam penetration but not micro-organisms. The clip on lid incorporates a silicone seal which is impervious to micro-organisms.

- BX301440P** Premium Instrument Box 300x140x40mm
- BX301470P** Premium Instrument Box 300x140x70mm
- BX301410P** Premium Instrument Box 300x140x100mm

### Premium Boxes With Reusable Filters



Premium Box supplied with reusable filter JK091.

- BX301440P-F** Premium Instrument Box 300x140x40mm With Filters
- BX301470P-F** Premium Instrument Box 300x140x70mm With Filters
- BX301410P-F** Premium Instrument Box 300x140x100mm With Filters

### Instrument Baskets for Premium Boxes



- PBBX26512045** Instrument Basket Without Lid For BX301470P 265x120x45mm
- PBBX26011570** Instrument Basket Without Lid For BX301410P 256x120x70mm
- PBBXINNERI** Perforated Tray with Lid For BX301410P 270x123x65mm

### Premium Box with Insert for Locking Kits



- LS20BOX** Premium Box With Insert For 2mm Locking Kit
- LS24BOX** Premium Box With Insert For 2.4mm Locking Kit
- LS27BOX** Premium Box With Insert For 2.7mm Locking Kit
- LS35BOX** Premium Box With Insert For 3.5mm Locking Kit

### Premium Box with Insert for Cortical Kits



- BXP01** Premium Box With Insert For 1mm Cortical Kit
- BXP152024** Premium Box With Insert For 1.5/2.0/2.4mm Cortical Kit
- BXP2735** Premium Box With Insert For 2.7/3.5mm Cortical Kit

### Premium Box with Insert for TTA Kit



- TTABOX** Premium Box With Insert For TTA Kit

### Filters and Labels for Premium Boxes



- BXPFILTER** Paper Filter Indicators For BX3014 Series Pack of 100
- JK091** Sterile Container Reusable Filter Pack of 2
- BXPFIND** Paper Labels With Indicators Pack of 100

### Disposable Padlocks with Indicator

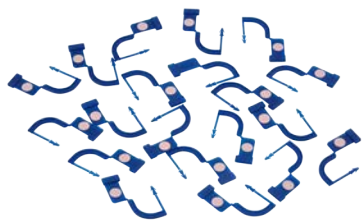

Anti-tamper security padlock with steam sterilisation indicator spot. Single use only. Padlock has to be broken to be removed.

- PSL20** Disposable Padlock With Sterilisation Pack of 20
- PSL100** Disposable Padlock With Sterilisation Pack of 100

### BBraun Disposable Padlocks with Indicator



- JG752** Container Padlocks with Steam Indicator Pack of 100

### Disposable Padlocks - Instrument Repair



Useful for marking instruments which should be sent for repair. Single use only. Padlock has to be broken to be removed.

- PSTR10** Disposable Padlocks - Instrument Repair Pack of 10

### Stainless Steel Instrument Boxes with Filters



Stainless Steel in construction with a bacterial filter in the base. The Filter allows steam to enter & water vapour to leave but excludes bacteria. Available in a range of sizes to suit most instrument sets & autoclaves.

- BX201040** Instrument Box 200x100x40mm
- BX221250** Instrument Box 220x120x50mm
- BX281450** Instrument Box 280x140x50mm
- BX341650** Instrument Box 340x165x50mm
- BX341670** Instrument Box 340x165x70mm
- BX402070** Instrument Box 400x200x70mm

### Filters for Stainless Steel Instrument Boxes



- FILBX201040** Filter For Box BX201040
- FILBX221250** Filter For Box BX221250
- FILBX221550** Filter For Box BX221550
- FILBX281450** Filter For Box BX281450
- FILBX341650** Filter For Box BX341650
- FILBX402070** Filter For Box BX402070

### Stainless Steel Instrument Boxes without Filters



Stainless steel solid box no filter

- BX201040NF** Instrument Box No Filter 200x100x40mm
- BX221250NF** Instrument Box No Filter 220x120x50mm
- BX281410NF** Instrument Box No Filter 280x140x100mm



- BX221550** Instrument Box No Filter 220x150x50mm

### Silicone Inserts

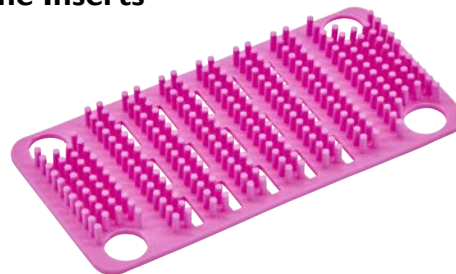

Autoclavable silicone insert fits the base of the stainless box to prevent instruments contacting & damaging each other. There is an insert to fit each of our standard boxes. Colour may vary.

- BXSIL201040** Silicone Insert For Box 200x100mm
- BXSIL2540** Silicone Insert For Box 250x150mm
- BXSIL2212** Silicone Insert For Box 220x120mm
- BXSIL2215** Silicone Insert For Box 220x150mm
- PBXS270125** Silicone Insert For Box 270x125mm
- BXSIL2814** Silicone Insert For Box 280x140mm
- BXSIL3416** Silicone Insert For Box 340x160mm



### Stainless Steel Box with Insert for Cortical Kits



- BX1520CS** Box Fitted For 1.5 & 2.0mm Cortical Screws & Equipment
- BX20CS** Box Fitted For 2.0mm Cortical Screws & Equipment
- BX24CS** Box Fitted For 2.4mm Cortical Screws & Equipment
- BX2735CS** Box Fitted For 2.7 & 3.5mm Cortical Screws & Equipment

### Autoclavable Needle Boxes



- 091149** Polypropylene Needle Box 50x40x8mm
- 091149L** Polypropylene Needle Box 95x70x17mm

### Stainless Steel Box with Insert for External Fixation



**001578** ESF Box With Partitions

### Power Tool Storage Acculan 4 Storage



Can be used with Acculan 4 small drill and TPLO saw. Other storage options are available on request.

- JF282R** Basket For JN096
- JF289R** Basket Lid For JF282R
- JF938** Silicone Mat Mesh Fitting 1/2 Basket
- JN096** Dental Sterile Container & Lid

### Stainless Steel Boxes



Design may vary from image.

- BX10030** Equipment Box 100mm Wide 30mm Deep
- LSPBOX** Box For Locking Screw Plugs
- 012395** Autoclavable Case For Winged Elevators

### Black Series Aluminium Sterilisation Cases

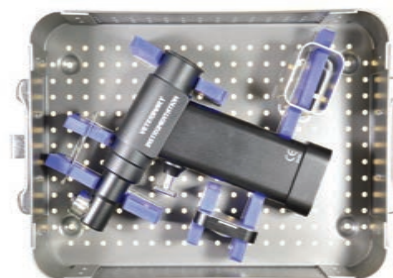

Designed specifically for the Vi Black Series Drill & Saw & suitable for use in larger autoclaves. Cases outer dimensions are 300x205x70mm.

- BLACKDRILL-SC** Sterilisation Case For Black Series Drill
- BLACKSAW-SC** Sterilisation Case For Black Series Saw

### Stainless Steel Screw Boxes

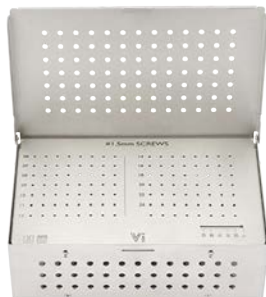

- SH1500** Screw Boxes For 1.5mm Screws
- SH2000** Screw Boxes For 2mm Screws
- SH2400** Screw Boxes For 2.4mm Screws
- SH2700** Screw Boxes For 2.7mm Screws
- SH2735** Screw Boxes For 2.7/3.5mm Screws
- SH3500** Screw Boxes For 3.5mm Screws
- SH4500** Screw Boxes For 4.5mm Screws
- SHTTA242735** Screw Box For TTA Screws 2.4/2.7/3.5mm

### Vi TPLO Saw Sterilisation Case



**VITPLOSAW-SC** VI TPLO Sterilisation Case

For Pin and Wire Storage See Page 135

## Instrument Cleaning Agents Rapidex Cleaner



An effective general surgical instrument cleaner. The soluble sachets are simply dropped into the ultrasonic bath.

- RAPIDEX** Rapidex Soluble Sachets Box of 50
- RAPIDEXBULK** Rapidex Bulk Powder 2.25kg

## Rapizyme



Easy to use measured bottle. 2ml per litre dilution. Removes all organic material. Ideal for endoscopes & low foam for ultrasonics. Completely rinsable & biodegradable.

- RAPIZYME1** Rapizyme 1 Litre

## Instrument Cleaning Brushes & Pipecleaners



Stainless Steel Instruments are protected from corrosion by a very thin layer of chromium oxide. This layer can be damaged by the use of brushes not designed for the purpose of cleaning surgical instruments, resulting in abrasions, surface marking and staining.

Instrument cleaning brushes are available with nylon & stainless bristles.

- CB1** Cleaning Brush Nylon For Gross Contamination
- CB2** Cleaning Brush Stainless For Large Burs & Reamers
- CB3** Cleaning Brush Nylon For General Instrumentation
- CB4** Cleaning Brush Stainless Steel For Orthopaedic Instruments
- CBPIPE** Pipe Cleaners 1/8" 12" Long (Pack of 100)

## Cylindrical Sharpening Stone



To work effectively, both scalers & elevators need to be sharp. Regular sharpening will keep your instruments working correctly.

- 012146** Luxator Cylindrical Sharpening Stone

## Diamond Card - Fine



Diamond covered plate is ideal for sharpening dental elevators & luxators. To work efficiently these instruments must be sharp. An additional advantage is that the lubricant used is water rather than the oil used with sharpening stones.

- 012144** Flat Diamond Sharpening Card (Fine)

## Diamond Cone



Subgingival curettes must be kept sharp to work efficiently. They should be checked & sharpened at least weekly. The diamond cone is indestructible compared with stones which break very easily & uses water rather than oil as a lubricant.

- 012148** Diamond Cone 205mm

## Instrument Marking Tape



Instrument marking tape is designed to help identify and organise instruments as they move between theatre and re-processing.

Available as a pack of 8 or in individual rolls.

- I00001** Instrument Marking Tape (Box 8 Colours) (1200mm)
- I00001Y** Instrument Marking Tape Single Yellow (3000mm)
- I00001R** Instrument Marking Tape Single Red (3000mm)
- I00001BR** Instrument Marking Tape Single Brown (3000mm)
- I00001OR** Instrument Marking Tape Single Orange (3000mm)
- I00001BLU** Instrument Marking Tape Single Blue (3000mm)
- I00001G** Instrument Marking Tape Single Green (3000mm)
- I00001W** Instrument Marking Tape Single White (3000mm)
- I00001GRY** Instrument Marking Tape Single Grey (3000mm)
- I00001P** Instrument Marking Tape Single Purple (3000mm)

### Protective Autoclavable Tips



Autoclaveable protective tips for pins and delicate or sharp instruments

- I00011-W** Protective Tip White Up To 1.6-2mm Diameter Pack 20
- I00011-BL** Protective Tip Blue 2.5-3mm Diameter Pack 20
- I00011-G** Protective Tip Green Up To 3.2-4mm Diameter Pack 20
- I00011-R** Protective Tip Red Up To 4.8mm Diameter Pack 20
- I00011-Y** Protective Tip Yellow Up To 6.0-6.5mm Diameter Pack 20
- I00011-O** Protective Tip Flat Orange Up To 10mm Wide Pack 20
- I00011-BR** Protective Tip Flat Brown Up To 16mm Diameter Pack 20
- I00011-BLK** Protective Tip Flat Black Up To 25mm Diameter Pack 20
- I00020** Protective Tips Silicone Multi Pack One Pack of Each Colour 160 (8x20)

### Skin Stapler



- STAP35W** Skin Stapler 35W Sterile Single
- STAP35W5** Skin Stapler 35W Sterile Pack of 5
- STAPREM** Skin Staple Remover Single

### Washable Kennel Liner



Constructed of 4 layers, a soft outer layer with highly absorbent and waterproof mid layers and a hard-wearing polyester backing. Machine washable up to 90 degrees and can be tumble dried on low heat.

- WKLINER1** Washable Kennel Liner - Bone
- WKLINER2** Washable Kennel Liner - Paw

### Reusable Cotton Drapes



- BDS3624** Plain Drape Balloon Cloth 910x600mm
- BDS3624DBL** Plain Drape Balloon Cloth Double 910x600mm
- BDS3636** Plain Drape Balloon Cloth 910x910mm

### Disposable Drapes



Each pack is supplied sterile and contains high quality disposable drape, hand towel, swabs, wrap and tape. Full details available upon request

- DPGENSURG** Sterile General Drape Pack
- DPORTHO** Sterile Orthopaedic Drape Pack
- DRAPE180** TRI Laminate Drape with Adhesive Edge 180x180
- DPSPAYSM** Sterile Spay Pack Small
- DPSPAYMED** Sterile Spay Pack Medium
- DPSPAYLEG** Sterile Spay Pack Large

### Disposable Iodine Drapes



- ID6650** Ioban Drape 560x450mm - Single
- 44040** Drape, Incise, 40x40cm Iodine ADH 34x40cm - Single
- 44040/10** Drape, Incise, 40x40cm Iodine ADH 34x40cm Pack of 10
- 42020** Drape, Incise, 20x20cm Iodine ADH 15x20cm -Pack of 20
- 42020/10** Drape, Incise, 20x20cm Iodine ADH 15x20cm - Pack of 10

### Disposable Gowns



Supplied as a single sterile high quality disposable gown with hand towel

- GPSMALL** Sterile Surgical Gown Size S
- GP MEDIUM** Sterile Surgical Gown Size M
- GPLARGE** Sterile Surgical Gown Size L
- GPXLARGE** Sterile Surgical Gown Size XL
- GPXXLARGE** Sterile Surgical Gown Size XXL

## Electrosurgery GIMA BiPolar Electrosurgery Unit 120 Watt

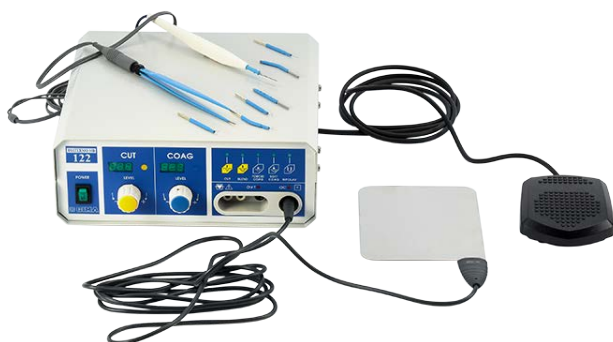

HF 122 is a high frequency electrosurgery unit suitable for microcoagulation, small and medium Monopolar surgery and BiPolar coagulation.

The following Monopolar modes of operation are available via the control panel: pure cutting (Cut), coagulated cutting (Coag), Monopolar coagulation and microcoagulation (Blend). Additionally with BiPolar forceps, bipolar coagulation and microcoagulation are available.

### Kit Includes:

- Two button Monopolar handle (autoclavable)
- Two button Monopolar handle (disposable)
- BiPolar cable and forceps
- Foot control
- Flat neutral plate
- 6 short Monopolar electrodes, as pictured below.

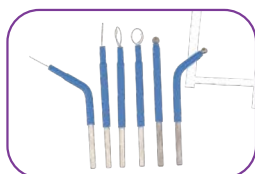

- HF122** 120 Watt Monopolar/ BiPolar Electrosurgery Unit
- HF30547** Spare Monopolar Handle Screw Grip For HF122
- HF123** 1mm Bipolar Dissecting Forceps 180mm Str F/HF122
- HF124** Spare Bipolar Cable For HF122 (A Type)
- HF30568** Spare Foot Pedal For HF122

## GIMA BiPolar Electrosurgery Unit 160 Watt



This unit is a higher-powered version of our popular HF 122 Unit.

The additional power availability comes into its own when working with mixed tissue densities such as in orthopaedics, and in more moist situations such as mucous membranes.

Modes of operation are pure cut, coagulated cut, forced coagulation, soft coagulation, and with bipolar forceps, bipolar coagulation.

HF160 has the same set of alarms as the 120, including open circuit which warns of a disconnected cable or poor patient plate contact and interrupts the HF emission for cut and coagulation.

All the standard accessories shown for the HF120 fit this unit. We can also supply an adaptor which allows standard 2 x 4mm banana plug (Valley Lab type) bipolar cables to be used with HF 160.

- HF160** 160 Watt Monopolar/BiPolar Electrosurgery Unit
- HF30642** BiPolar Cable Adaptor For Gima Unit HF160 to 2x4mm Banana Plugs

## BiPolar Dissecting Forceps

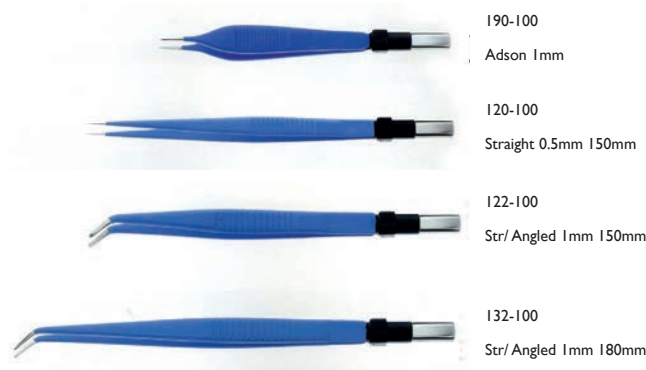

- HF190-100** Bipolar Forceps Adson 1mm Tip
- HF120-100** Bipolar Forceps Straight 0.5mm Tip 150mm Long
- HF122-100** Bipolar Forceps Straight/Angled 0.5mm Tip 150mm Long
- HF132-100** Bipolar Forceps Straight/Angled 1mm Tip 180mm Long

### BiPolar Cable Generator Terminations



**A** GIMA HF122  
**D** 4mm Banana Plugs  
 Valley Lab  
 Eschman  
 Arthrex OPES

These are the most common types of termination for the generator or machine end of the cable.

Our bipolar cables and forceps all have an EU fitting square end.

- HF124** Spare Bipolar Cable A Type EU Fitting Forcep Connector
- HFS-30** Spare Bipolar Cable D Type EU Fitting Forcep Connector
- HF30642** Bipolar Cable Adaptor

### Monopolar Spares and Accessories

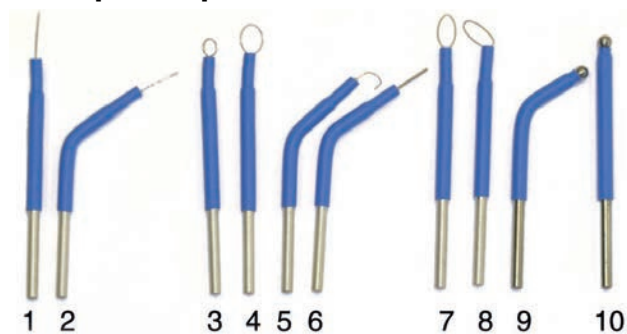

- HF1** Electrode
- HF2** Electrode
- HF3** Electrode
- HF4** Electrode
- HF5** Electrode
- HF6** Electrode
- HF7** Electrode
- HF8** Electrode
- HF9** Electrode
- HF10** Electrode
- HF11** Needle Electrode For Diathermy 70mm x 2.4
- HF1-10** Electrodes Mixed Set of 10
- HF12** 7cm Blade - Autoclavable
- HF30537** Scratch Pad (Supplied Sterile) Pack of 10
- HF30547** Spare Monopolar Handle Screw/Grip For HF122
- HF30563** Spare Cable For Gima Plate
- HF126** Spare Metal Plate For HF122 and HF106
- HF107** Autoclavable Monopolar Handle for HF106

### GIMA Smoke Evacuation Unit



The surgical smoke consists of water vapour, organic gas, visible or invisible solid particles and viral particles. The aspiration and filtration system eliminates bad smells, reduces the bacteriological and viral risks, whilst improving vision in the surgical field.

The Smoke Evacuation Starter Kit contains:

- HF30450** Electrosurgery Smoke Evacuation Unit x1
- HF30451** Smoke Evacuation ULPA Red Filter 20 hours x1
- HF30453** Aspiration Kit Pack of 6 x1
- HF30454** Handle Aspiration Kit Sterile Pack of 12 x1
- HF30578** GIMA Waterproof Foot Pedal 3m Cable x1

Kit components are available separately.

**HF20540START** Smoke Evacuation Starter Kit

### Cautery Units

#### Portable Cordless Cautery Kit



This handy set comprises a handpiece using two AA batteries (included) and four interchangeable and replaceable Cautery Tips

- 1/2"(12mm) Fine general purpose electrode for haemostasis
- 1/2"(12mm) Loop electrode for small skin tumours
- 4"(130mm) Fine electrode for deep areas
- 4"(130mm) Loop electrode

Tip temperature 2200°F/1200°C

- 02313** Portable Cordless Cautery Kit
- 02313W** Replacement Cautery Tip 1/2" Fine
- 02313X** Replacement Cautery Tip 1/2" Loop
- 02313Y** Replacement Cautery Tip 4" Fine
- 02313Z** Replacement Cautery Tip 4" Loop

### Askir Suction Machine



A simple suction unit with a 1 litre capacity bottle, which is adequate for virtually all small animal procedures. The in-line filtration system minimises biohazards.

- 185000** ASKIR 30 Suction Device
- 185002** Set Tubes and Filter for Suction Machine
- 185003** Filter Only
- 185004** Spare Suction Bottle and Lid
- 185005** Spare Lid for Suction Bottle

### Suction Tubing



- 185009** Autoclavable Suction Tubing Per Metre

### Suction Tubing Connector



- 185006** Suction Tubing Connector

### Hospivac Spares

- 185H210351** Spare Bottle For Hospivac 350
- 185H210353** Spare Bottle and Lid For Hospivac 350
- 185HSP0032** Spare Tubes and Filter For Hospivac 350
- 185HSP0121** Spare Filter For Hospivac 350
- 185HSP033** Spare Tubes For Hospivac 350

### Suction Tips

We stock the four most useful styles of tip. Each comes complete with a length of autoclavable silicone tube to connect to the suction unit.

#### Yankauer



General purpose suction tip for removal of large volumes e.g. from abdomen.

- 1854327** Yankauer Suction Tip

#### Poole



As Yankauer but more holes for greater volume uptake. With perforated outer sheath removed the Poole functions as a small bore straight suction tip.

- 1854330** Poole Suction Tip

#### Adson 4mm



Focal suction tip removes fluid from specific locations e.g. in spinal procedures. Very controllable at the handpiece by single finger over air bypass hole.

- 1852121** Adson Suction Tip 4.0mm

#### Frazier 2.6mm



As the Adson but finer still.

- 1854328** Frazier Suction Tip 2.6mm

# Patient Warming & Monitoring



To view the Patient Warming & Monitoring section of our website, please scan the QR code.



## AAS Darvall Warm Air System

The benefits of preventing hypothermia both during and after surgery are well documented, both in terms of improved patient care and more efficient use of resources.

Use of warm air blankets to pre-warm patients, heated anaesthetic circuits for all procedures plus blankets under anaesthetised animals during longer procedures, over 60 minutes, followed by post-op cage blanket use will help optimise patient recovery from anaesthesia.

## AAS Darvall Cozy Warm Air Heater



The Darvall Cozy™ Warm Air Heater is easy and straightforward to use. Running quietly, it is suitable for use both in theatres and recovery areas. The Darvall Cozy™ Warm Air Heater comes with a 24 month warranty.

The Darvall Cozy™ Starter Kit contains:

- Darvall Cozy™ Warm Air Heater Unit
- Wheel Kit - 4 Push Fit Wheels
- Sample Pack of Blankets (8 Blankets in total)
- Kennel Door Adaptor (Cwik)

**AAS9084** AAS Darvall Cozy™ Warm Air Heater System

## AAS Darvall Kennel Door Adapter

The KDA Kennel Door Adapter (Cwik):

- Connects Darvall Cozy Warm Air Heater to Darvall's Kennel Blankets
- Fits to most warm air heaters using Cozy KDA Heater Hose Adapter
- New Cozy Cwik™ locking system - no nuts or screws
- Twist-Connect system for easy installation
- Allows fast access to patients in kennels
- Rapidly moved between kennel doors
- Fits to most kennel door systems
- Safe warming for patients

The KDA Kennel Door Adapter (Cwik) Kit contains:

- 1x Cozy Cwik KDA Adapter
- 2x Cozy Cwik KDA Gaskets (1 spare)
- 1x Cozy KDA Extension Hose 25cm
- 1x Cozy KDA Universal Heater Hose Adapter
- 1x Cozy Blanket x 8 Sample Pack

**AAS9842** Darvall KDA Kennel Door Adapter Kit - Cwik

## AAS Darvall Warm Air Blankets - New Range

Innovative Warm Air Blankets for surgery, dentistry, exotics and kennels. Use for pre-warming, during anaesthesia and in recovery.

What makes them different from the rest?

The Darvall series of warm air blankets are specifically designed for veterinary use. The unique blanket surface design is porous polyester which provides low uniformly-distributed air flow, providing efficient warming, reducing the 'wind chill' factor and minimising hair contamination. Traditional warm air blankets have a punched out surface allowing a higher rate of air flow out of the blanket, much less suitable for veterinary patients.

The blankets are colour coded, the white side always is in contact with the patient.

## AAS Darvall Warm Air System Blankets

- AAS02979** Darvall Warm Air Surgery Under Blanket for Cats and Small Dogs - Pack of 10
- AAS02275** Darvall Warm Air Surgery Under Blanket For Medium and Large Dogs - Pack of 10
- AAS05310** Darvall Warm Air Dentistry Under Blanket/Surgery Over Blanket For Medium and Large Dogs - Pack of 10
- AAS02827** Darvall Warm Air Surgery/Cage Blanket For Exotics and Small Animals - Pack of 10
- AAS05360** Darvall Warm Air Single Kennel Blanket For Cats and Small Dogs - Pack of 10
- AAS05359** Darvall Warm Air Double Kennel Blanket For Medium and Large Dogs - Pack of 10
- AAS8460** Darvall Warm Air Sample Assorted Blankets - Pack of 10 (2 x 2979, 2 x 2275, 2 x 5360, 2 x 5359, 1 x 5310, 1 x 2827)



2827



5360



5359



5310



2979



2275

## AAS Darvall Cozy Warm Air Heater Accessories

- AAS9744** AAS Darvall Cozy™ Filter Replacement Kit
- AAS9707** AAS Darvall Cozy™ Heater Hose Cover (New Style)
- AAS9702** AAS Darvall Cozy™ Heater Hose (3-Pin Connector V1.0)
- AAS9979** AAS Darvall Cozy™ Heater Hose (4-Pin Connector V1.1)
- AAS1959** Darvall Two Kennel Y Adaptor (Requires 2x AAS9842 - Not Included)
- AAS9701** AAS Darvall Cozy™ KDA Extension Hose 1.5m
- AAS8130** AAS Darvall Cozy™ KDA Extension Hose 25cm
- AAS8577** AAS Darvall Cozy™ KDA Universal Heater Hose Adapter
- AAS9737** AAS Darvall Cozy™ Elbow Adapter (3-Pin Connector V1.0)
- AAS9981** AAS Darvall Cozy™ Elbow Adapter (4-Pin Connector V1.1)
- AAS9742** AAS Darvall Warm Air Heater Hose Clamp (New Style)

The Darvall Cozy™ Warm Air Heater Hose comes with a 12 month warranty.



## Darvall Heated Anaesthetic Starter Kit and Accessories



- AAS9855** Heated Circuits Starter Kit Complete With Lack Adapter
- AAS8347** Heated Smooth Wall Breathing Circuit 12mm Cats and Small Dogs 2-20kg
- AAS8348** Heated Smooth-Wall Breathing Circuit 16mm For Dogs 30-80kg
- AAS8617** Heat Controller Temperature Probe Outside Diameter 2.5mm for Exotics and Birds
- AAS8618** Heat Controller Temperature Probe Outside Diameter 3.6mm For Cats, Dogs and Rabbits
- AAS8615** Heated Circuit Connection Cable (Spare Part)
- AAS10104** Protective Cover for Breathing Circuits and ETCO<sub>2</sub> Sensor

## Darvall Express Monitor



Rugged monitor designed to automatically commence operation by simply pushing the power button and connecting two sensors. Comes complete with Nellcor SpO<sub>2</sub>, Suntech NIBP hose temperature probe and DOC-10 extension cable.

### Features:

- Nellcor™ pulse oximetry
- Darvall minimal dead space capnography
- Darvall body temperature probe
- Suntech veterinary non-invasive blood pressure (NIBP)
- Single one touch quick set button
- Default system set-up for cats and small dogs
- Darvall's innovative conforming NIBP cuffs covering seven sizes, for all small animals
- Easy to see colour-coded display
- Red – Heart rate and O<sub>2</sub>. Blue – blood pressure. Green – body temperature
- Long battery life

- AAS9624** Darvall Express Monitor
- AAS9969** Pole Mount Bracket for Darvall Express

### Replacement parts for Darvall Express:

- AAS9857** NIBP Hose 2.5m Long for Darvall Express
- AAS9204** Oesophageal/Rectal Temp Probe for Darvall Express
- AAS8811** Nellcor Extension Cable DOC-10 for Darvall Express
- AAS10016** 1GB Storage Card for IRIS use for Darvall Express
- AAS10104** Protective Cover for Breathing Circuits and ETCO<sub>2</sub> Sensor

## Darvall Capnograph



The Darvall Capnograph continuously measures the EtCO<sub>2</sub> and respiratory rate, and features EtCO<sub>2</sub> waveform Cardiac Oscillation artifact detection for correct respiratory rate determination. It is a reliable and accurate way of monitoring depth of anaesthesia. Only suitable for Darvall Express.

### Features:

- Rugged, low-cost sensor
- Fast, sensitive sensor, for better performance in small animals
- Mainstream capnography avoids waste gasses
- Ideal for low-flow low-emission environmentally friendly anaesthesia
- Waveform Cardiac Oscillation artifact detection for correct respiratory rate determination

- AAS9627** Mainstream ETCO<sub>2</sub> Sensor for Darvall Express
- AAS2120** Paediatric Mainstream Airway Adapter - (Purple)
- AAS2121** Adult Mainstream Airway Adapter - (Clear)

Sidestream is also available and only suitable for Darvall Express

- AAS9965** Sidestream ETCO<sub>2</sub> Sensor for Darvall Express
- AAS10112** Sampling Line for Sidestream CO<sub>2</sub>

## Darvall Veterinary Blood Pressure Cuffs



NIBP small animal cuffs are designed for accurate pressure detection in exotics, cats and all sizes of dog. The wide Velcro tabs provide secure conformation to the limb, with resilient but tactile silicon for reliable accurate signal transduction and validated pressure detection, including in conscious animals. Seven sizes for all small animals.

- AAS9890** Darvall NIBP Cuff Size 0. Limb Circumference 3.5cm - 6.5cm
- AAS9891** Darvall NIBP Cuff Size 1. Limb Circumference 5cm - 7.5cm
- AAS9892** Darvall NIBP Cuff Size 2. Limb Circumference 6cm - 8.5cm
- AAS9889** Darvall NIBP Cuff Size C. Limb Circumference 7cm - 10cm (Cat Size)
- AAS9893** Darvall NIBP Cuff Size 3. Limb Circumference 8.5cm - 11cm
- AAS9894** Darvall NIBP Cuff Size 4. Limb Circumference 10cm - 14cm
- AAS9896** Darvall NIBP Cuff Size 5. Limb Circumference 12cm - 16cm
- AAS9898** Darvall NIBP Cuff Size 8. Limb Circumference 14cm - 22cm
- AAS10042** Darvall NIBP Cuff Size 10. Limb Circumference 20cm - 29cm
- AAS10043** Darvall NIBP Cuff Size 13. Limb Circumference 27cm - 37cm
- AAS9895** Darvall NIBP Cuff Set. Sizes 0-5 and C (7 Cuffs)
- AAS10012** Darvall NIBP Vet-Cuff Range Circumference Measuring Strip

### Replacement parts for Darvall H100N and Darvall Express:

- AAS9897** NIBP Adapter Hose Bayonet to Luer for Darvall Cuffs
- AAS8062** Darvall O<sub>2</sub>-SAT Nellcor Vet Sensor for H100N and Darvall Express Monitor
- AAS8208** Darvall Nellcor Sensor Clip for Small Animal

## Darvall HI00N Pulse Oximeter and Temperature Monitor



Convenient and reliable handheld pulse oximetry and temperature monitor, embedded with world leading Nellcor OxiMax™ pulse oximetry technology.

### Features:

- Nellcor OxiMax™ pulse detection
- Temperature channel for rapid check
- LCD display with backlight control
- Automatic power-off function for power saving
- Comes complete with SpO<sub>2</sub> sensor, temperature sensor and protective rubber boot.

**AAS5391** Darvall HI00N Pulse Oximeter and Temperature Monitor

The monitor can be used with either 4 x AA batteries for up to 48 hours of work or a rechargeable battery for up to 30 hours of work.

**AAS8049** Charger Dock and 1 x Ni-MH Battery for HI00N Pulse Oximeter

**AAS8175** Ni-MH Battery for HI00N Pulse Oximeter

Replacement parts for Darvall HI00N Pulse Oximeter and Temperature Monitor

**AAS7870** Rectal/Oral Temperature Probe for HI00N Pulse Oximeter



## Loan Kits

For a nominal fee, we have a range of **specialist loan kits** available to complement your own fleet. With next working day availability, the service offers flexibility as procedures are booked with your clients.

To find out more, scan the QR code below.



# Rehabilitation



To view the Rehabilitation section of our website, please scan the QR code.



## Dressing and Support

### Thera-Paw



Thera-Paw acts as a reusable bandage with a protective base.

Key Thera-Paw Features:

- Ultra-cushioned sole alleviates pain, reducing lameness and promoting more even weight distribution
- Use of perforated top-sole material and cut-out design allow the paw to breathe and keeps the injured site free from moisture build-up
- Rubberized, non-skid base and toe-cap are waterproof, protect the site from further injury, and provide better traction
- Vertical closure design runs parallel to the carpal/tarsal bones, dispersing pressure over a wide area
- Thera-Paw is easily cleaned by rinsing it under warm water. Mild detergent may be used. It air dries in under 1 hour, and is ready for immediate reapplication
- Front opening and closing mechanism makes it easy to slip Thera-paw into place
- Outer safety strap provides additional security, to ensure that Thera-paw stays on even the most active dogs
- Dual closing mechanism reduces the risk that a dog can remove the garment

<b>200002</b>	Thera-Paw Small (T/B)
<b>200003</b>	Thera-Paw Small/ Medium (T/C)
<b>200003#2</b>	Thera-Paw Small/ Medium#2 (T/D)
<b>200004</b>	Thera-Paw Medium (T/E)
<b>200005</b>	Thera-Paw Medium/ Large (T/F)
<b>200006</b>	Thera-Paw Large (T/G)
<b>2000SET</b>	Thera-Paw Set of 6 (As above)

## Medipaw<sup>®</sup> Protective Boot



A professional waterproof but breathable cover for dressings and casts. Available in colour coded sizes, they have a durable non-skid base, and elasticised straps with Velcro closures as well as an upper cord lock.

### Hard Sole Medipaw

<b>200015</b>	Medipaw Boot Hard Sole Extra Small Wide (XSW) - Orange
<b>200020</b>	Medipaw Boot Hard Sole Extra Small - Yellow
<b>200031</b>	Medipaw Boot Hard Sole Extra Small #2 - Pink
<b>200025</b>	Medipaw Boot Hard Sole Small - Blue
<b>200030</b>	Medipaw Boot Hard Sole Medium - Red
<b>200035</b>	Medipaw Boot Hard Sole Large - Green
<b>200037</b>	Medipaw Boot Hard Sole Large Wide - Grey
<b>200040</b>	Medipaw Boot Hard Sole Extra Large - Purple
<b>200091SET</b>	Medipaw Boot Hard Sole Set of 5 - XS, S, M, L, XSW

### Soft Sole Medipaw

<b>200097</b>	Medipaw Boot Soft Sole Extra Small Wide (XSW)- Orange
<b>200093</b>	Medipaw Boot Soft Sole Extra Small - Yellow
<b>200092</b>	Medipaw Boot Soft Sole Extra Small #2 - Pink
<b>200094</b>	Medipaw Boot Soft Sole Small - Blue
<b>200095</b>	Medipaw Boot Soft Sole Medium - Red
<b>200096</b>	Medipaw Boot Soft Sole Large - Green
<b>200099</b>	Medipaw Boot Soft Sole Large Wide - Grey
<b>200098</b>	Medipaw Boot Soft Sole Extra Large - Purple
<b>200090SET</b>	Medipaw Boot Soft Sole Set of 5 - XS, S, M, L, XSW

## Medipaw® Slim Boot



Superior open-wound healing for dogs and cats. Medipaw® Slim — the protective veterinary boot with a soft, antimicrobial bamboo and silver lining.

Indicated for dog and cat open-wound treatment:

- Burns
- Degloving
- Excessive licking and irritation
- Hot spots
- Lick granulomas
- Punctures

Medipaw Slim Boot Features:

- Machine washable/hang dry
- Durable, non-skid, rubber sole
- Upper drawstring closure
- Adjustable elastic/secure Velcro® straps
- Reflective strap
- Waterproof/breathable nylon shell
- Scuff guard

<b>MDS-XS</b>	Medipaw Slim Boot Extra Small - Yellow
<b>MDS-S</b>	Medipaw Slim Boot Small - Blue
<b>MDS-M</b>	Medipaw Slim Boot Medium - Red
<b>MDS-L</b>	Medipaw Slim Boot Large - Green
<b>MDS-XL</b>	Medipaw Slim Boot Extra Large - Purple
<b>MDS-STR</b>	Medipaw Slim Boot Starter Pack Set of 3 - S, M, L

## Medipaw Protective Suit For Dogs and Cats



From the manufacturers of the popular Medipaw protective boot comes a new addition to the patient protection range.

The Medipaw suit is available in a range of sizes to fit dogs and cats. The suit is a 2 piece design, which makes fitting and removing easier. The two parts have an easy Velcro closure. The top gives full coverage of the thorax.

Indications for use are many. This suit can be used as an alternative to an Elizabethan collar to discourage post-operative interference with wounds, to reduce the incidence of tick infestation, to protect drain tube sites, during the treatment of skin conditions etc. An alternative use for the Medipaw Protective Suit is in the management of anxiety in dogs.

Features include a wide opening for litter tray use, a port opening, and internal pockets in both top and bottom parts which can take ice packs to relieve swelling or pads for absorption.

Machine washable, the suit is made of 95% cotton, 5% Lycra.

Colour coded stitching and logo indicate size, for easy recognition and re-ordering.



<b>SUITPSS-XXS</b>	Two Piece Suit XXS	Pink
<b>SUITPSS-XS</b>	Two Piece Suit XS	Yellow
<b>SUITPSS-S</b>	Two Piece Suit S	Blue
<b>SUITPSS-S+</b>	Two Piece Suit S+	Orange
<b>SUITPSS-M</b>	Two Piece Suit M	Red
<b>SUITPSS-XL</b>	Two Piece Suit XL	Purple
<b>SUITPSS-S-CAT</b>	Two Piece Suit S Cat	Blue
<b>SUITPSS-M-CAT</b>	Two Piece Suit M Cat	Red
<b>SUITPSS-L-CAT</b>	Two Piece Suit L Cat	Green

## Carp Flex Range

Carp Flex are a range of supports designed to stabilise the carpus.

### Carp Flex Sports Wrap Light Support

<b>200011L</b>	Carp Flex Sports Wrap XS Left Green
<b>200011R</b>	Carp Flex Sports Wrap Green XS Right
<b>200012L</b>	Carp Flex Sports Wrap S Left Red
<b>200012R</b>	Carp Flex Sports Wrap Red S Right
<b>200013L</b>	Carp Flex Sports Wrap M Left Blue
<b>200013R</b>	Carp Flex Sports Wrap Blue M Right
<b>200014L</b>	Carp Flex Sports Wrap L Left Back
<b>200014R</b>	Carp Flex Sports Wrap L Black Right

### Carp Flex X Moderate Support

<b>200070L</b>	Carp Flex X Wrap XS Left
<b>200070R</b>	Carp Flex X Wrap XS Right
<b>200071L</b>	Carp Flex X Wrap S Left
<b>200071R</b>	Carp Flex X Wrap S Right
<b>200072L</b>	Carp Flex X Wrap M Left
<b>200072R</b>	Carp Flex X Wrap M Right
<b>200073L</b>	Carp Flex X Wrap L Left
<b>200073R</b>	Carp Flex X Wrap L Right
<b>200074L</b>	Carp Flex X Wrap XL Left
<b>200074R</b>	Carp Flex X Wrap XL Right

### Carp Flex Splint Kit Strong Support

<b>200060L</b>	Carp Flex Splint Kit XS Left
<b>200060R</b>	Carp Flex Splint Kit XS Right
<b>200061L</b>	Carp Flex Splint Kit S Left
<b>200061R</b>	Carp Flex Splint Kit S Right
<b>200062L</b>	Carp Flex Splint Kit M Left
<b>200062R</b>	Carp Flex Splint Kit M Right
<b>200063L</b>	Carp Flex Splint Kit L Left
<b>200063R</b>	Carp Flex Splint Kit L Right
<b>200064L</b>	Carp Flex Splint Kit Extra Large - Left
<b>200064R</b>	Carp Flex Splint Kit Extra Large - Right

### Forelimb Dorsi-Flex Assist

Forelimb Dorsi-Flex Assist is used to aid the normal placement of the forelimb and support the carpus. Limited stock available.

<b>200027R</b>	Forelimb Dorsi Flex Assist T/E M Right
<b>200027L</b>	Forelimb Dorsi Flex Assist T/E M Left
<b>200028R</b>	Forelimb Dorsi Flex Assist T/F M/L Right
<b>200028L</b>	Forelimb Dorsi Flex Assist T/E M/L Left
<b>200029R</b>	Forelimb Dorsi Flex Assist T/G L Right
<b>200029L</b>	Forelimb Dorsi Flex Assist T/G L Left

## Tarso-Flex X

Tarso-Flex X offers moderate tarsal support.

<b>200100XSL</b>	Tarso Flex X - XS Left
<b>200100XSR</b>	Tarso Flex X - XS Right
<b>200100SR</b>	Tarso Flex X - Small Right
<b>200100SL</b>	Tarso Flex X - Small Left
<b>200100MR</b>	Tarso Flex X - Medium Right
<b>200100ML</b>	Tarso Flex X - Medium Left
<b>200100LR</b>	Tarso Flex X - Large Right
<b>200100LL</b>	Tarso Flex X - Large Left
<b>200100XLL</b>	Tarso Flex X - XL Left
<b>200100XLR</b>	Tarso Flex X - XL Right

## Dorsi-Flex Assist

Dorsi-Flex Assist is used to aid the normal placement of the hind limb.

<b>200018</b>	Dorsi Flex Assist Therapaw Tibial Wrap and Velcro TB Tiny
<b>200019</b>	Dorsi Flex Assist Therapaw Tibial Wrap and Velcro TC XXS
<b>200021</b>	Dorsi Flex Assist Therapaw Tibial Wrap and Velcro TD XS
<b>200022</b>	Dorsi Flex Assist Therapaw Tibial Wrap and Velcro TE S
<b>200023</b>	Dorsi Flex Assist Therapaw Tibial Wrap and Velcro TF M
<b>200024</b>	Dorsi Flex Assist Therapaw Tibial Wrap and Velcro TG L

## Padded Splints

Made from green foam lined plastic.

<b>090120</b>	Splints Padded Small 210mm
<b>090121</b>	Splints Padded Medium 310mm
<b>090122</b>	Splints Padded Large 410mm

## Thermoplastic Splinting

The white sheet of Thermoplastic splint is heated in hot water and moulded to a specific custom shape for the patient.



<b>940A</b>	Marq Easy Thermoplastic Splinting Sheet 100x220mm
<b>940B</b>	Marq Easy Thermoplastic Splinting Sheet 152x300mm
<b>940C</b>	Marq Easy Thermoplastic Splinting Sheet 300x600mm
<b>940V</b>	Velcro Strap Hook For Thermoplastic Splints
<b>940X</b>	Compact Blue Foam Sheet For Thermoplastic Splints 400x600mm
<b>940KIT</b>	Thermoplastic Splinting Starter Kit Contains 940A, 940B, 940X & 940V

# Plate Profiles

To access the digital plate profiles featured in this chapter, please email [info@vetinst.com](mailto:info@vetinst.com)



**1.5mm Compression Plates**

- CI51674
- CI51465
- CI51256
- CI51152
- CI51047
- CI50943
- CI50838
- CI50734
- CI50629
- CI50525
- CI50420

**2.0mm Mini Plates**

- MP20317
- MP20423
- MP20529
- MP20635
- MP20741

**2.0mm Compression**

- CP201892
- CP201682
- CP201472
- CP201262
- CP201052
- CP20842
- CP20737
- CP20632
- CP20527
- CP20422

**2.0mm Round Hole Plates**

- PR200843
- PR200840
- PR200738
- PR200633
- PR200630
- PR200528
- PR200525
- PR200423
- PR200420
- PR200213

**2.0mm Biological Healing Plates**

- BHP2008080
- BHP2008075
- BHP2008070
- BHP2008065
- BHP2007060

**2.0mm ASYM® Plates**

- ASYM20030437
- ASYM20030542
- ASYM20030647
- ASYM20030752
- ASYM20040652
- ASYM20030857
- ASYM20040757
- ASYM20040862
- ASYM20031067
- ASYM20031172
- ASYM20041072



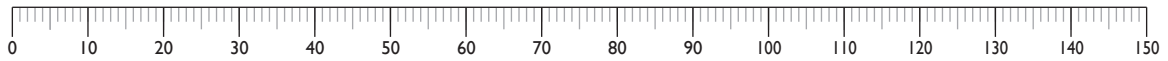

### 2.4mm Compression Plates

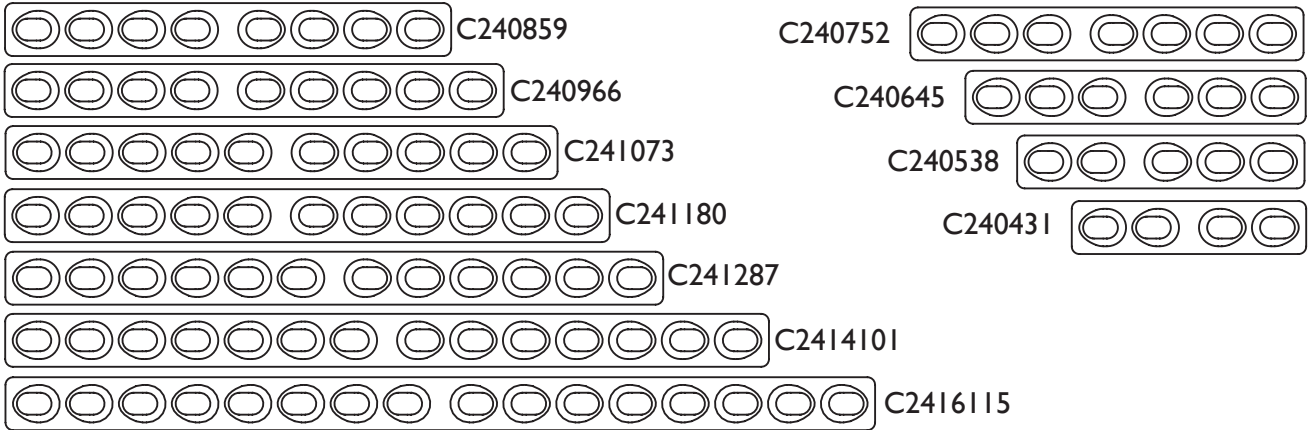

### 2.4mm ASYM® Plates

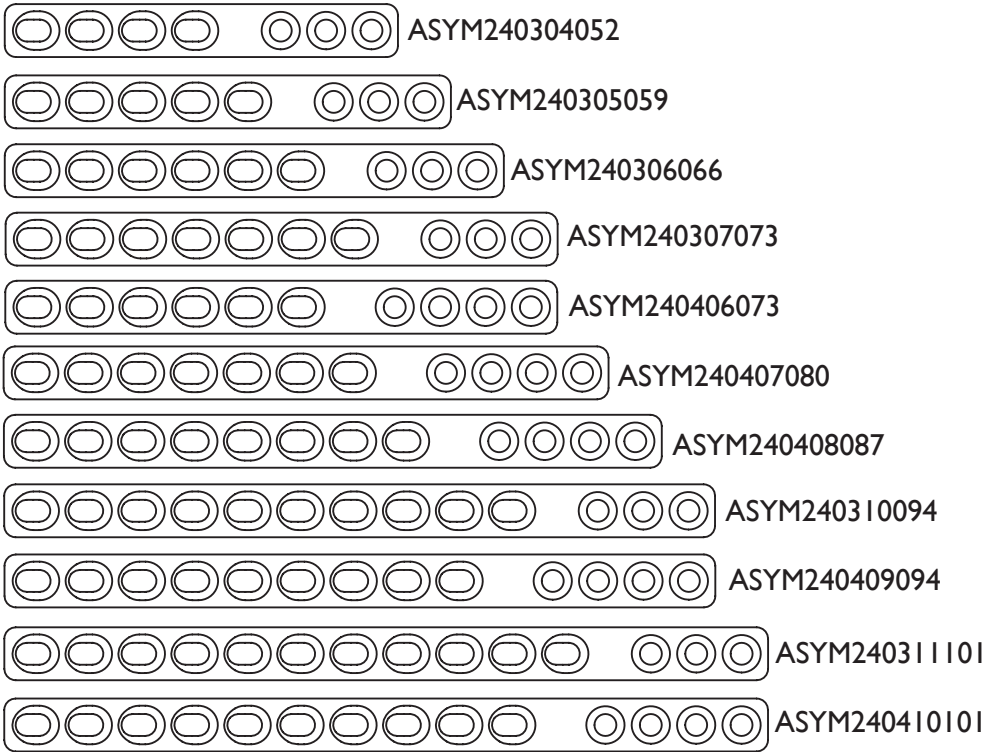

### 2.4mm Limited Contact Compression Plates

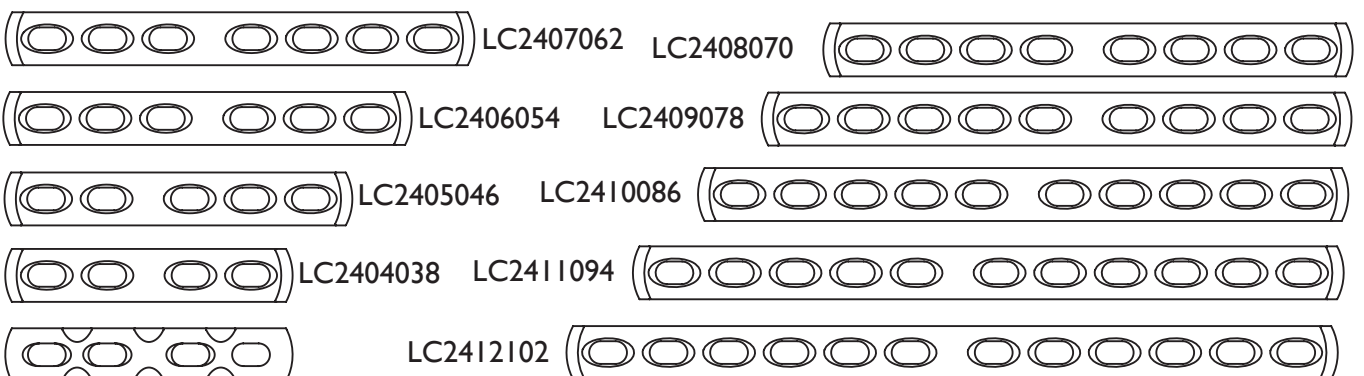

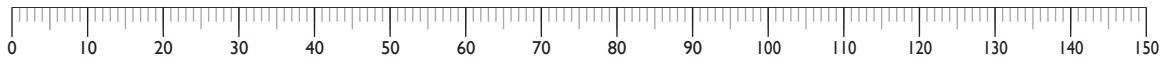

### 2.7mm Compression Plates

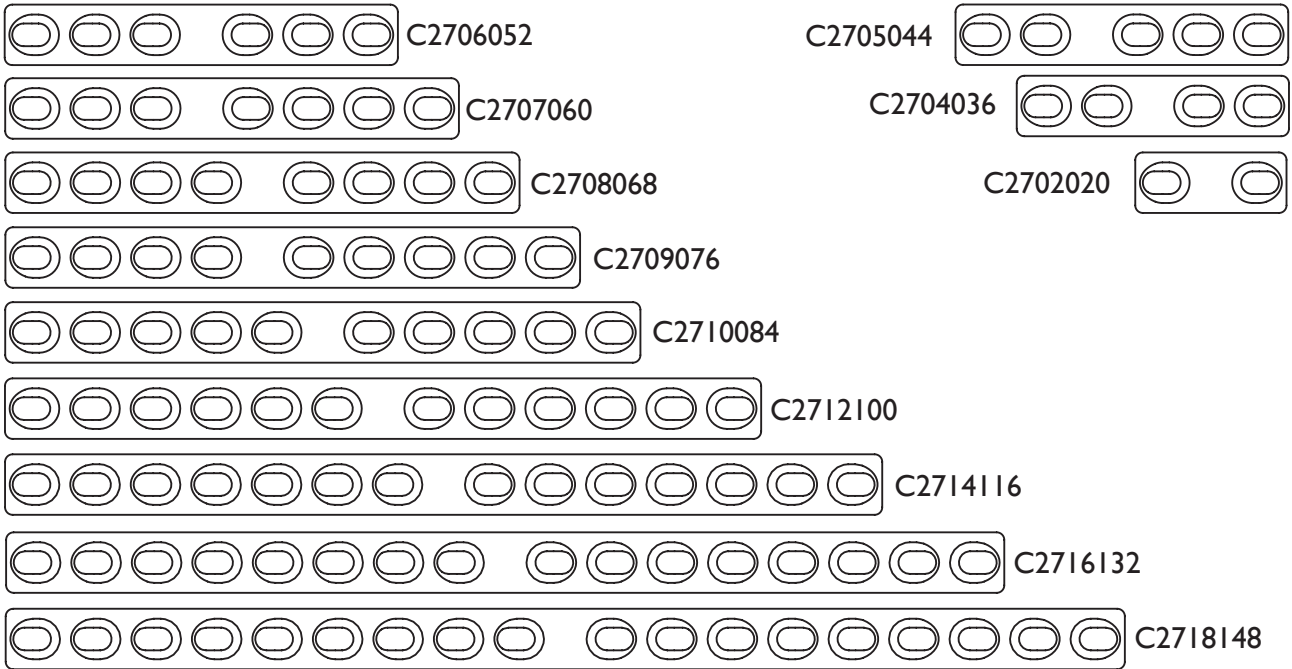

### 2.7mm ASYM<sup>®</sup> Plates

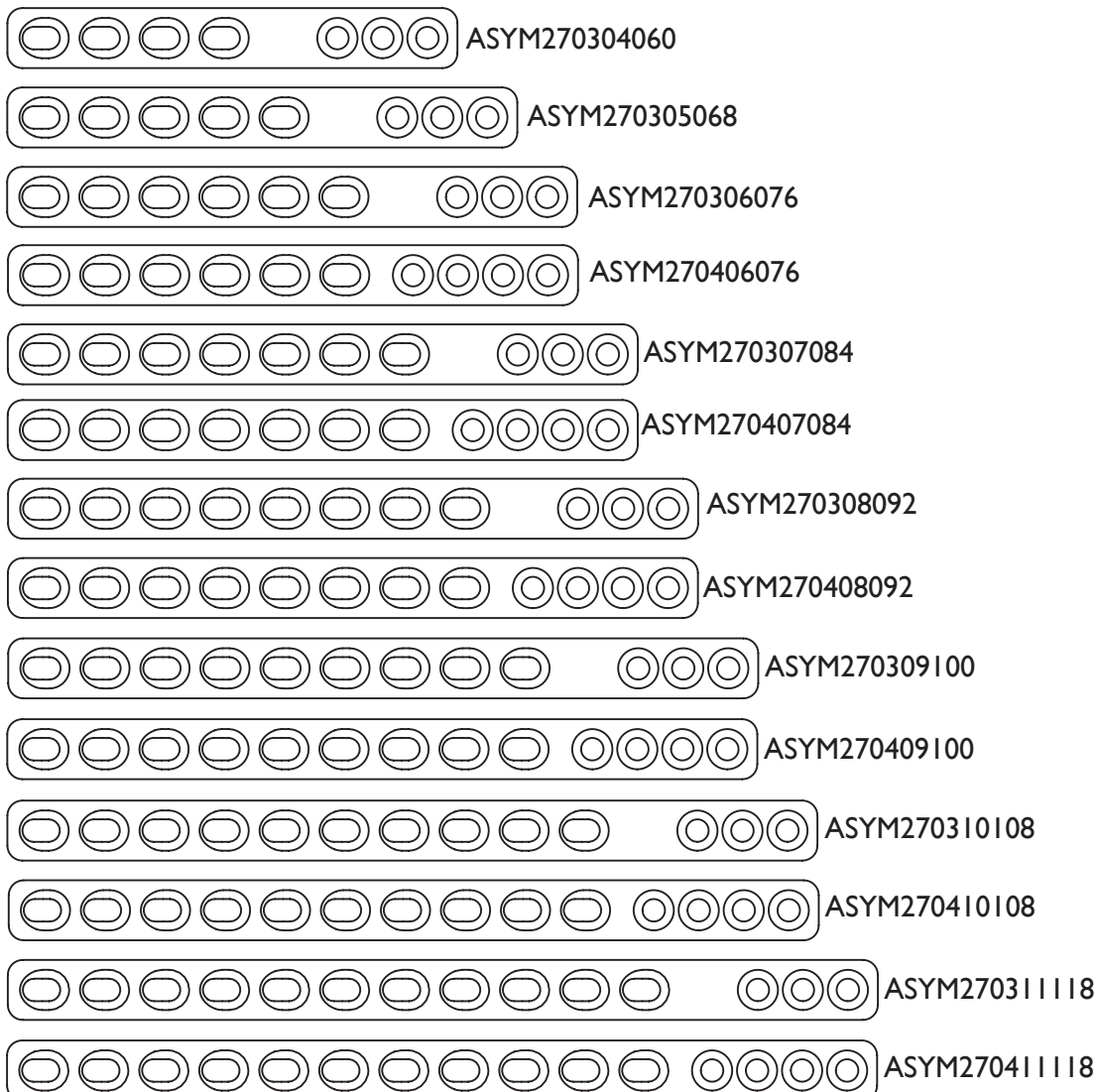

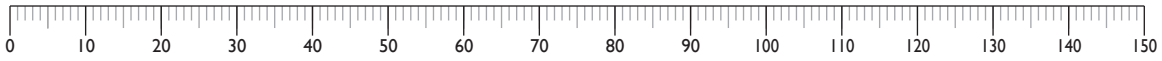

### 2.7mm Round Hole Plates

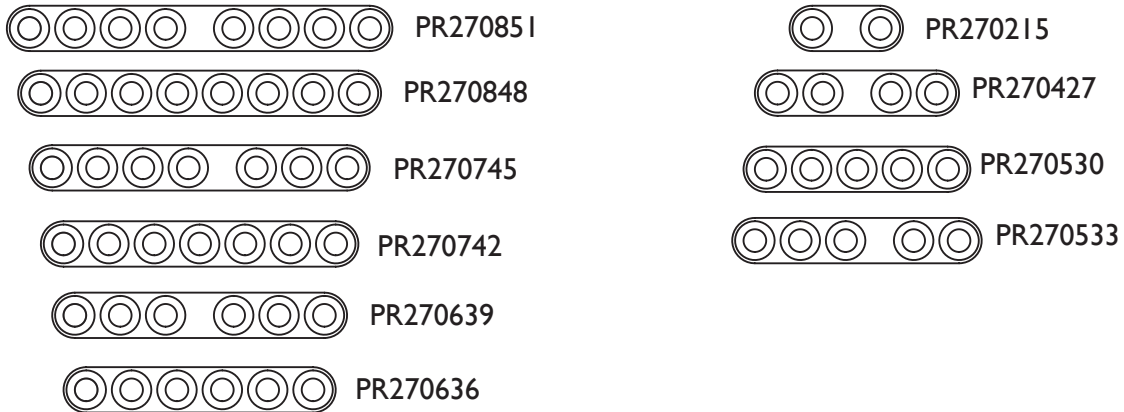

### 2.7mm Heavy Duty Round Hole Plates

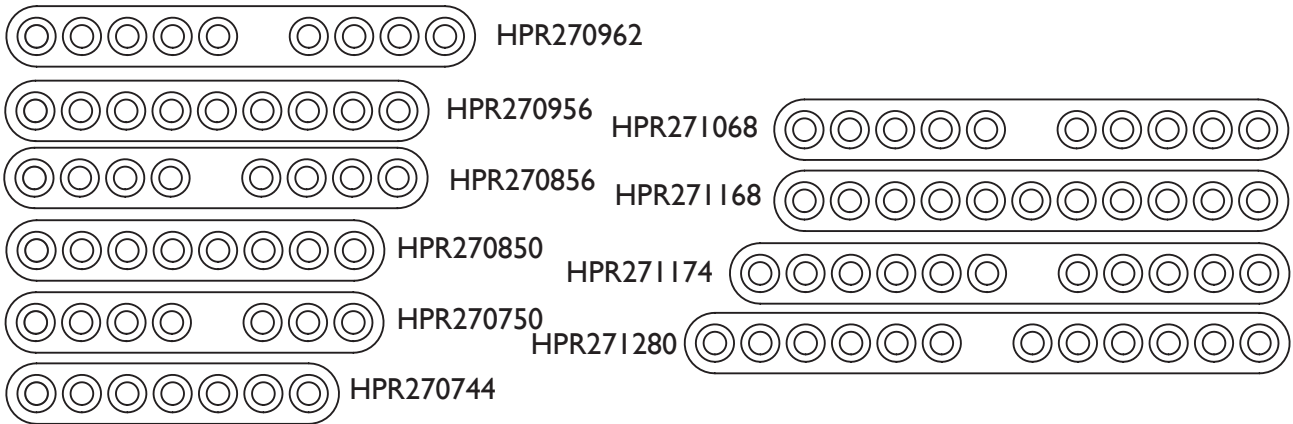

### 2.7mm Biological Healing Plates

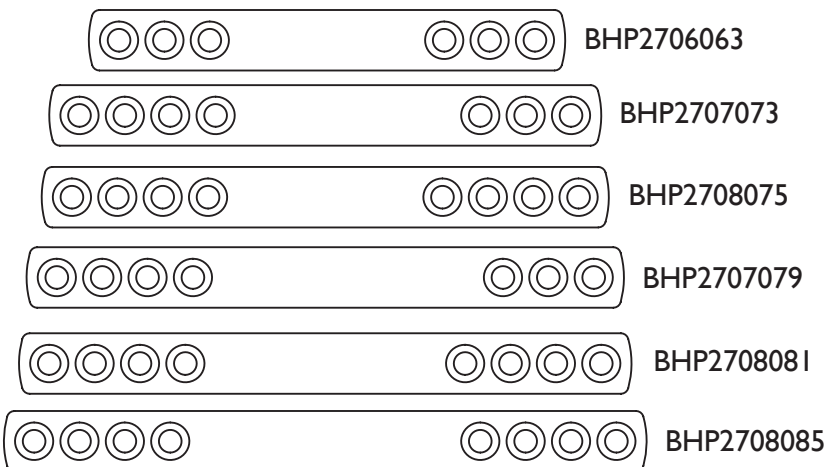

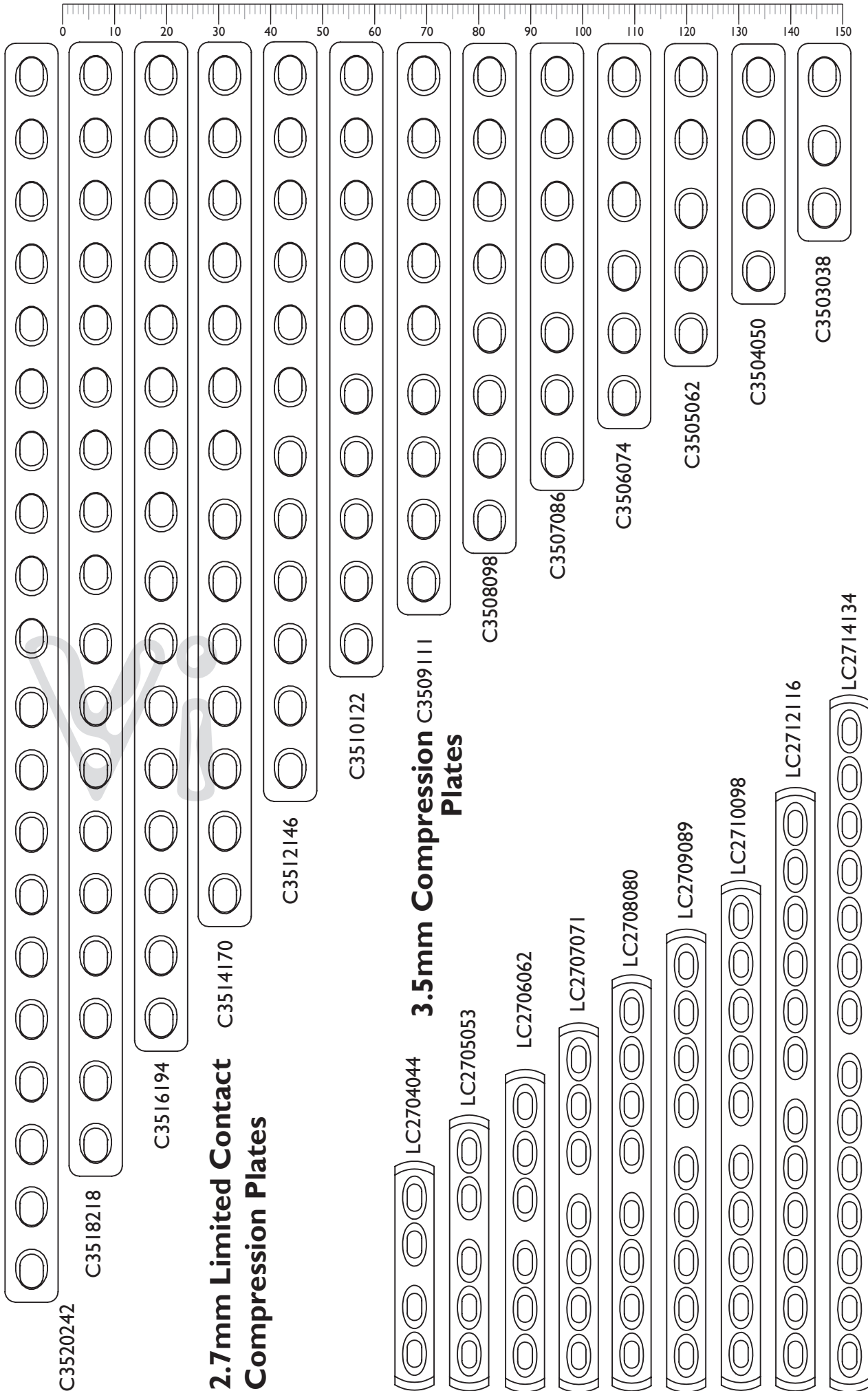

**2.7mm Limited Contact Compression Plates**

**3.5mm Compression Plates**

PLEASE NOTE THAT PLATE PROFILES ARE ACTUAL SIZE YOU WILL NEED TO COMPENSATE FOR X-RAY MAGNIFICATION • PROFILES FOR GUIDANCE ONLY PLATES MAY BE AMENDED AT ANY TIME

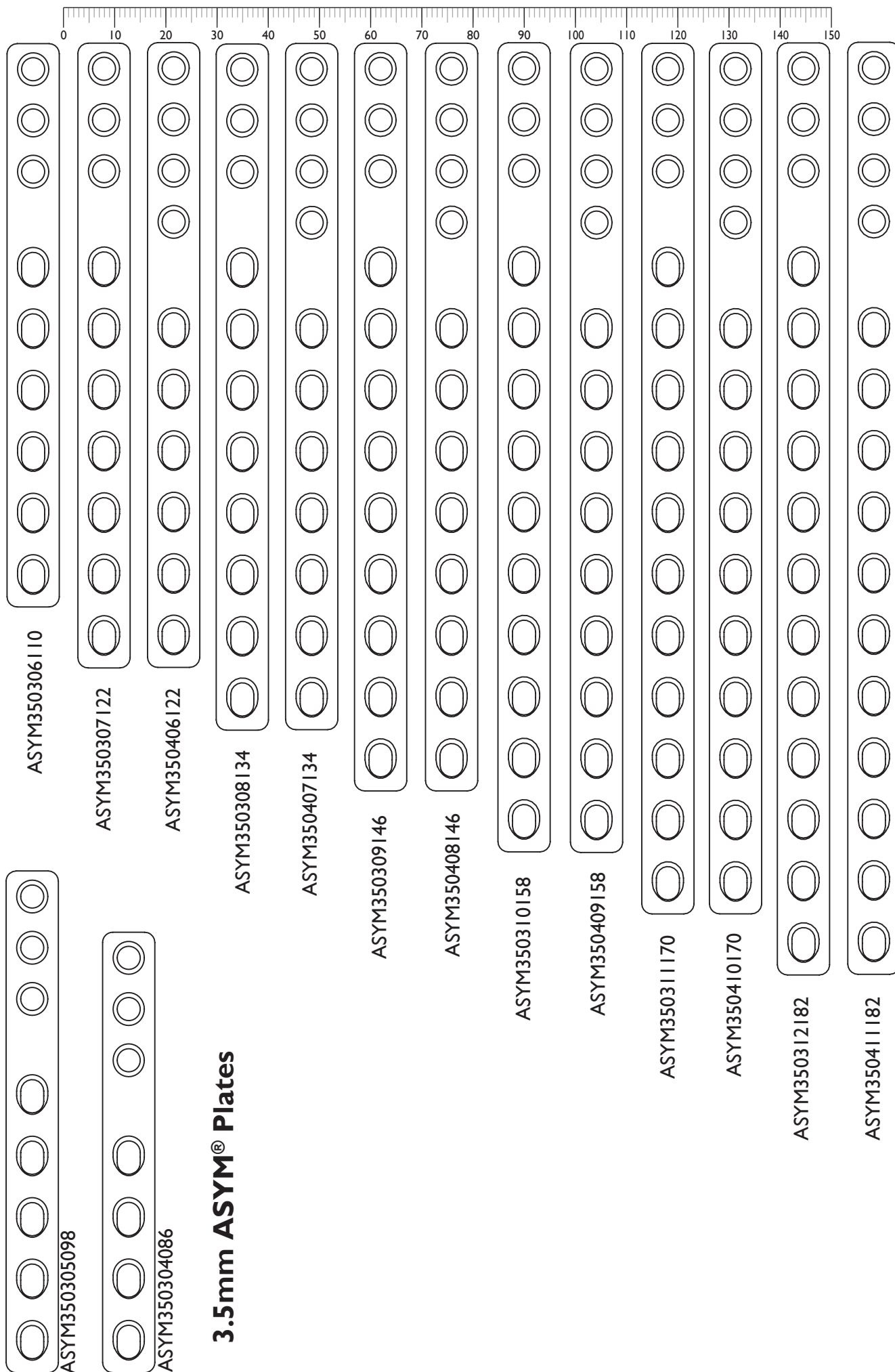

PLEASE NOTE THAT PLATE PROFILES ARE ACTUAL SIZE YOU WILL NEED TO COMPENSATE FOR X-RAY MAGNIFICATION • PROFILES FOR GUIDANCE ONLY PLATES MAY BE AMENDED AT ANY TIME

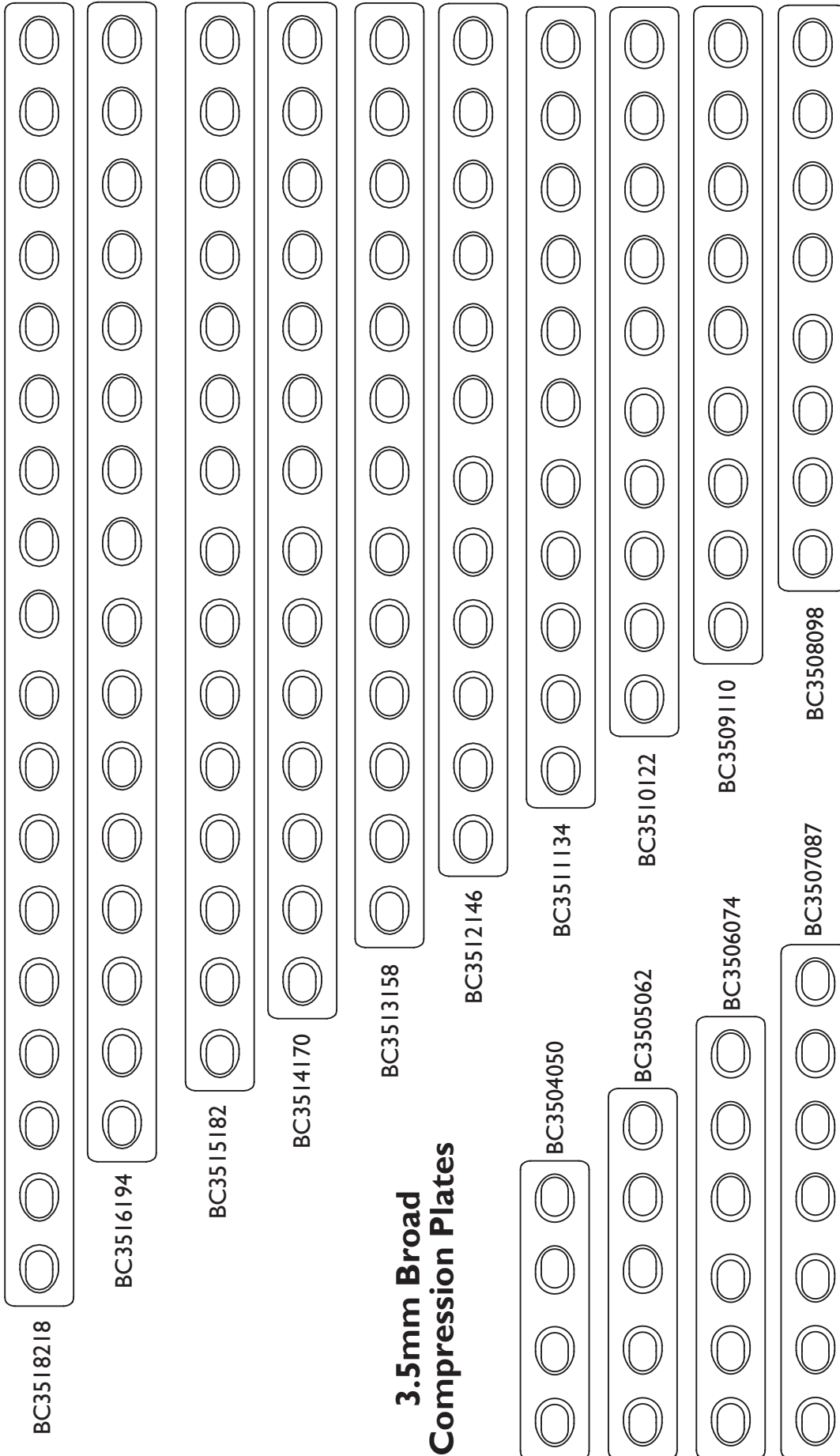
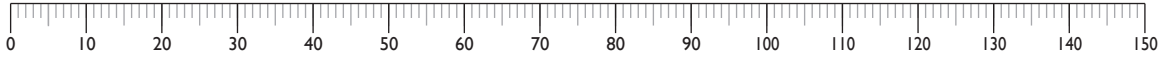

**3.5mm Broad  
Compression Plates**

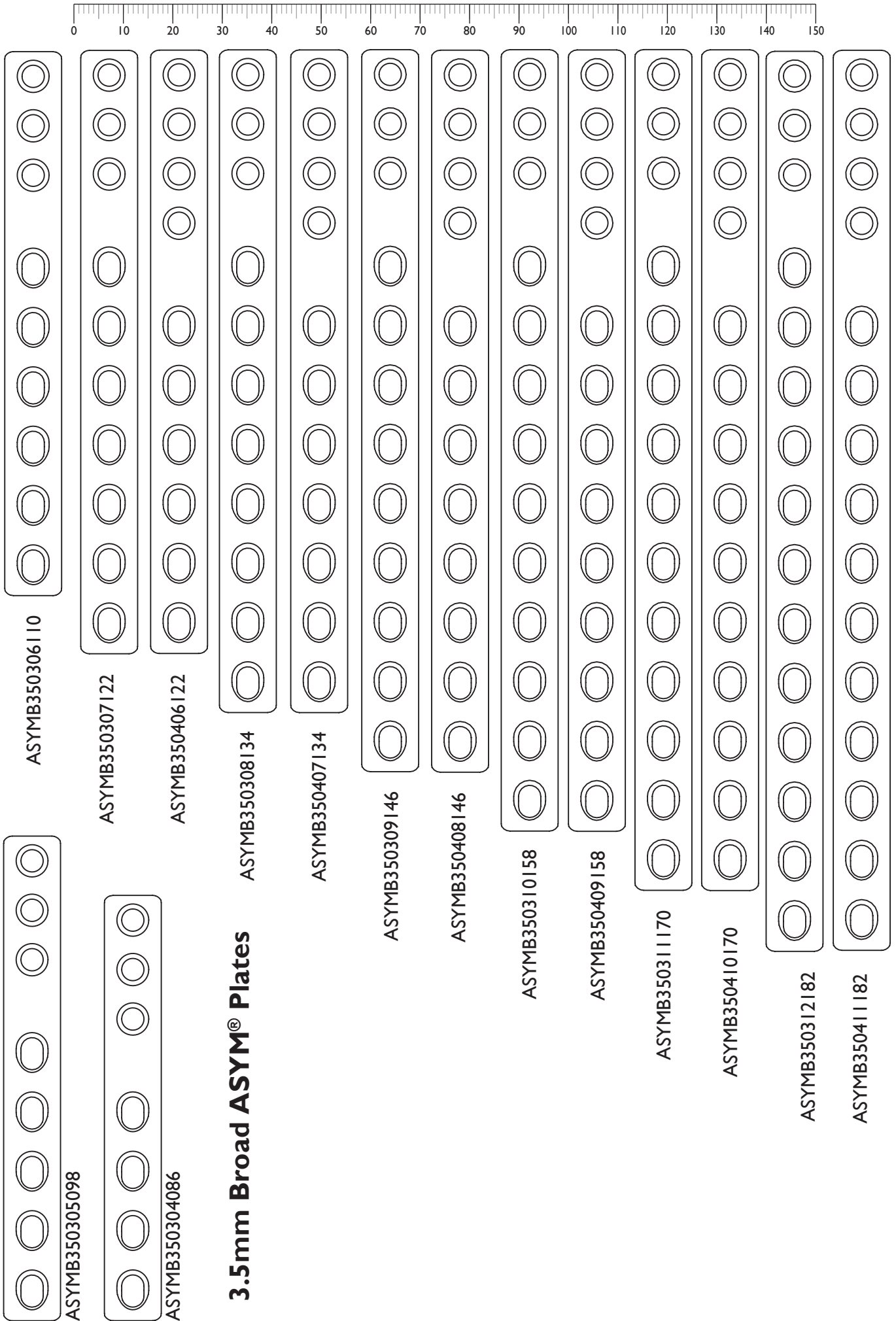

PLEASE NOTE THAT PLATE PROFILES ARE ACTUAL SIZE YOU WILL NEED TO COMPENSATE FOR X-RAY MAGNIFICATION • PROFILES FOR GUIDANCE ONLY PLATES MAY BE AMENDED AT ANY TIME

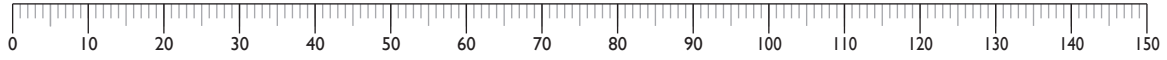

### 3.5mm Round Hole Plates

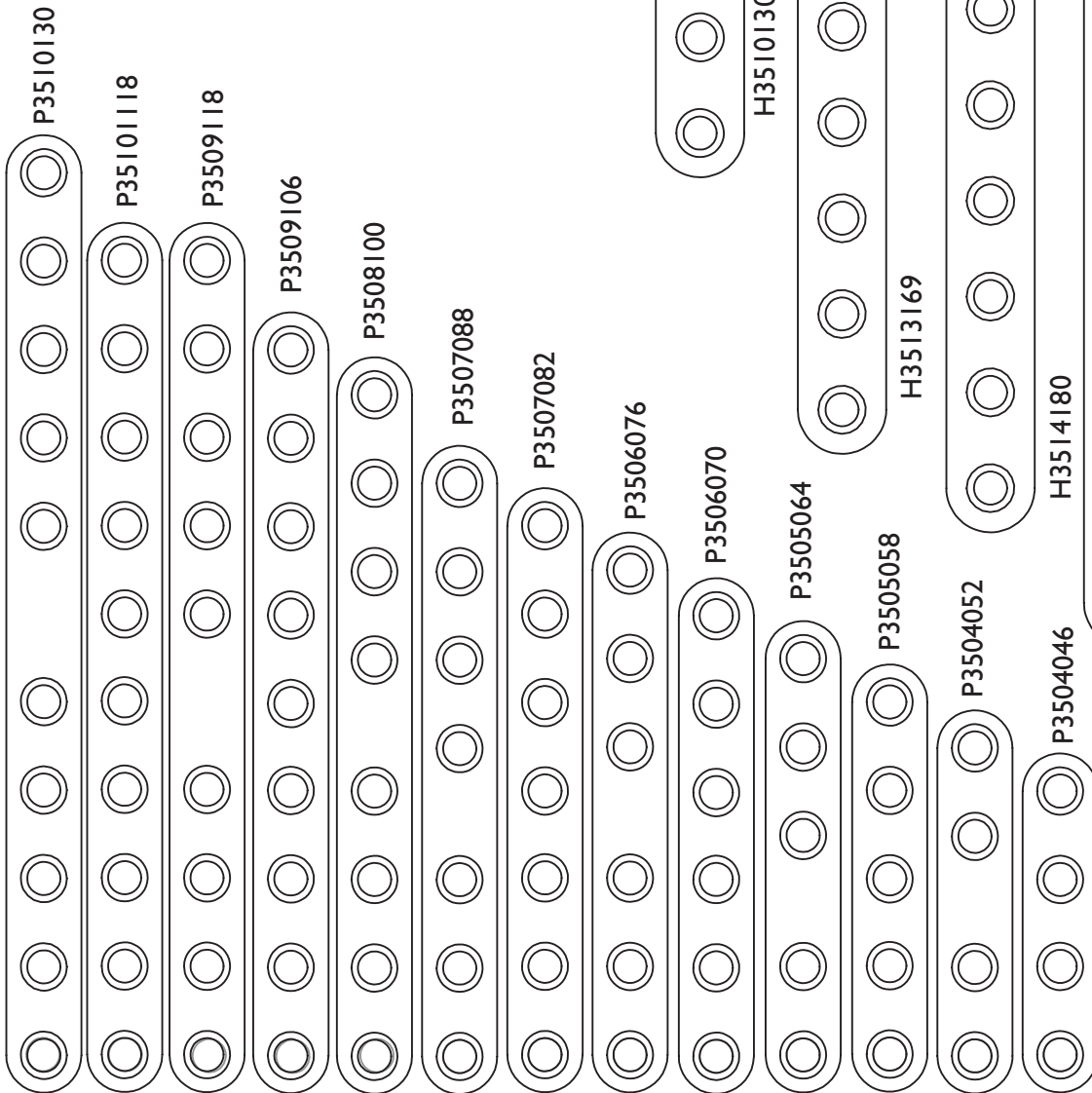

### 3.5mm Heavy Duty Round Hole Plates

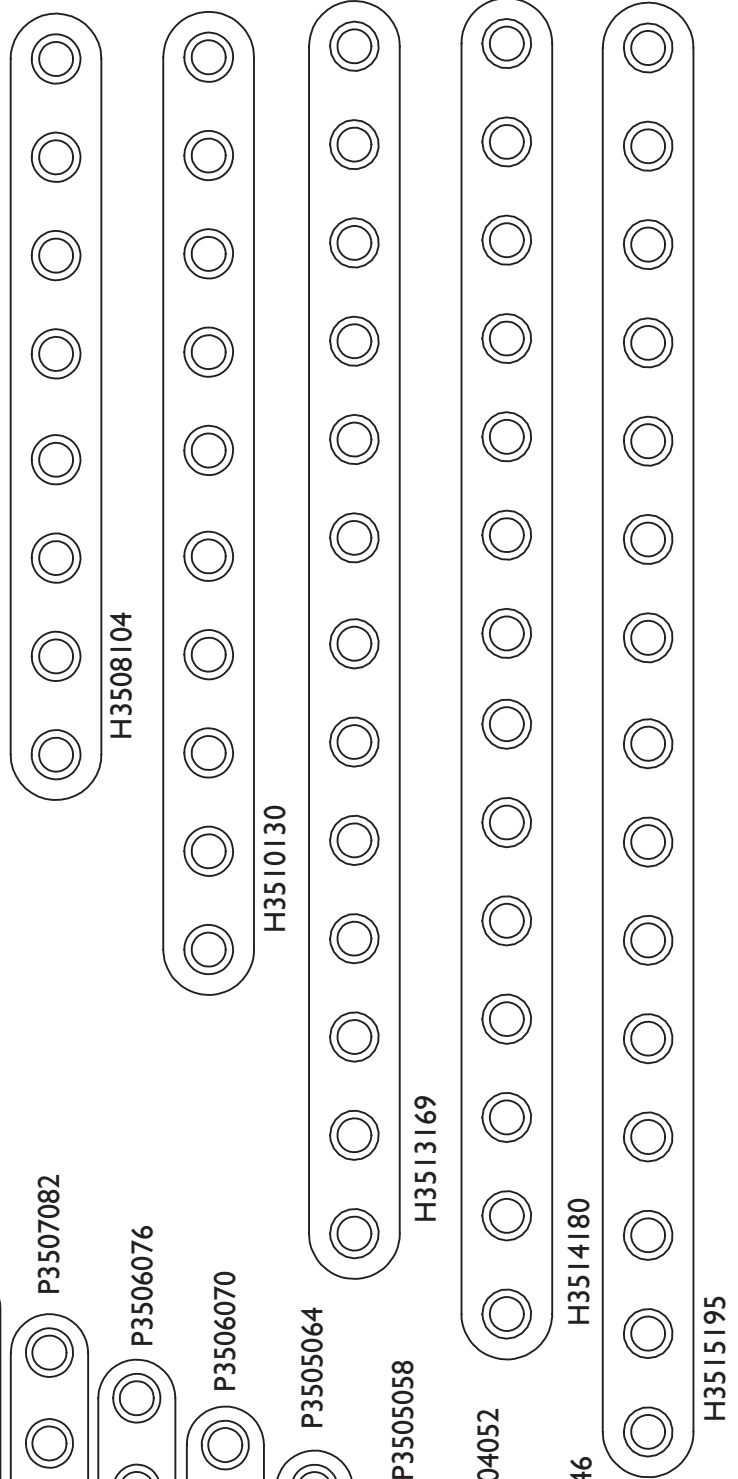



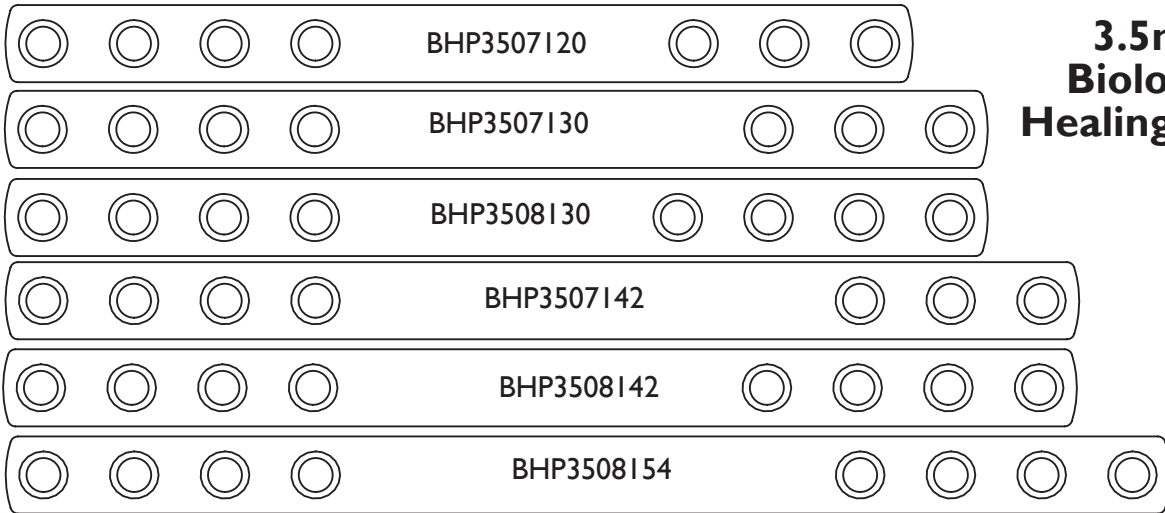

**3.5mm  
Biological  
Healing Plates**

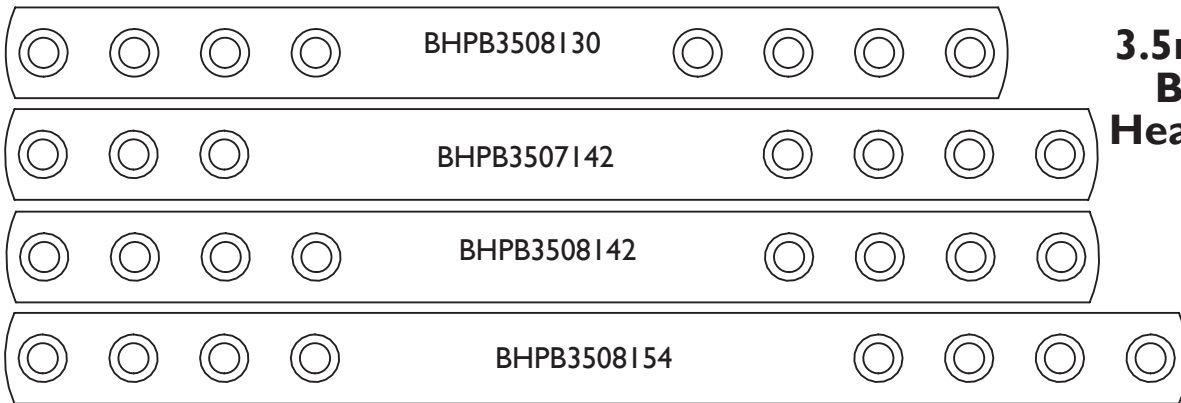

**3.5mm Broad  
Biological  
Healing Plates**

3.5mm LC plates also available in 16 hole.  
3.5mm broad LC plates are available in 7, 8,  
9 & 12 hole with the same hole spacing.

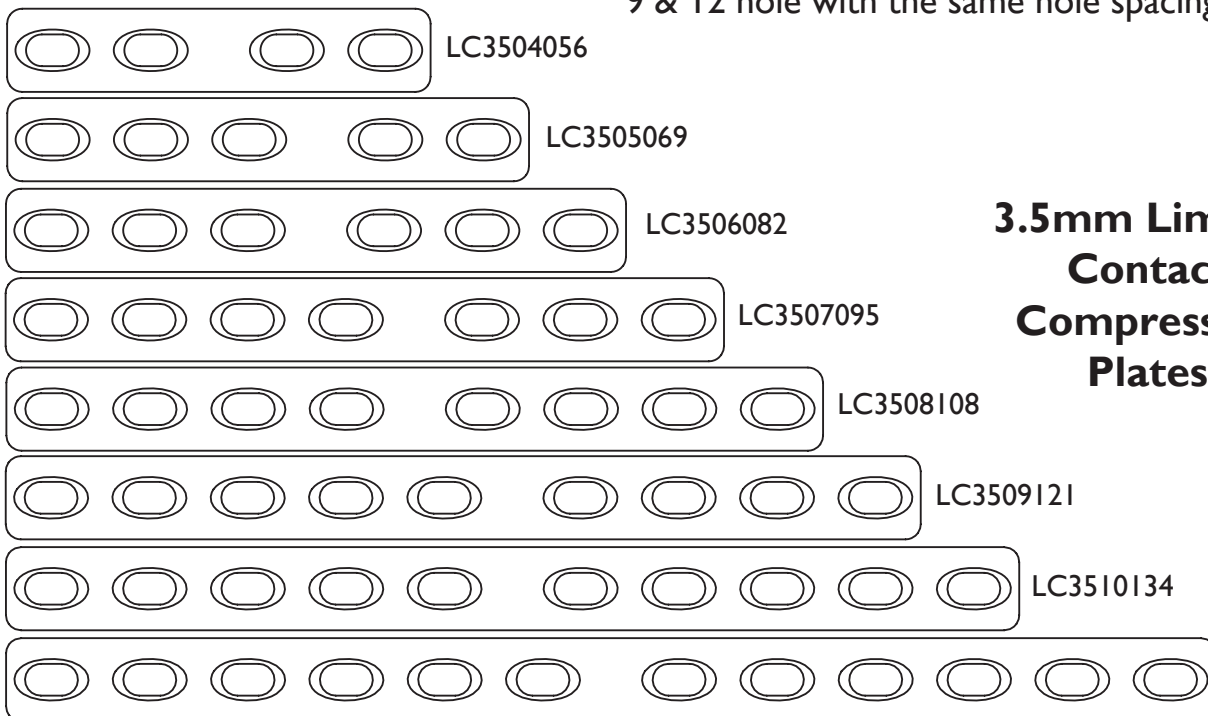

**3.5mm Limited  
Contact  
Compression  
Plates**

LC3512160

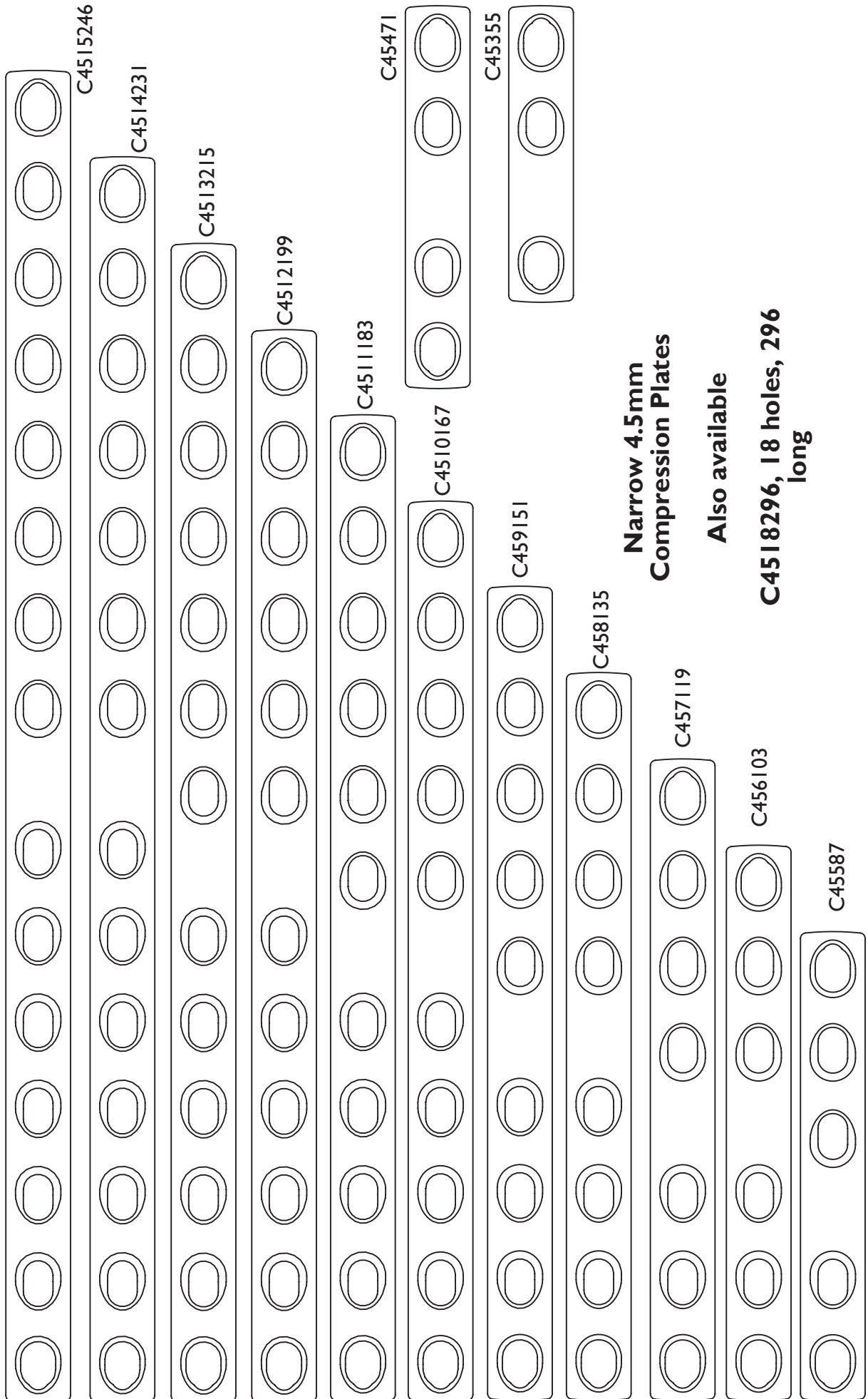
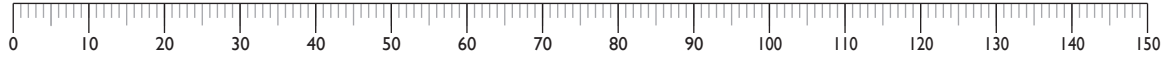

**Narrow 4.5mm  
Compression Plates**

**Also available**

**C4518296, 18 holes, 296  
long**

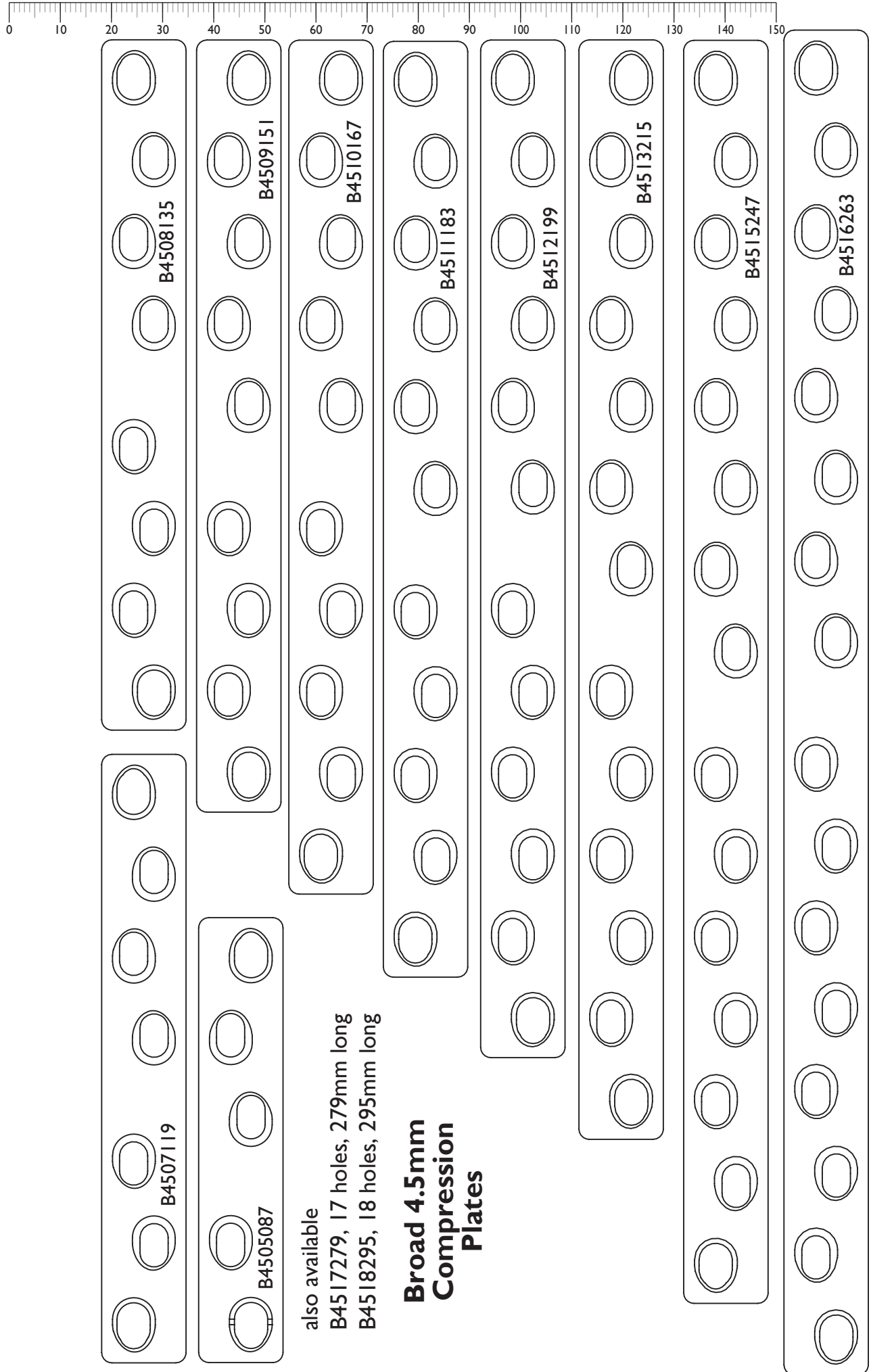

also available  
B4517279, 17 holes, 279mm long  
B4518295, 18 holes, 295mm long

### Broad 4.5mm Compression Plates

PLEASE NOTE THAT PLATE PROFILES ARE ACTUAL SIZE YOU WILL NEED TO COMPENSATE FOR X-RAY MAGNIFICATION • PROFILES FOR GUIDANCE ONLY PLATES MAY BE AMENDED AT ANY TIME

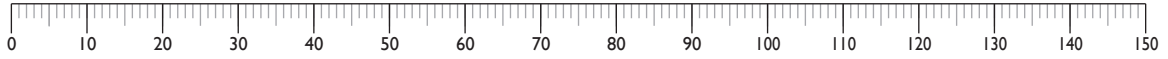

### 4.5mm Biological Healing Plates

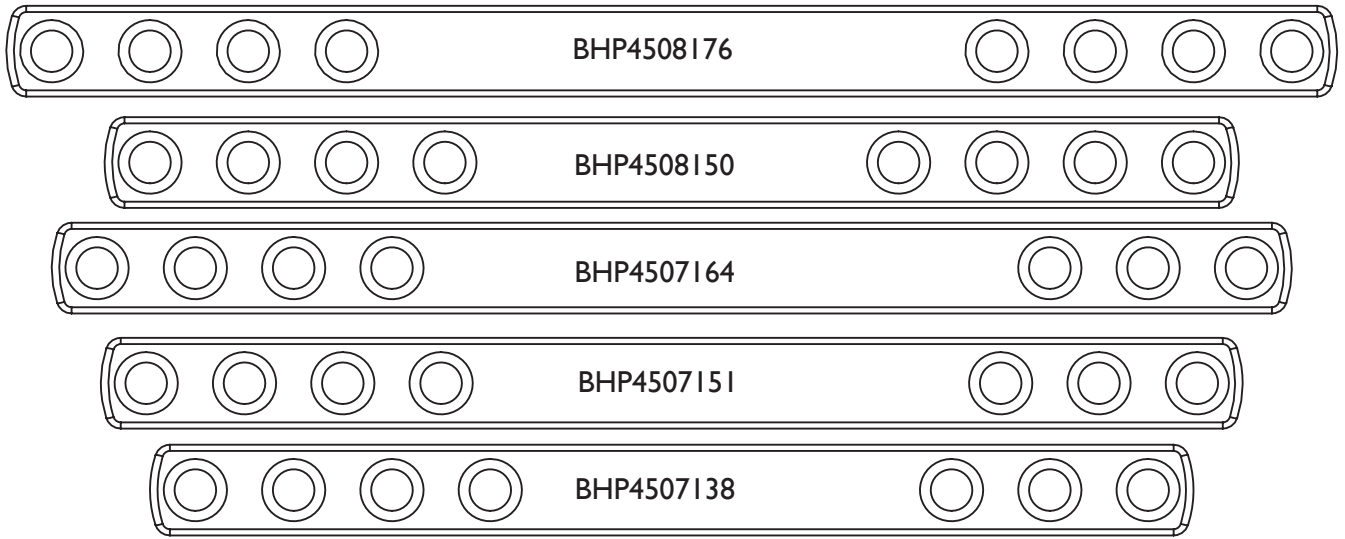

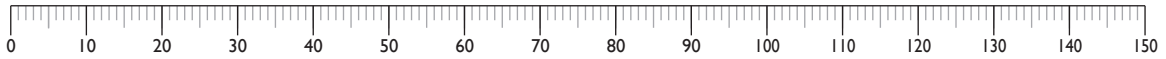

### 1.5mm T-Plates

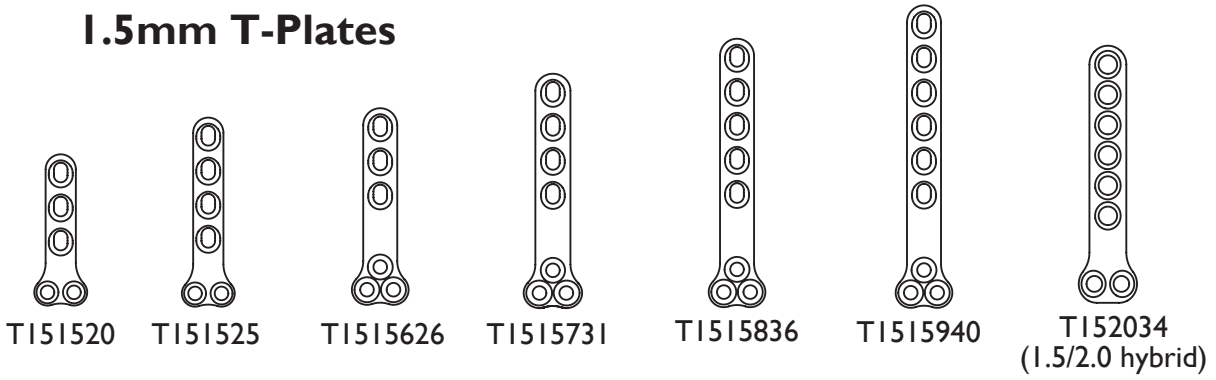

### 2.0mm T-Plates

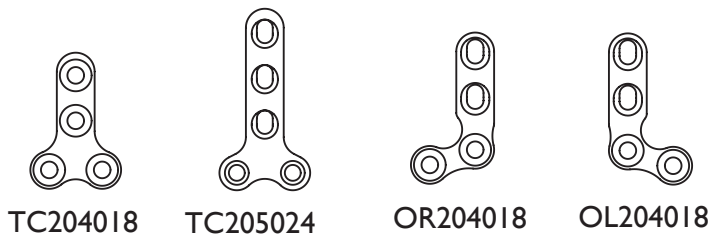
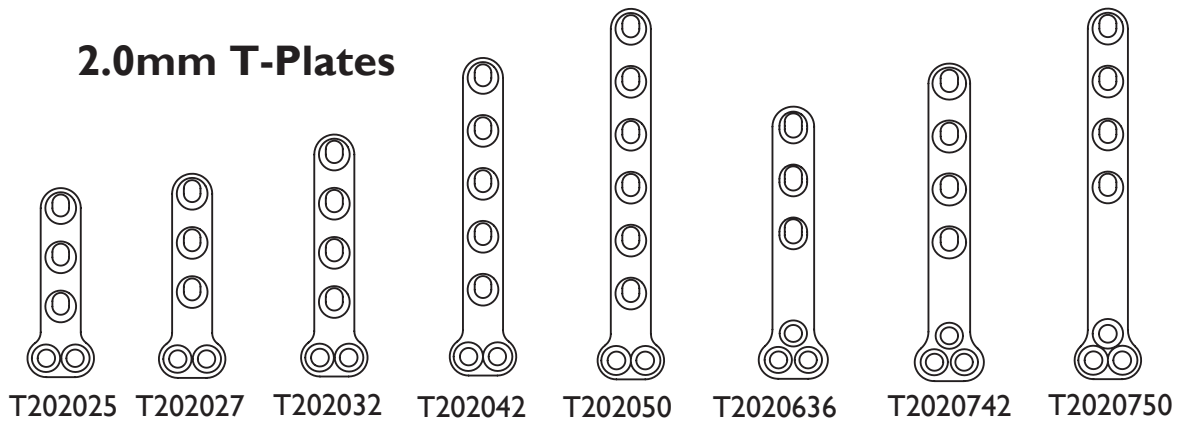

### 2.0/2.4/2.7mm Hybrid T-Plates

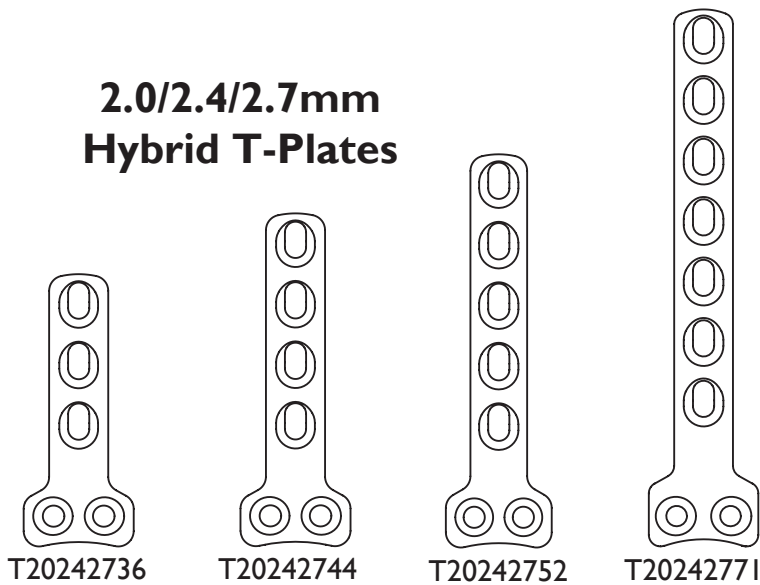

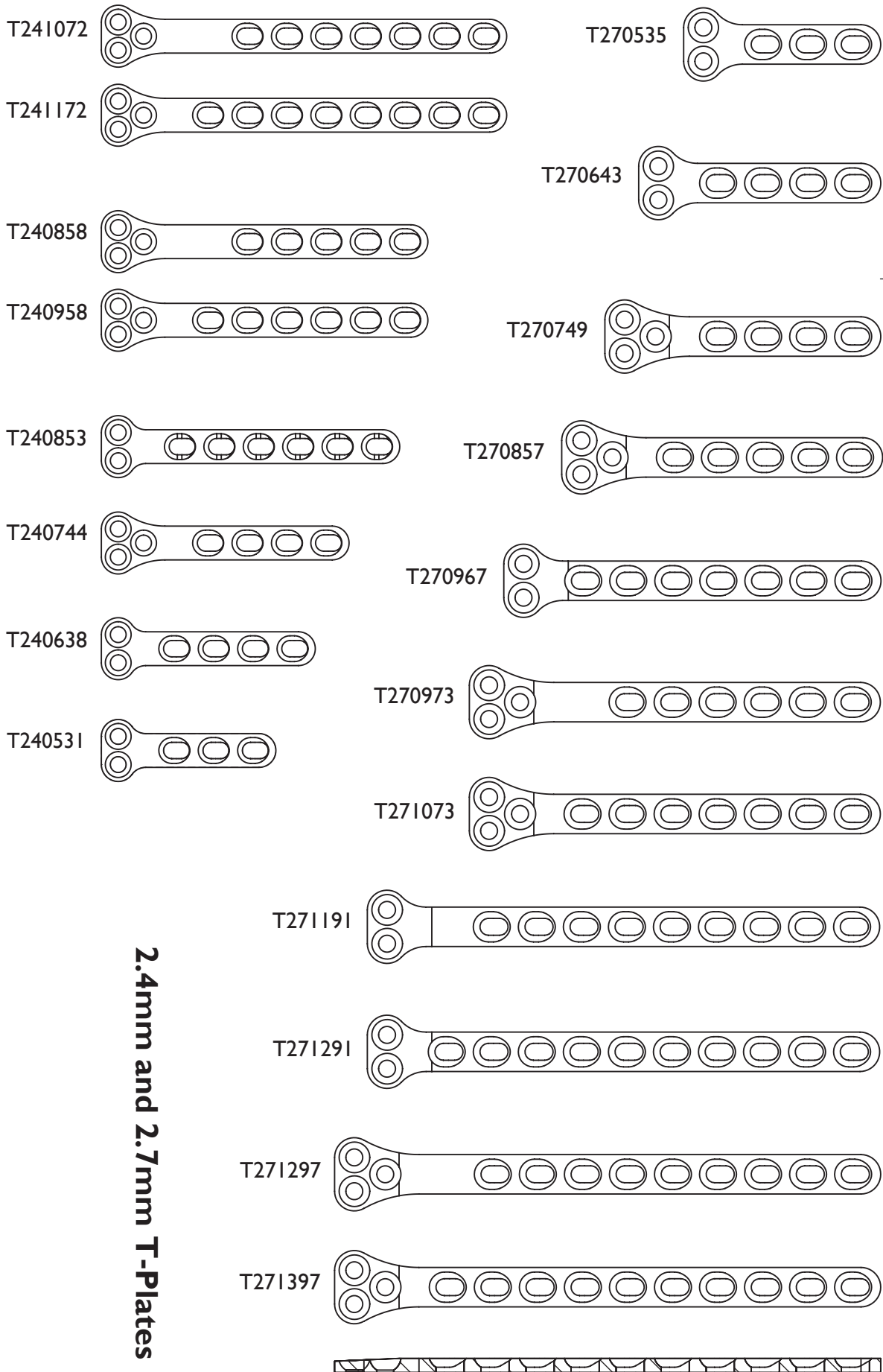
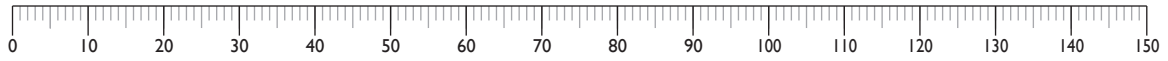

**2.4mm and 2.7mm T-Plates**

**Tapered profile**

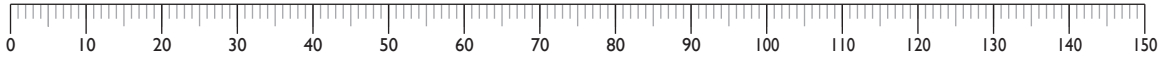

**2.7mm T-Plates**

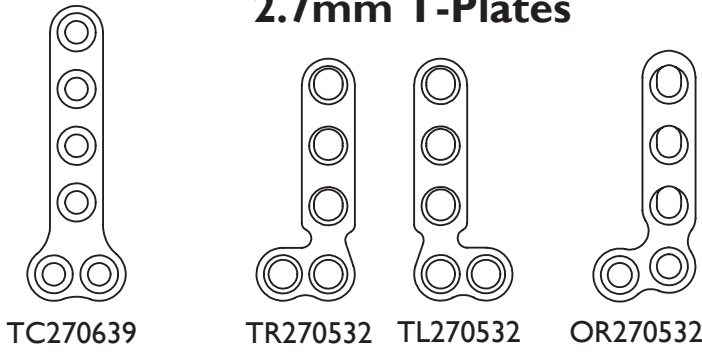

TC270639 TR270532 TL270532 OR270532

**3.5mm T-Plates**

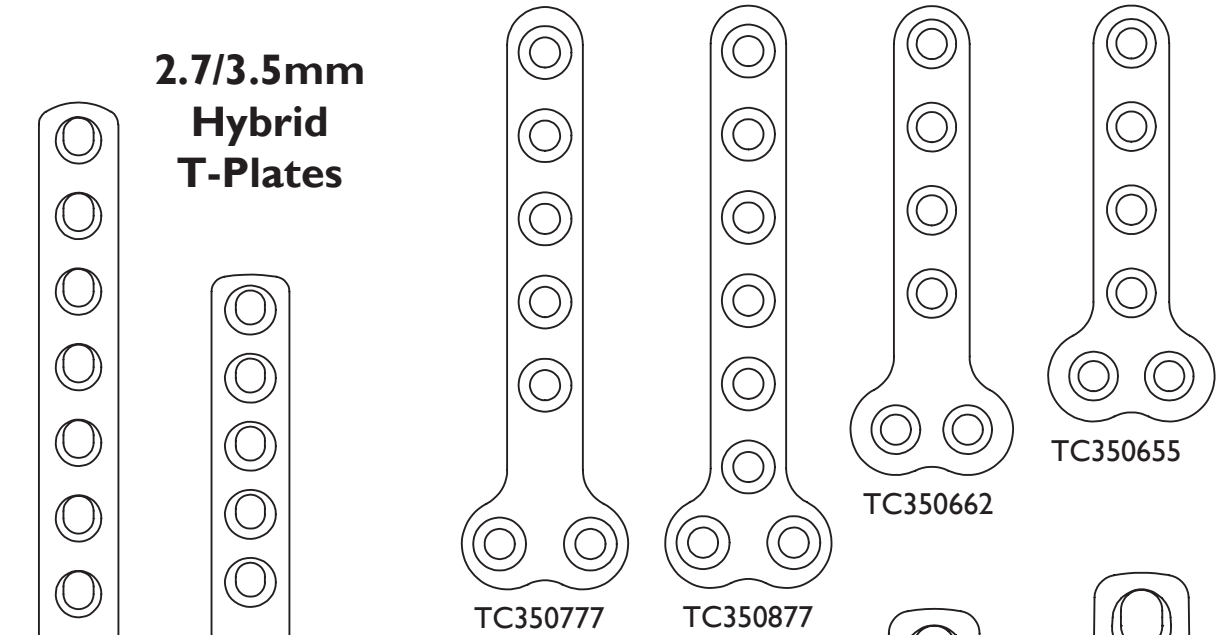

**2.7/3.5mm Hybrid T-Plates**

**Hybrid Anatomical T-Plates**

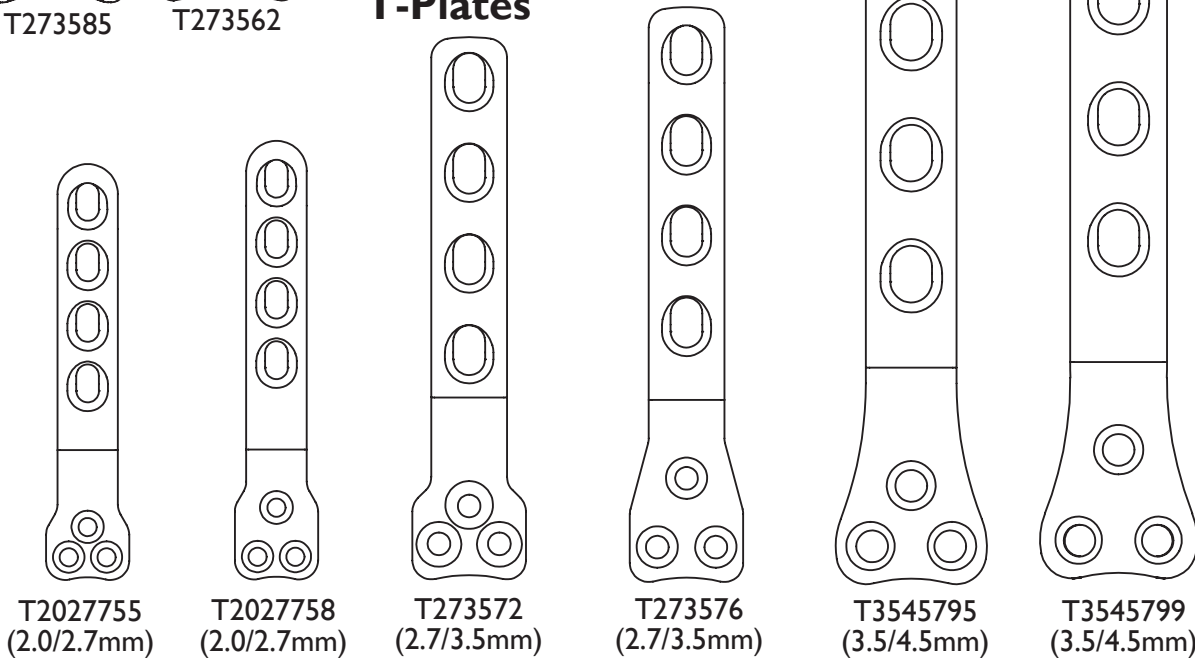

T2027755 (2.0/2.7mm) T2027758 (2.0/2.7mm) T273572 (2.7/3.5mm) T273576 (2.7/3.5mm) T3545795 (3.5/4.5mm) T3545799 (3.5/4.5mm)

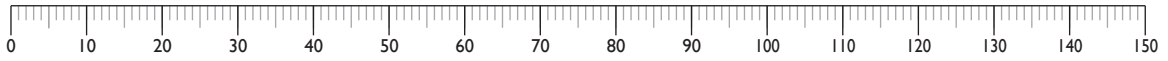

**2.0mm Locking T-Plates**

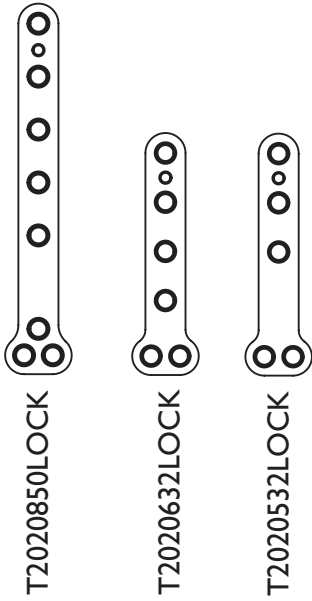

**2.4/2.7mm Locking T-Plates**

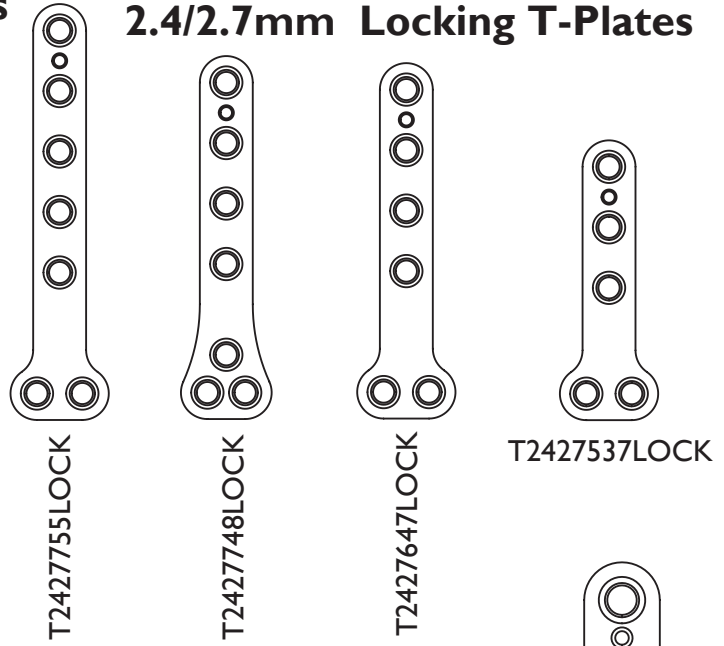

**3.5mm Locking T-Plates**

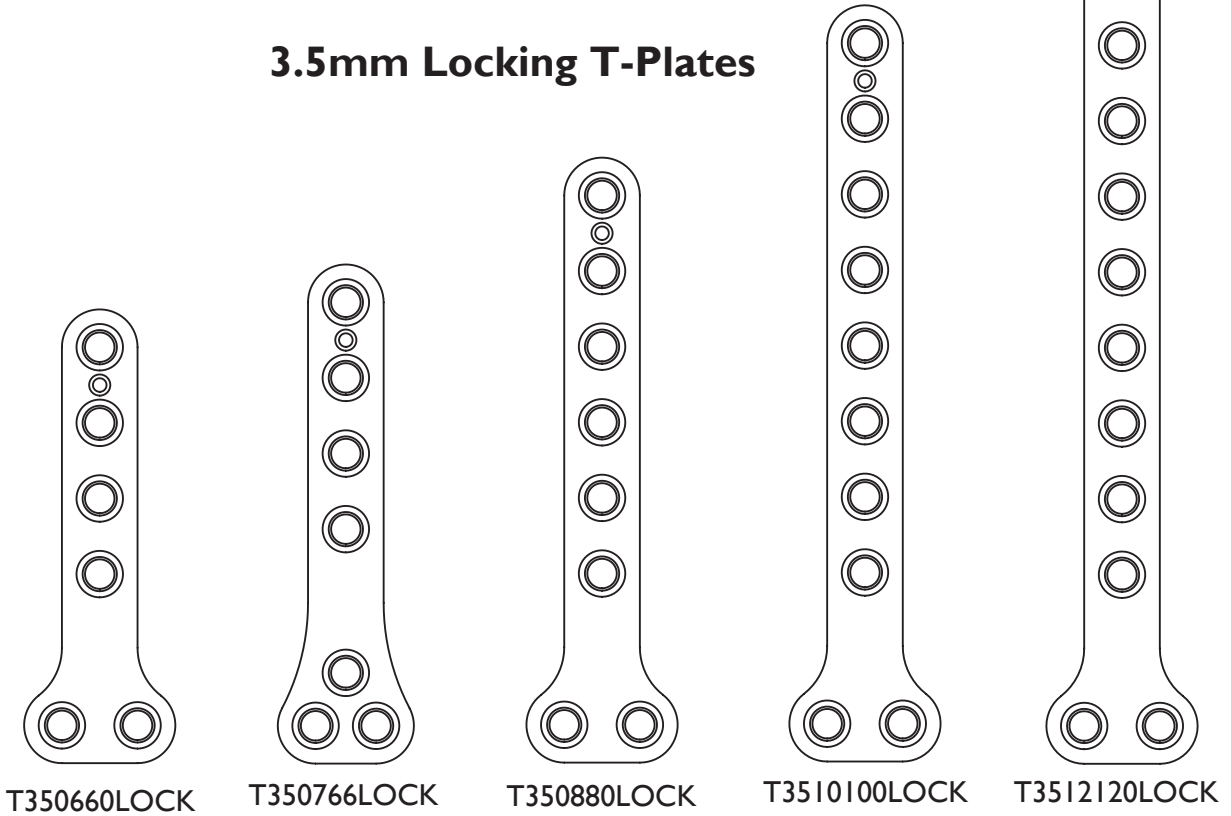

**LokRod™ Plates**

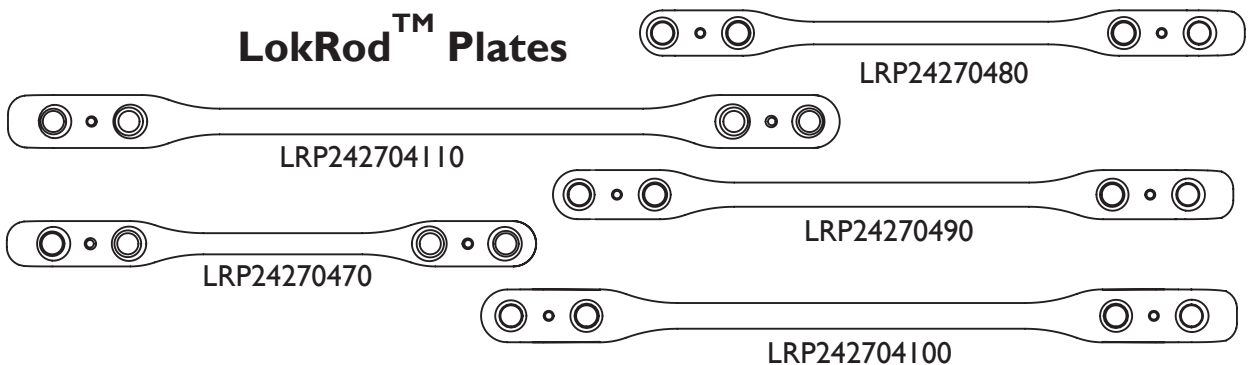

PLEASE NOTE THAT PLATE PROFILES ARE ACTUAL SIZE YOU WILL NEED TO COMPENSATE FOR X-RAY MAGNIFICATION • PROFILES FOR GUIDANCE ONLY PLATES MAY BE AMENDED AT ANY TIME



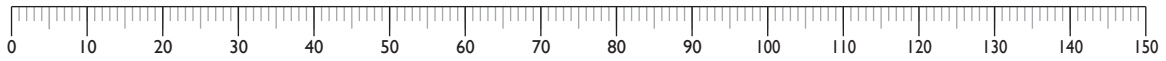

## 2.0mm Stacked Hole Locking Plates

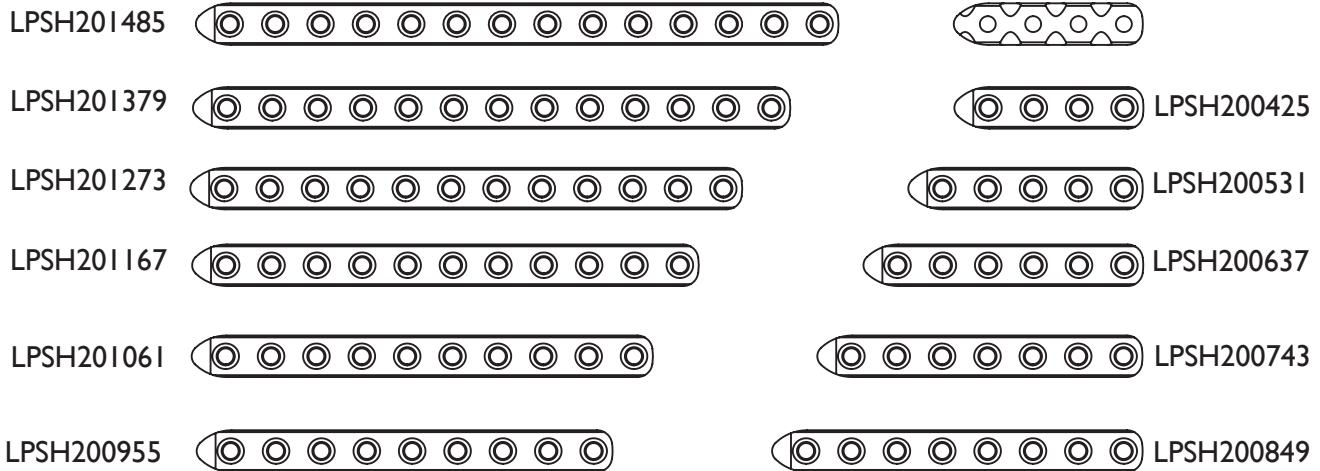

## 2.4mm Stacked Locking Hole Plates

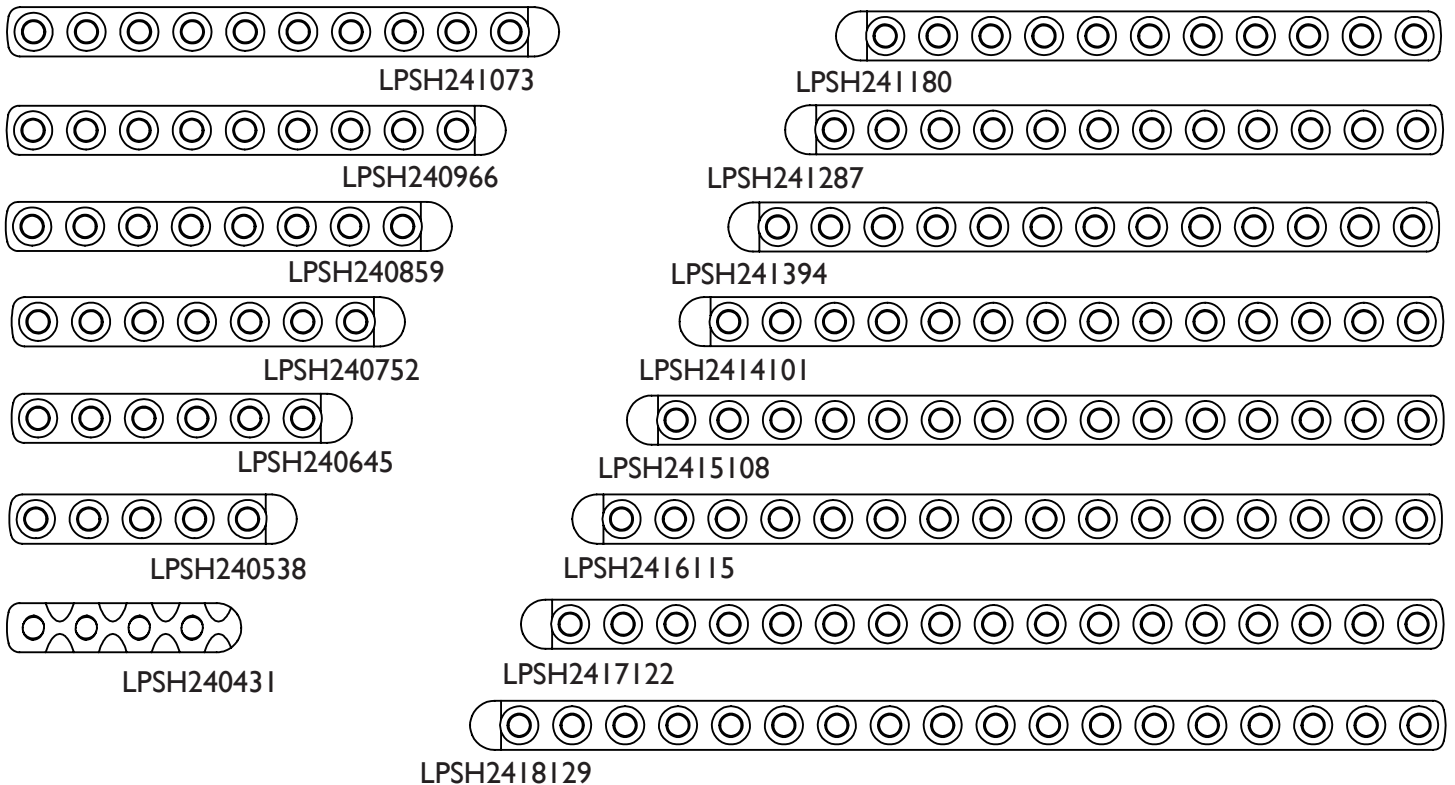

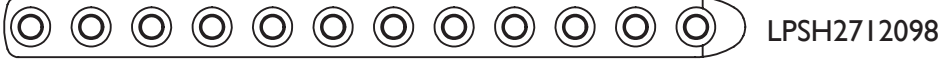

**2.7mm Stacked Locking Hole Plates**

**Cutttable Malleable Locking Plates**



15 holes, 205.5mm long

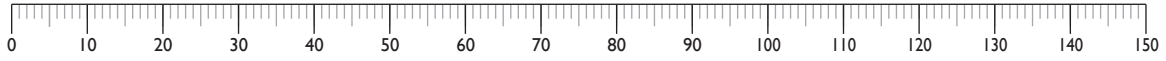

### 3.5mm Stacked Locking Hole Plates

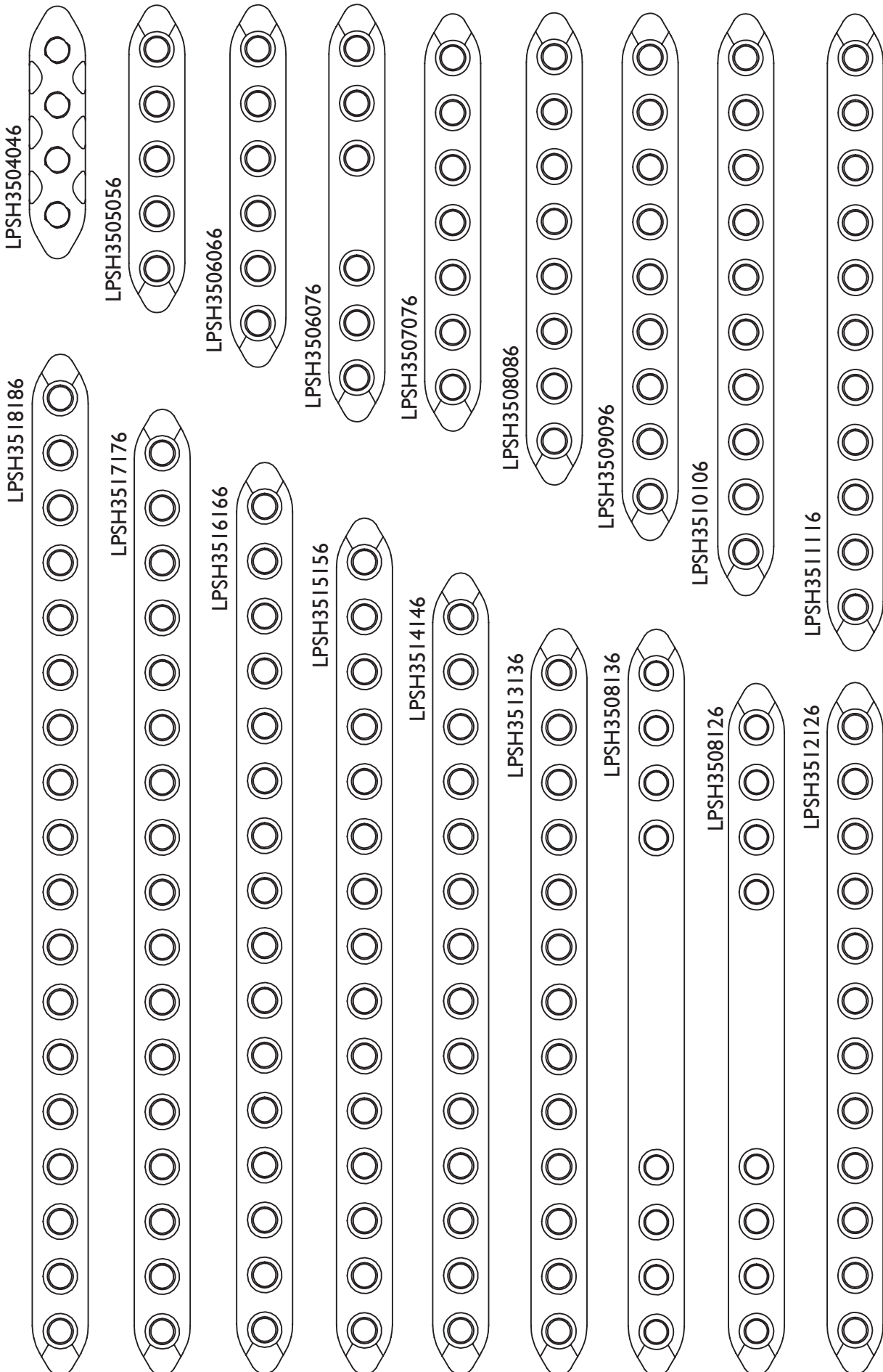

PLEASE NOTE THAT PLATE PROFILES ARE ACTUAL SIZE YOU WILL NEED TO COMPENSATE FOR X-RAY MAGNIFICATION • PROFILES FOR GUIDANCE ONLY PLATES MAY BE AMENDED AT ANY TIME

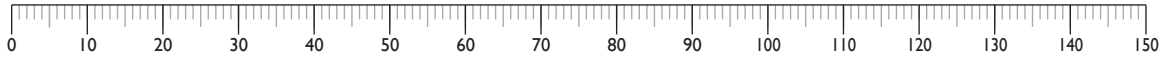

### 1.5mm Dynamic Locking Plates

### 2.0mm Dynamic Locking Plates



DLP1512072



DLP2014101



DLP1511066



DLP2013094



DLP1510060



DLP201287



DLP1509054



DLP2011080



DLP1508048



DLP2010073



DLP1507042



DLP2009066



DLP1506036



DLP2008059



DLP1505030



DLP2007052



DLP1504024



DLP2006045



DLP2005038



DL2004031

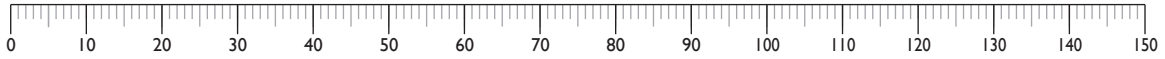

DLP2418164K



DLP2417155K



DLP2416146K



DLP2415137K



DLP2414128K



DLP2413119K or ...N

## 2.4mm Dynamic Locking Plates



DLP2412110K

DLP24xxxxxK = 2mm thick  
 DLP24xxxxxN = 1.7mm thick



DLP2411101K or ...N



DLP2404038N



DLP2410092K or ...N



DLP2405047K or ...N

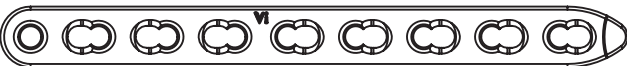

DLP2409083K or ...N



DLP2406056K or ...N



DLP2408074K or ...N



DLP2407065K or ...N

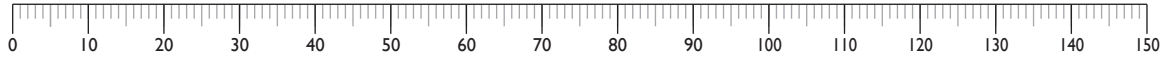

DLP2718164



DLP2717155



DLP2716146



DLP2715137



DLP2714128



DLP2713119



DLP2712110



DLP2711101



DLP2704038



DLP2710092



DLP2705047



DLP2709083



DLP2706056



DLP2708074



DLP2707065



**2.7mm  
Dynamic  
Locking  
Plates**

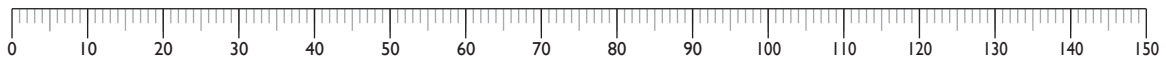

### 3.5mm Dynamic Locking Plates

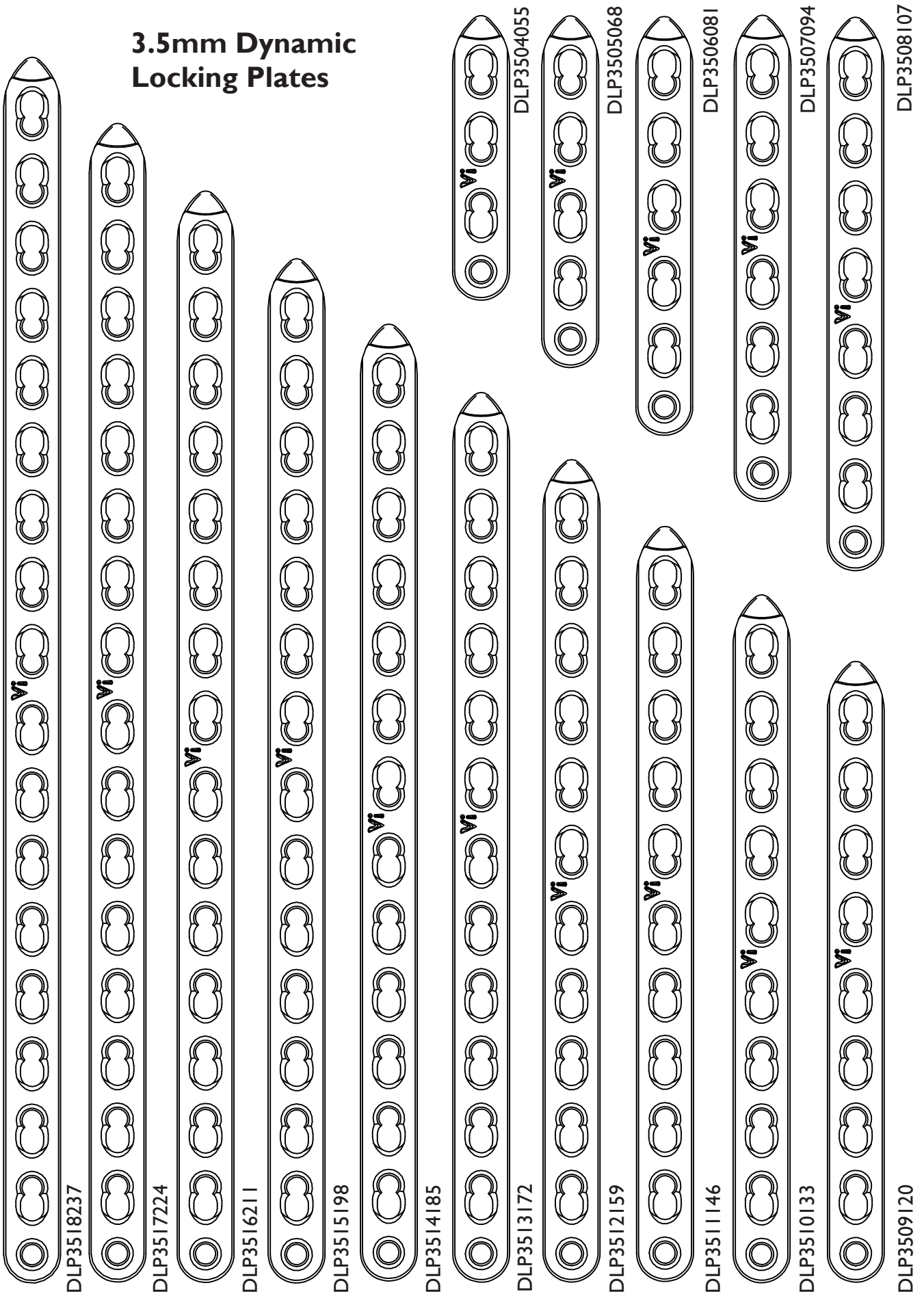



**Butterfly Plates**

1.5mm

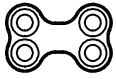

BTFP15414

2.0mm

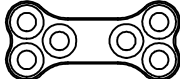

BTFP20623

**TPO Plates**

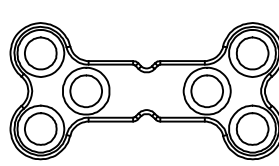

090179

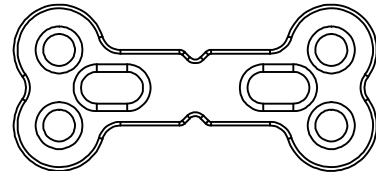

090167

**Acetabular Plates**



AP200400xs (2.0)



AP2004001L (2.0)

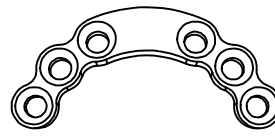

AP270603 (2.7)



AP350605 (3.5)



AP200400 (2.0)



AP240406 (2.4)

**Contoured in 3 Dimensions**



AP200401 (2.0)



AP270602 (2.7)



AP350604 (3.5)

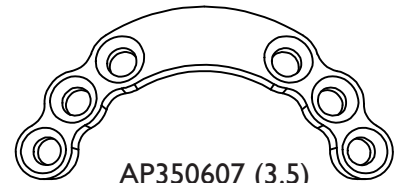

AP350607 (3.5)

**Reconstruction Plates**

2.7mm



RC271296



RC271080



RC270864



RC270648

RC350558

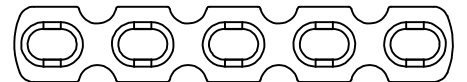

RC350782

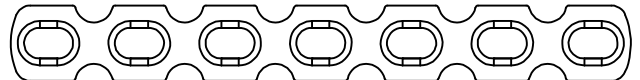

RC350894



RC3512142

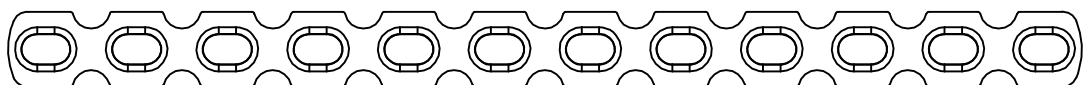

3.5mm

Also available but not shown:

RC270756, RC270972, RC271188, RC3509106.





### Cuttable Plate Range

<b>1.5mm</b> CPI5413030			
CPI5413030B			
CPI5413027			
CPI5413027B			
<b>2.0mm</b> CP205150			
CP205150B			
CP20515027			
CP20515027B			
<b>2.4mm</b> CP2455150			
CP245515024			
<b>2.7mm</b> CP276150			
CP276150B			
CP27615022			
CP27615022B			
<b>3.5mm</b> CP3575150			
CP357515018			
<b>1.5mm</b> CMI5413030			
<b>2.0mm</b> CM205150			
<b>2.4mm</b> CM2455150			
<b>2.7mm</b> CM276150			
<b>3.5mm</b> CM3575150			
<b>2.0mm</b> DCCP206150			
<b>2.4mm</b> DCCP247150			
<b>2.7mm</b> DCCP278150			

VCP202427 (2.0/2.4/2.7, 1.2mm thick, 300mm long, 50 holes) / VCP202427B, 2.0mm thick, 300mm long, 50 holes

PLEASE NOTE THAT PLATE PROFILES ARE ACTUAL SIZE YOU WILL NEED TO COMPENSATE FOR X-RAY MAGNIFICATION • PROFILES FOR GUIDANCE ONLY PLATES MAY BE AMENDED AT ANY TIME

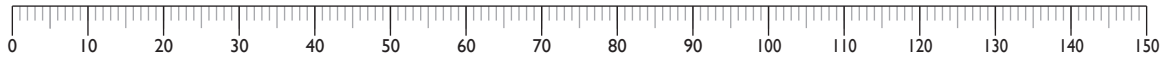

### I.0mm Series

C100210	CMI0390
C100314	
C100418	CPI0390
C100522	
C100626	CPI039027
C100730	
C100834	CPI0491
C100938	
C101042	CPI049120
T101016	T101018
T101020	T101022
T101024	T101026
	T101021
	T101027

### Intertarsal Arthrodesis

152925 (2.7/3.5)		
152921 (2.7/3.5)		
152922 (2.7/2.7)		
152920 (2.0/2.7)		
152920SC (2.0/2.7)		
152923 (2.0/2.0)		
152924 (1.5/2.0)		

**Elbow Arthrodesis**

152950 (2.7/3.5) RIGHT  
152951 (2.7/3.5) LEFT

Locking version also available.  
152950LOCK (2.7/3.5) RIGHT  
152951LOCK (2.7/3.5) LEFT

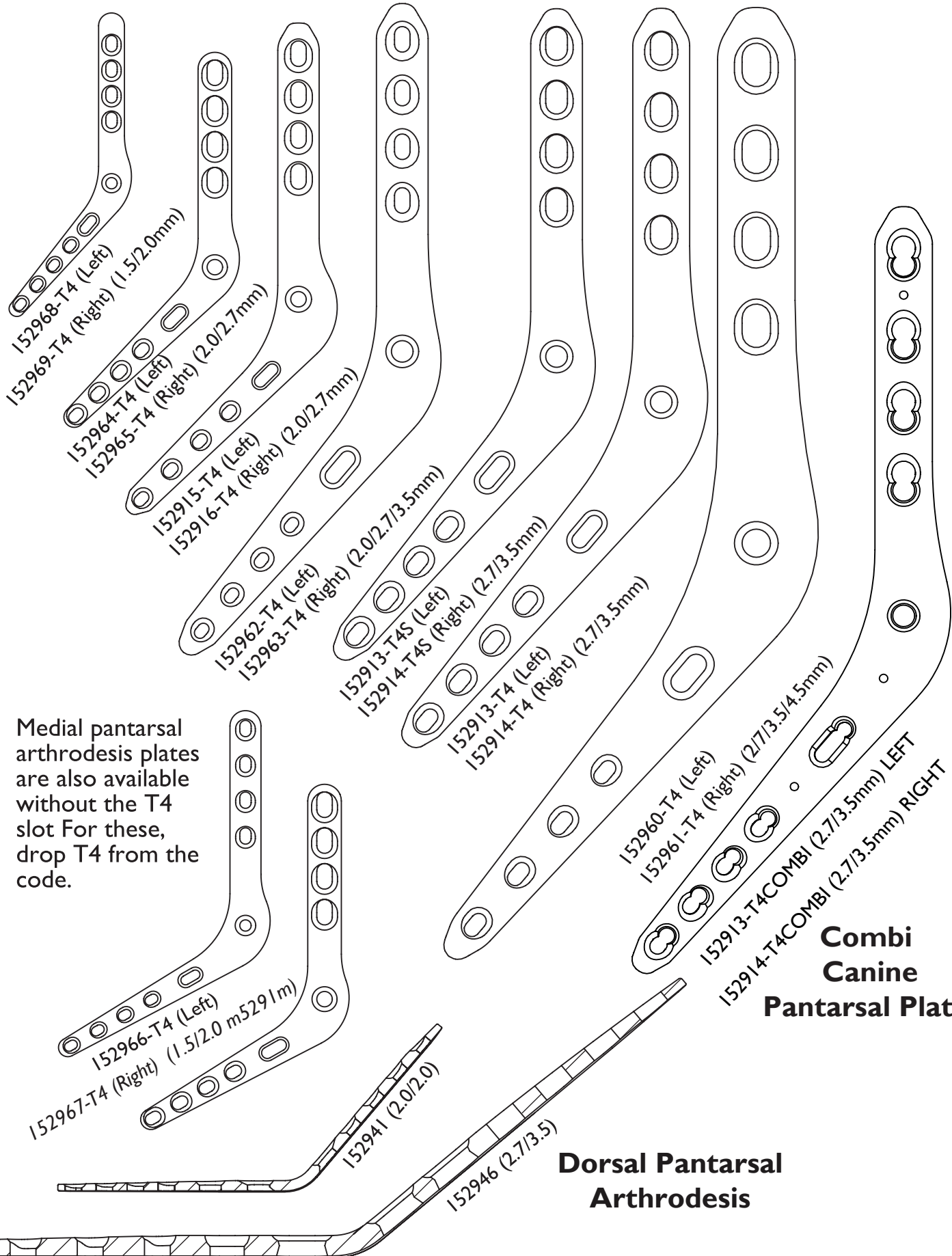
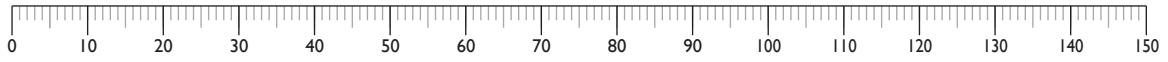

Medial pantarsal arthrodesis plates are also available without the T4 slot For these, drop T4 from the code.

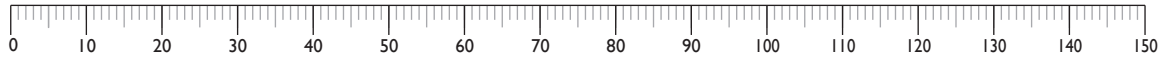

### Combi T-Plates

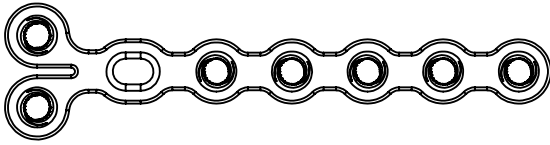

T1515836LOCK



T151532COMBI



T1515735COMBI

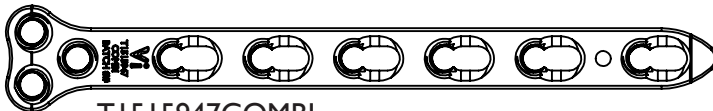

T1515947COMBI

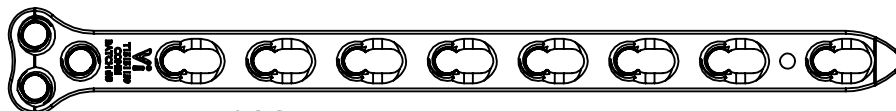

T15151159COMBI

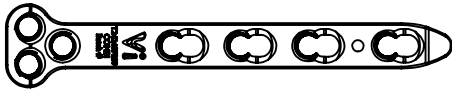

T242407059COMBI



T242408068COMBI



T242409077COMBI

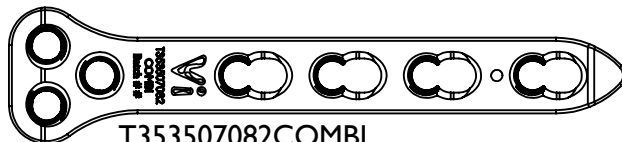

T353507082COMBI

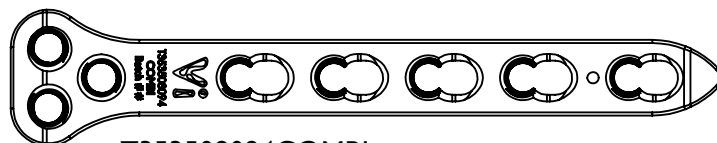

T353508094COMBI

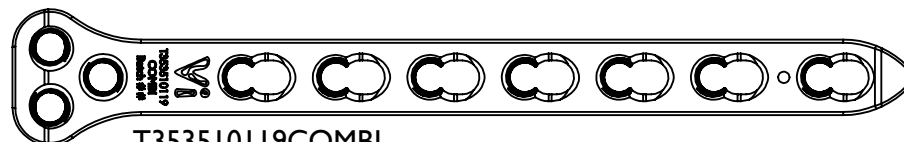

T353510119COMBI

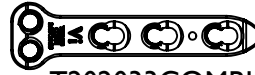

T202033COMBI



T202040COMBI

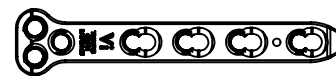

T2020743COMBI

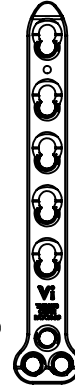

T2020850COMBI



T20201065COMBI



T20201279COMBI

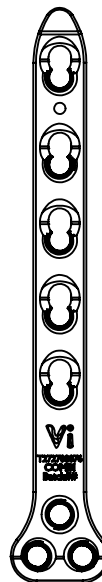

T272708076COMBI

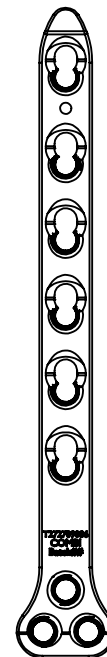

T272709086COMBI

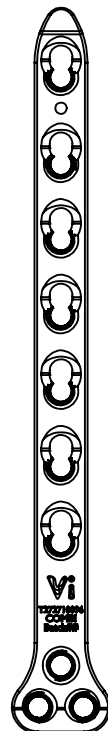

T272710096COMBI

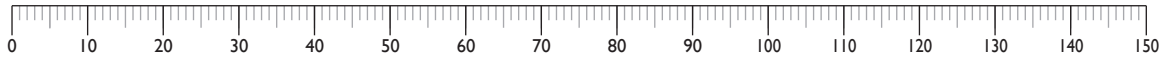

### Locking Pancarpal Arthrodesis Plates

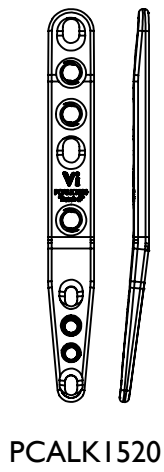

PCALK1520

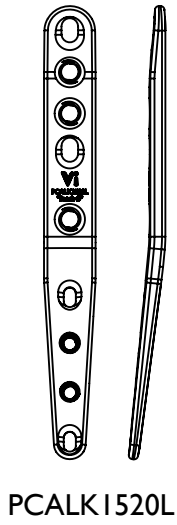

PCALK1520L

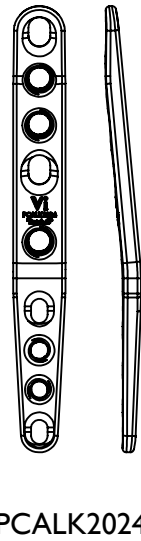

PCALK2024

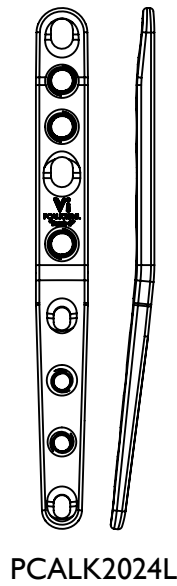

PCALK2024L

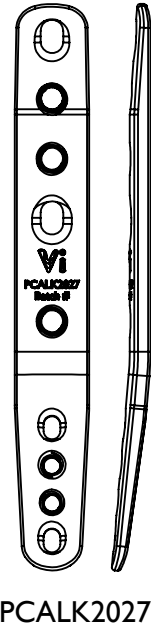

PCALK2027

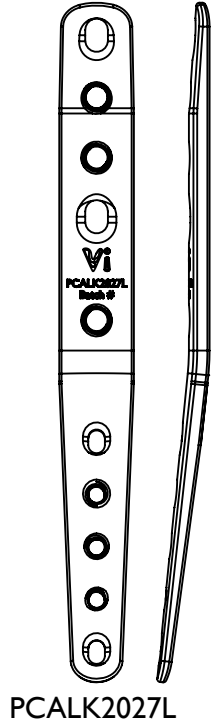

PCALK2027L

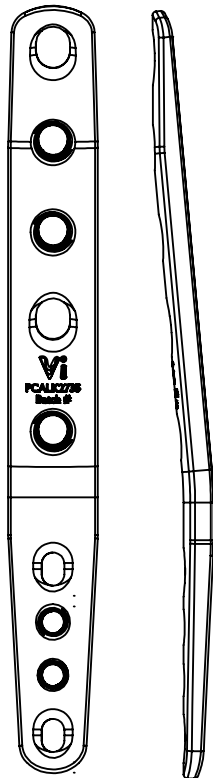

PCALK2735

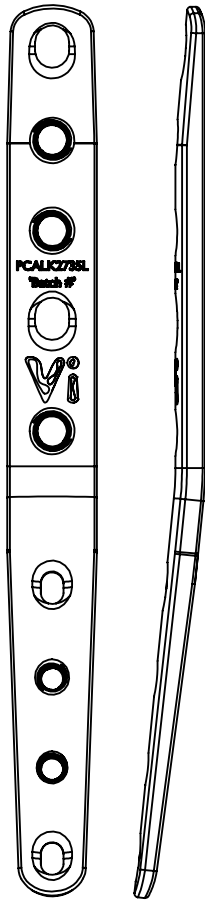

PCALK2735L

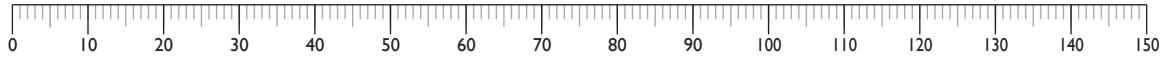

**I52909 (DCP)**  
(3.5/4.5)

**I52907XL (DCP)**  
(3.5/3.5)

**I52907 (DCP)**  
**I52908 (ROUND)**  
(3.5/3.5)

**I52903 (DCP)**  
**I52904XL (ROUND)**  
(2.7/3.5)

**I52903XL (DCP)**  
**I52904 (ROUND)**  
(2.7/3.5)

**I52902 (DCP)**  
(2.0/2.7)

**I52905 (DCP)**  
**ROUND I52906**  
(2.0/2.7)

**I52905XL (DCP)**  
(2.0/2.7)

**I52912XL (DCP)**  
(2.0/2.0)

**I5291XL (DCP)**  
(1.5/2.0)

**I52912 (DCP)**  
(2.0/2.0)

**I52911 (DCP)**  
(1.5/2.0)

**I52970 (DCP)**  
(1.0/1.5)

Locking versions of select pancarpal arthrodesis plates are available.

**Pancarpal Arthrodesis Plates**

**Partial Carpal Arthrodesis Plates**

**I52930**  
(2.7/3.5)

**I52931**  
(2.0/2.4/2.7)

**I52932**  
(1.5/2.0)

**Feline Forelimb Salvage Plate**

**I52910**  
(1.5/2.0)

PLEASE NOTE THAT PLATE PROFILES ARE ACTUAL SIZE YOU WILL NEED TO COMPENSATE FOR X-RAY MAGNIFICATION • PROFILES FOR GUIDANCE ONLY PLATES MAY BE AMENDED AT ANY TIME

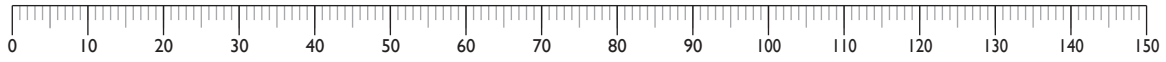

152980 (3.5 locking/2.7/3.5/4.5) NOTE: Scale 1:2



152903XXL (2.7/3.5) NOTE: Scale 1:2

### Longer Plates

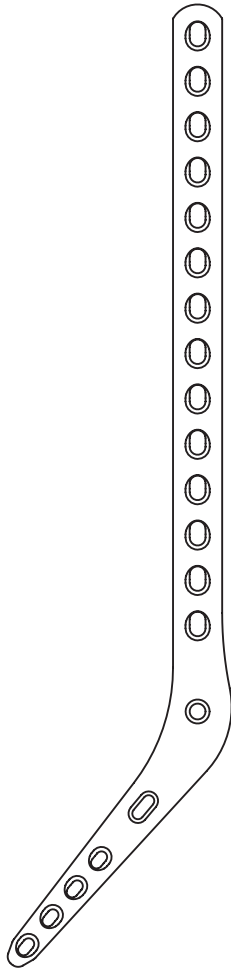

152913-T4XL (Left)  
152914-T4XL  
(Right) 2.7/3.5mm  
NOTE: Scale 1:2

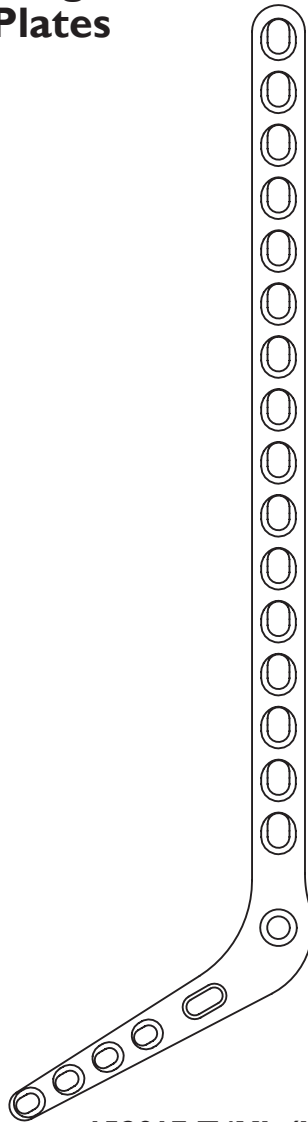

152917-T4XL (Left)  
152918-T4XL  
(Right) 2.0/2.7mm  
NOTE: Scale 1:1

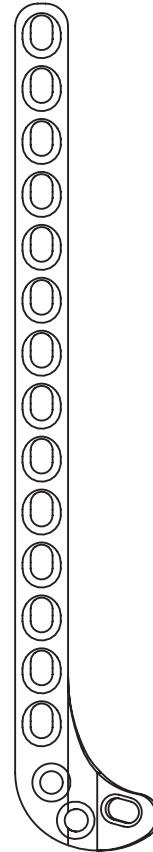

152711L-XL (Left)  
152711R-XL  
(Right) 2.4mm  
NOTE: Scale 1:1

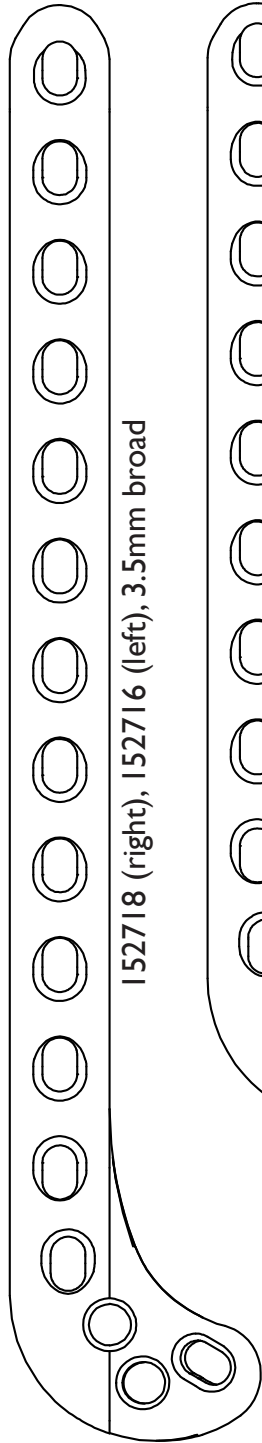

152718 (right), 152716 (left), 3.5mm broad

**Supra-Condylar Plates (SCPs) & Supra-Condylar Osteotomy Plates (SCOP): for lateral application**

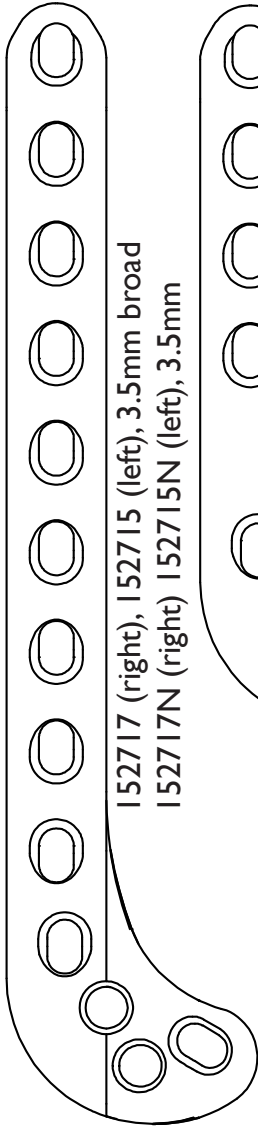

152717 (right), 152715 (left), 3.5mm broad  
152717N (right) 152715N (left), 3.5mm

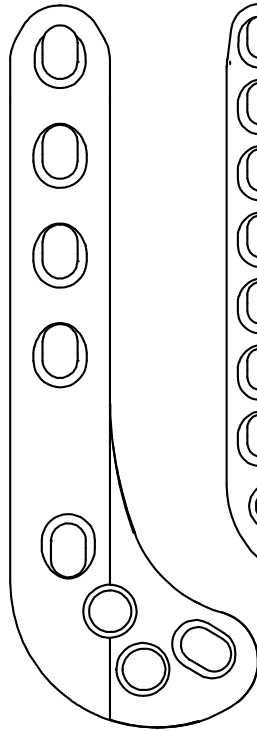

152620 (right), 152625 (left), 3.5mm broad  
152610 (right), 152615 (left), 3.5mm

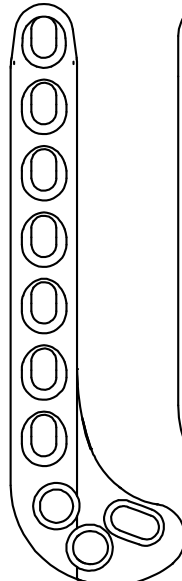

152714 (right)  
152712 (left)  
2.7mm

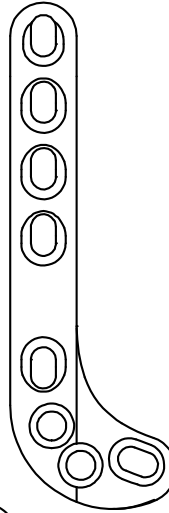

152600 (right)  
152605 (left)  
2.7mm

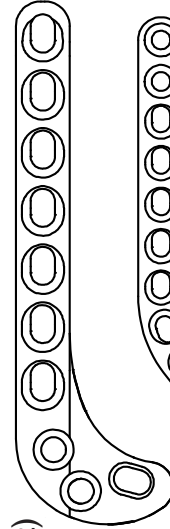

152711R (right)  
152711L (left)  
2.4mm



152700 (right),  
152710 (left)  
2.0mm



152700XL (right), 152710XL, 2.0mm

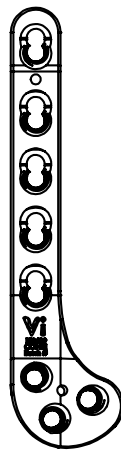

**Feline Combi**

**Supracondylar Plate (Locking)**

152609COMBI (left)

152608COMBI (right)

2.0mm

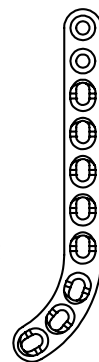

152704 (right)  
1.5mm

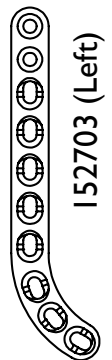

152703 (Left)  
1.5mm



152701 (right),  
152709 (left)  
2.0mm

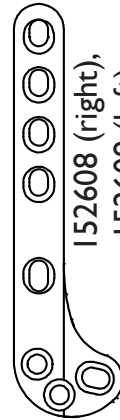

152608 (right),  
152609 (left)  
2.0mm



152612 (right),  
152613 (left)  
2.0mm





**Cloverleaf TTO/TPLO Plates**

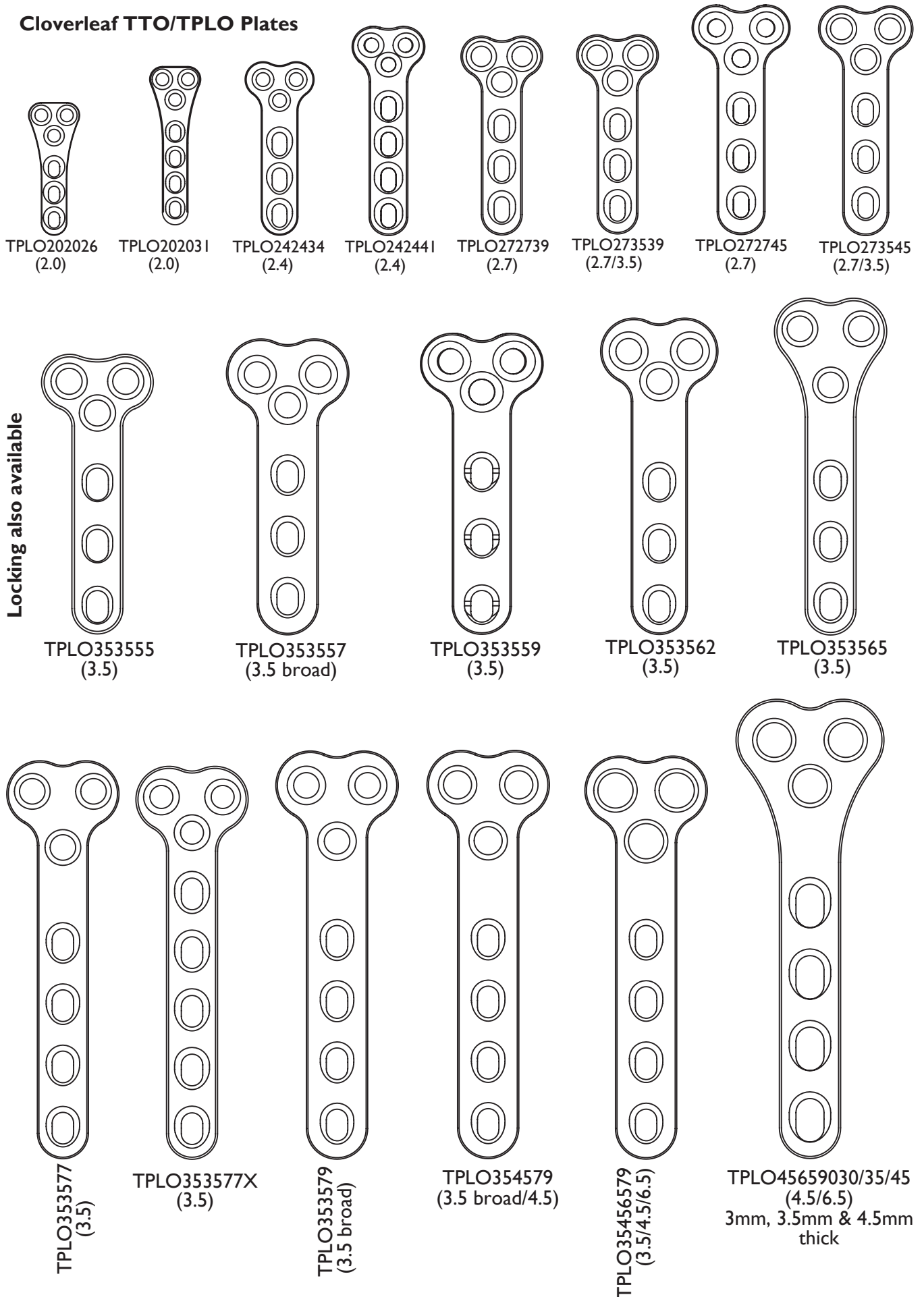

PLEASE NOTE THAT PLATE PROFILES ARE ACTUAL SIZE YOU WILL NEED TO COMPENSATE FOR X-RAY MAGNIFICATION • PROFILES FOR GUIDANCE ONLY PLATES MAY BE AMENDED AT ANY TIME

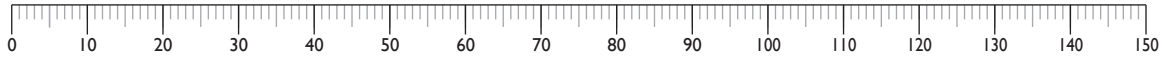

### Slocum Style TPLO Plates

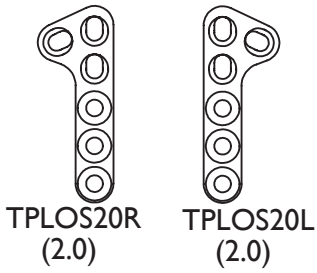

TPLOS20R  
(2.0)

TPLOS20L  
(2.0)

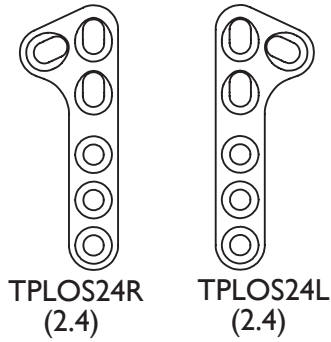

TPLOS24R  
(2.4)

TPLOS24L  
(2.4)

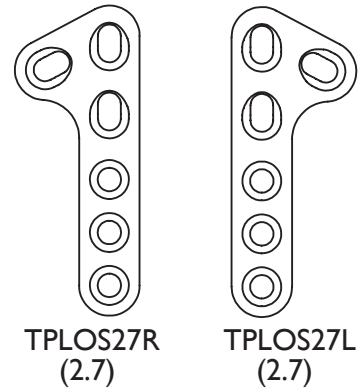

TPLOS27R  
(2.7)

TPLOS27L  
(2.7)

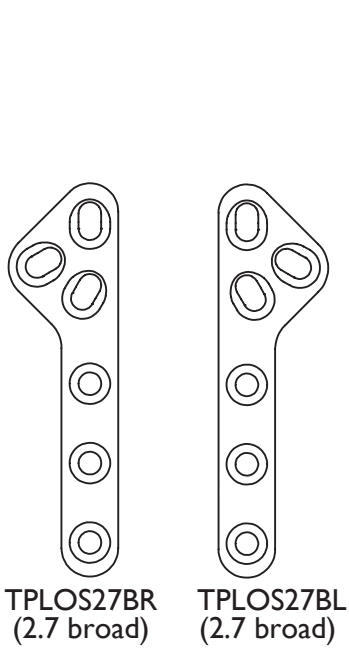

TPLOS27BR  
(2.7 broad)

TPLOS27BL  
(2.7 broad)

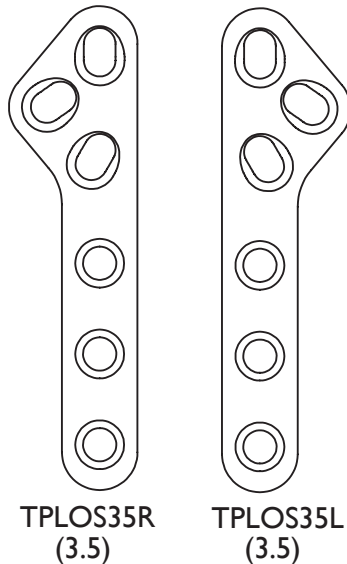

TPLOS35R  
(3.5)

TPLOS35L  
(3.5)

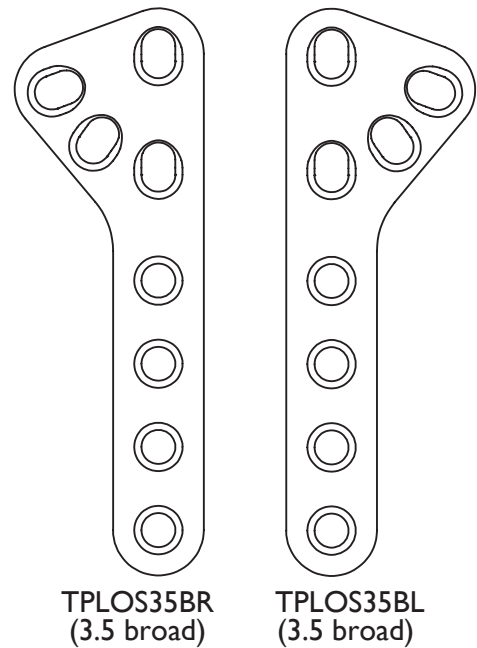

TPLOS35BR  
(3.5 broad)

TPLOS35BL  
(3.5 broad)

### Locking TPLO Plates

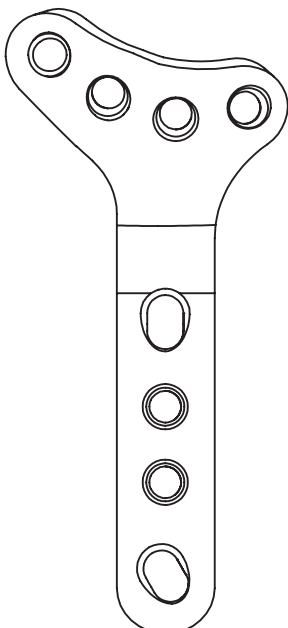

TPLO35BLPCR  
(3.5 broad)

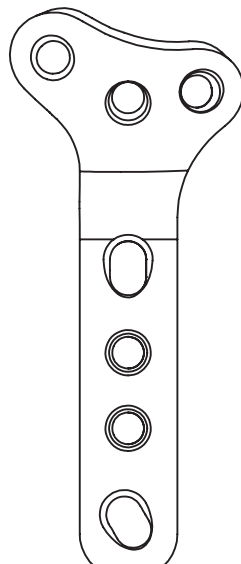

TPLO35MLPCR  
(3.5)

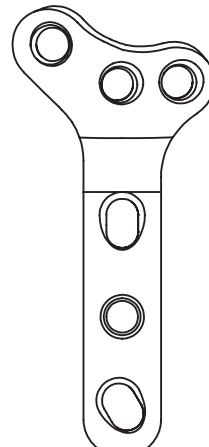

TPLO35LPCR  
(3.5)

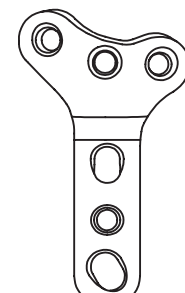

TPLO27LPCR  
(2.7)

Replace the final R with L for left sided plates

PLEASE NOTE THAT PLATE PROFILES ARE ACTUAL SIZE YOU WILL NEED TO COMPENSATE FOR X-RAY MAGNIFICATION • PROFILES FOR GUIDANCE ONLY PLATES MAY BE AMENDED AT ANY TIME



### Delta TPLO Plates

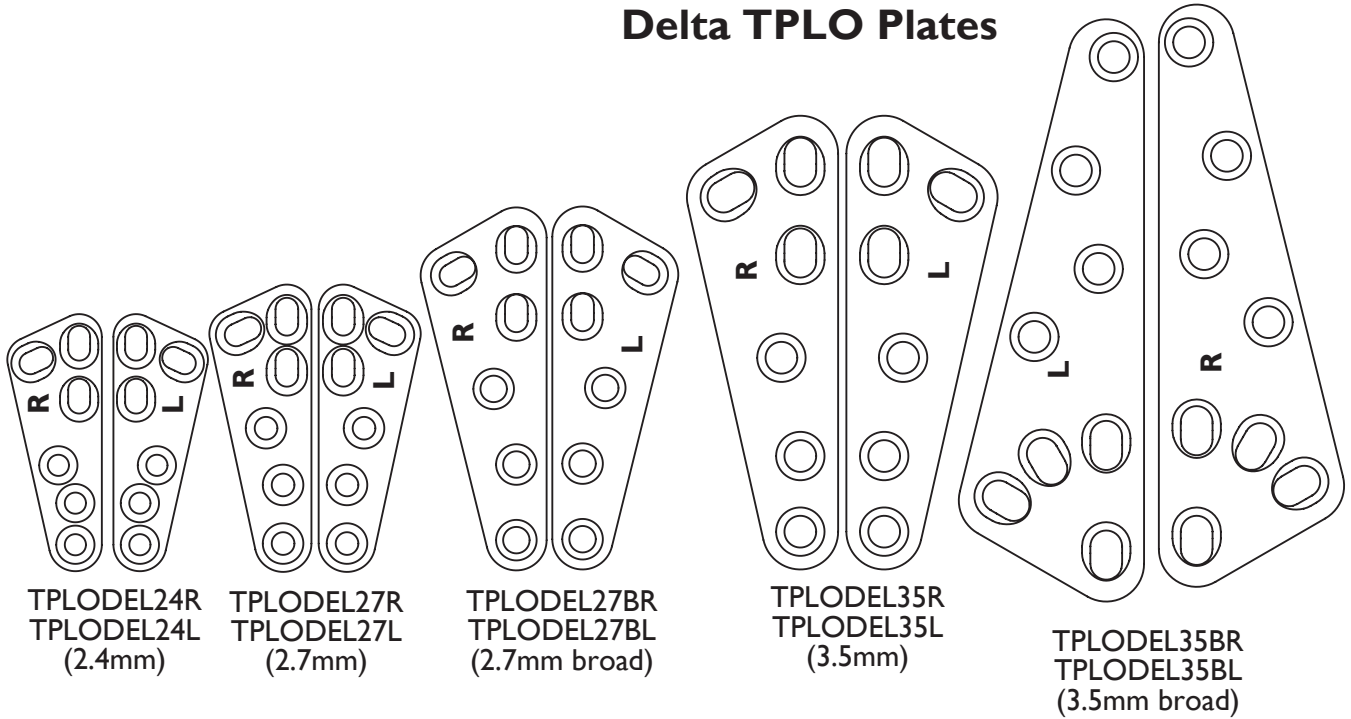

### Vi Locking TPLO Plates

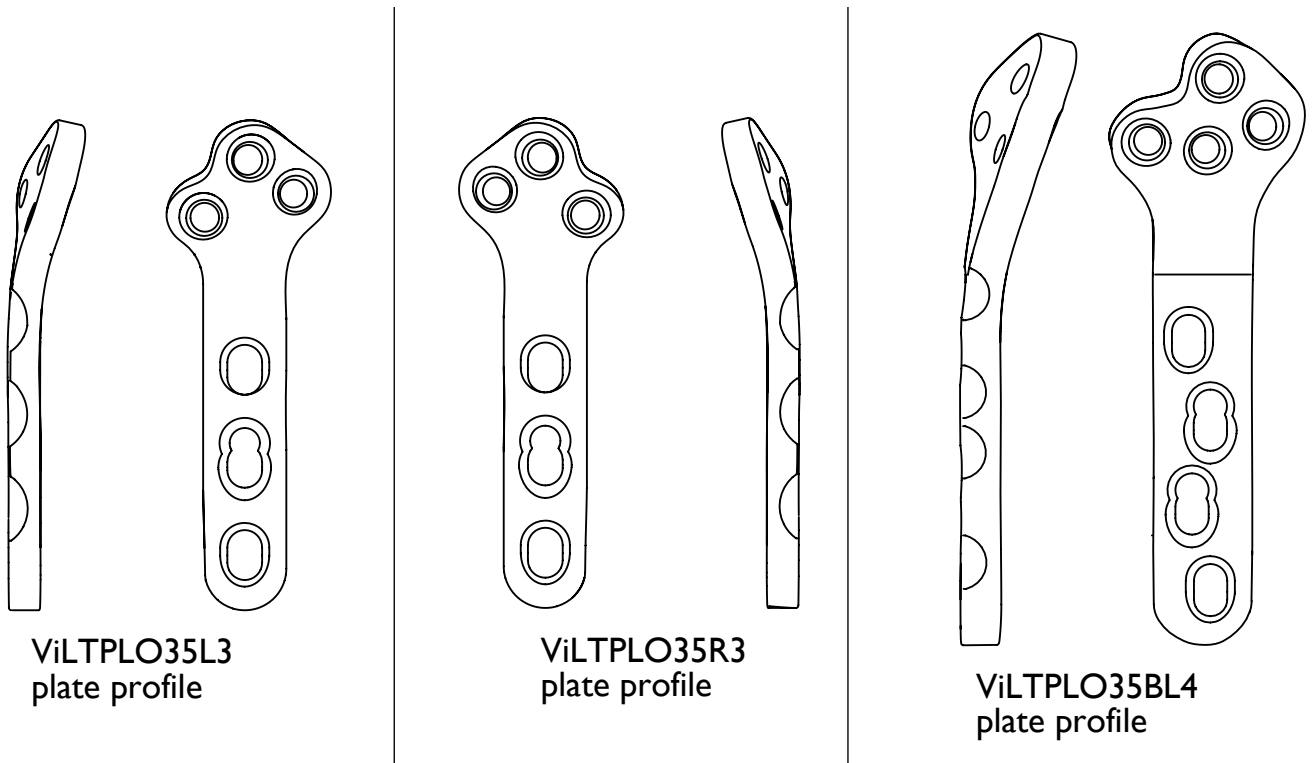

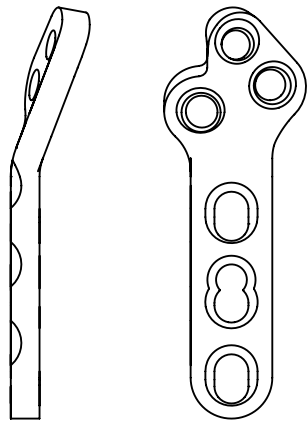
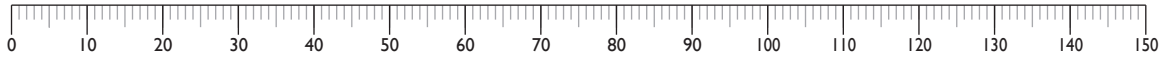

**ViLTPLO35SL3**  
plate profile

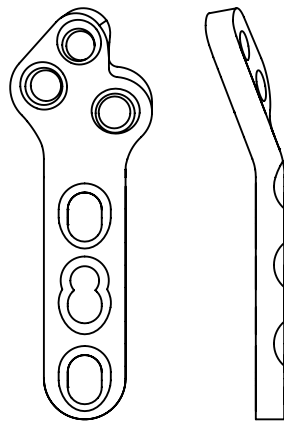

**ViLTPLO35SR3**  
plate profile

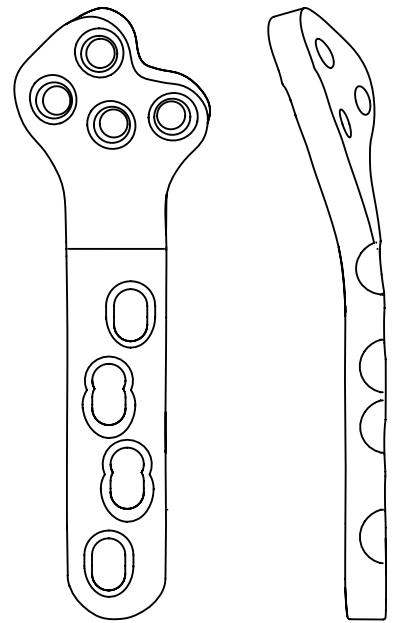

**ViLTPLO35BR4**  
plate profile

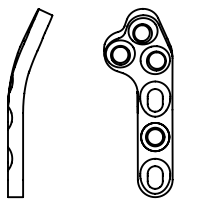

**ViLTPLO15L3**  
plate profile

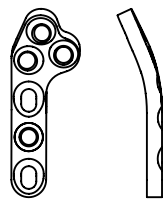

**ViLTPLO15R3**  
plate profile

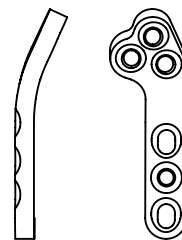

**ViLTPLO20L**  
plate profile

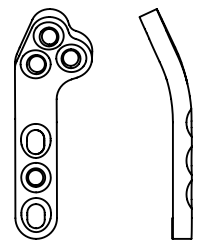

**ViLTPLO20R**  
plate profile

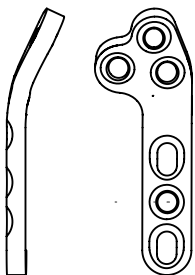

**ViLTPLO24L**  
plate profile

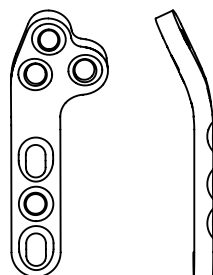

**ViLTPLO24R**  
plate profile

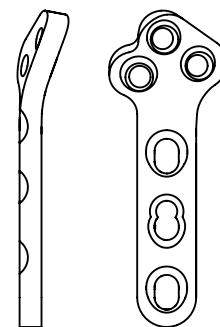

**ViLTPLO27L3**  
plate profile

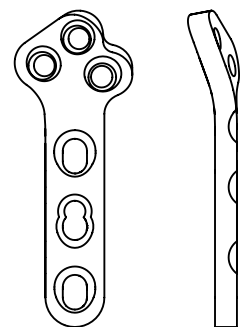

**ViLTPLO27R3**  
plate profile

# Index

## Index

1.0mm Compression Plates . . . . .	89
1.0mm Cortical Self Tapping Screws . . . . .	89
1.0mm Cuttable Plates . . . . .	89
1.0mm Drill Guide . . . . .	138
1.0mm Plates and Screws . . . . .	89
1.0mm Plating Kit . . . . .	87
1.0mm Plating System - Drill Bits . . . . .	89
1.0mm Plating System - Drill Guide . . . . .	89
1.0mm Plating System - Plate Holding Forceps . . . . .	89
1.0mm T-Plates . . . . .	89
1/2 Teeth Dissecting Forceps . . . . .	186
3CON Stems . . . . .	77

## A

A Wires . . . . .	133
A/K Wire Bender . . . . .	16
A/K Wire Dispenser . . . . .	135
A/K Wire Extraction Forceps . . . . .	24
A/K Wire Holders . . . . .	135
A/K Wire/Pin Punches . . . . .	16
AAS Darvall Warm Air System . . . . .	238
Abdominal Retractors . . . . .	188
Abdominal Surgery . . . . .	200-203
Acculan 4 Power Tools . . . . .	155
Acetabular Plates . . . . .	104
Adjustable Bone Saw . . . . .	16,67
Adjustable Drill Guide . . . . .	61,70,111,138
Adson Dissecting Forceps . . . . .	187
Adson Suction Tip . . . . .	236
Aesculap Acculan 4 Power Tools . . . . .	155
Air Hoses . . . . .	163-164
Air Instrument Care Products . . . . .	164
Air Regulators . . . . .	164
Airway Surgery . . . . .	195-196
Alligator Grasping Forceps - Arthroscopic . . . . .	75
Allis Tissue Forceps . . . . .	176
Allis Tissue Forceps - Angled . . . . .	196
Ameroid Constrictors . . . . .	202
Anaesthetic Circuits - Heated . . . . .	239
Anaesthetic Monitoring . . . . .	239-240
Anal Sac Excision Kit . . . . .	207
Angiotribs . . . . .	200
Angled Allis Tissue Forceps . . . . .	196
AO Type Periosteal Elevator . . . . .	15,219
AO-Fit Handles . . . . .	128-130
AO-Fit/Quick Release Drill Bits . . . . .	131-132
Apical Elevator . . . . .	219
Arruga Capsule Forceps . . . . .	214
Artery Forceps . . . . .	178
Artery Forceps - Left Handed . . . . .	192
Arthrodesis Plates - Carpal . . . . .	105
Arthrodesis Plates - Elbow . . . . .	108
Arthrodesis Plates - Tarsal . . . . .	106-107
Arthrodesis Wires . . . . .	133
Arthroscopic Stifle Lever VSTL . . . . .	63,74
Arthroscopy Instruments . . . . .	74-75
Artificial Urethral Sphincter . . . . .	205
Askir Suction Machine . . . . .	236
ASYM Plates . . . . .	96
Atraumatic Small Bowel Clamp . . . . .	203
Atraumatic Towel Clip . . . . .	186
Aural Haematoma System (Implants Only) . . . . .	197
Aural Surgery . . . . .	197
AUS System . . . . .	205

## B

Babcock Tissue Forceps . . . . .	179
Backhaus Towel Clip . . . . .	186
Balfour Retractor . . . . .	188,202
Ball & Socket Towel Clamp . . . . .	186
Banana Knife - Arthroscopic . . . . .	74
Bandage Scissors . . . . .	183
Bar Set - Small (for BOAS Mouth Gag) . . . . .	195
Bar Sleeve - Silicone (for BOAS Mouth Gag) . . . . .	195
Barraquer Speculum . . . . .	213
Basic Surgery Stitch Up Kit . . . . .	176
Baskets for Premium Instrument Boxes . . . . .	229
Batteries - Acculan 4 . . . . .	155
Batteries - Vdrive . . . . .	156
Batteries - Black Series . . . . .	157
Battery Powered Orthopaedic Drill . . . . .	161
Battery Powered Saw - Multisaw . . . . .	160
Battery Powered TPLO Saw . . . . .	159
Beaver Type Scalpel Blades . . . . .	180
Beaver Type Scalpel Handle . . . . .	180
Bending Levers . . . . .	40,139
Bending Templates . . . . .	103,140
Bennet's Cilia Forceps . . . . .	214
Bicortical Negative Threaded Pins . . . . .	145
BIOCERA-VET Bone Graft Products . . . . .	30
Biological Healing Plates . . . . .	99
Biopsy & Grasping Forceps - Malleable . . . . .	197
Biopsy & Spoon - Arthroscopic . . . . .	75
Biopsy Forceps - Soft Tissue . . . . .	196
Biopsy Needles - Bone/Bone Marrow . . . . .	28
Biopsy Needles - Soft Tissue . . . . .	207
Biopsy Punch - Skin . . . . .	208
BiPolar Cables . . . . .	235
BiPolar Dissecting Forceps . . . . .	234
BiPolar Units . . . . .	234
Bishop Harmon Forceps . . . . .	214
Bitch Speculum . . . . .	201
Black Series Power Tools . . . . .	157-158
Black Series Sterilisation Cases . . . . .	158,231
Blades - Acculan 4 . . . . .	155
Blades - Black Series . . . . .	158
Blades - Minidriver . . . . .	163
Blades - Multisaw . . . . .	160
Blades - TPLO . . . . .	37
Blades - Vdrive . . . . .	156
Blankets - Warm Air System . . . . .	238
Blood Pressure Cuffs . . . . .	239
Blunt Dissection Probe . . . . .	190
BOAS Mouth Gag . . . . .	195
BOAS Silicone Bar Sleeve . . . . .	195
BOAS Surgical Kit - Premium . . . . .	195
BOAS Surgical Kit - Standard . . . . .	195
Bone Cement . . . . .	78,173
Bone Curette . . . . .	172
Bone Cutters . . . . .	14
Bone Graft Products . . . . .	30-31
Bone Graft Products - BIOCERA-VET . . . . .	30

Bone Holding Forceps	9-10
Bone Lever	15
Bone Pin Roll	135
Bone Pin Tubes	135
Bone Plate Press	140
Bone Plate Retractor	141
Bone Punch Forceps - Low Profile	13,170
Bone Rasps	68,72-73
Bone Saws - Handheld	16,67
Bone Scribe	19
Bone Substitutes	30-31
Bone Trepine	19,28
Bone Tunnel Borers	59
Bone Wax	173
Bone/Bone Marrow Biopsy Needles	28
Boots	242-243
Bowel Clamps	203
Box Filters	229-230
Brushes for Surgical Instruments	232
Bulla Rongeurs	197
Bulldog Clamps	179
Bungee Gelpi	190
Bur Guards (for Power Tools)	164
Bur Stand	165
Bur System - High Speed - Surgairtome	164
Burs - Dental	223,226
Burs - Power Tools	165
Butterfly Plates	104
Buttons - Titanium	61

## C

C Drill Guide	138
Cage Forceps - TTA	46
Caliper - Vernier	19
Camera Covers - Disposable	75
Cancellous Chips	31
Cancellous Screws	126-127
Canine Ear Loop	197
Cannula Sets - Arthroscopic	75
Cannulated Drill Bits	132
Capnograph	239
Capsule Forceps	214
Carmault Hysterectomy Clamps	201
Carnivore Elevator	219
Carpal Arthrodesis Plates	105
Carpal Supports - Carpo-Flex	244
Carpo-Flex Carpal Supports	244
Castroviejo Corneal Forceps	214
Castroviejo Corneal Scissors	215
Castroviejo Needle Holder	185,212
Castroviejo Suture Removal Scissors	183
Cats Paw Retractor	64,187
Cautery Kit - Portable, Cordless	235
CBLO Implant Set	41
CBLO Plates	42
CBLO/TPLO Instrument Set	41
Cement Restrictor	77
CemtA Cups	77
CemtA Stems	77
Cerclage Button	141
Cerclage Wire	26,136

Cerclage Wire Passers	25
Chalazion Forceps (Desmarres)	216
Charger - Acculan 4	155
Charger - Battery Powered TPLO Saw	159
Charger - Black Series Drill and Saw	157
Charger - Vdrive	156
Chase Spinal Hook	172
Cheatle Steriliser Forceps	190
Cheek Dilators - Rodent	225
Chisels	18,219
Cilia Forceps	214
Clamps - External Fixation	146-147
Cleaning Agents for Surgical Instruments	232
Cleaning Brushes for Surgical Instruments	232
Clover Leaf T/TPLO-Plates	38,102
C-LOX Cervical Intervertebral Fusion - Implants & Equipment	168-169
Colibri (Barraquers) Forceps	214
Collins Retractor	188
Combi Canine Pantarsal Plates	107
Combi T-Plates	101
Combination Bone Rasp Set	72
Combination Drill, Tap & Insert Sleeve	138
Combined Screw Sets	85
Comfort Handle Elevators	218
Comfort Handle Winged Elevators	218
CompanionPort for Vascular Access	204
Compound Action Spinal Rongeurs	13,170
Compression Plates - Straight	93-95
Compression Plates - 1.0mm	89
Compression Plates - Limited Contact	95
Compression T-Plates	100
Condyle Clamp	111
Cone Laminectomy Retractor	171
Conjunctival Scissors	215
Connecting Bars - External Fixation	146-147
Connective Tissue Forceps	186
Corneal Forceps	214
Corneal Scissors	215
Corrective Osteotomy Sawguide System	68
Cortical Nuts	111,142
Cortical Plating Kit - 1.0mm	87
Cortical Plating Kits	85,87
Cortical Screw Sets	85
Cortical Screws - Non Self Tapping	118-119,121,123-125
Cortical Screws - Titanium	45
Cortical Screws - Self Tapping - 1.0mm	89
Cortical Screws - Self Tapping - Cruciate Drive	118-120
Cortical Screws - Self Tapping - Hex Drive	118-124
Cortical Screws - Self Tapping - Star Drive	118-122
Cortical Taps	129
Cosmetic Surgeon Scissors	182
Cotton Reusable Drapes	233
Countersinks	111,130
Couplands Elevator	219
Cozy Warm Air System	238
Criple Artery Forceps	178
Crimping Forceps - Lateral Suture	55,58
Crimps - Ligafiba	55
Crimps - Nylon	57
Crocodile Forceps	197
Cross Action Towel Clips	186
Crossley Incisor Luxator	225
Crossley Molar Luxator	226

Cruciate Drive Screwdrivers	128
Cruciate Needles	57
Cup Biopsy Forceps	196
Curette - Arthroscopic	74
Curette - Bone	172
Curette - Gracey Double Ended	221
Curette - House	172
Curette - OCD	72
Curette - Sheas	173
Curette - Subgingival	220
Curved Forceps - Long	198
Cuttable Cage Cutters - TTA	46
Cuttable Malleable Locking Plates	89,92,97
Cuttable Malleable Plates	97
Cuttable Plates	97
Cuttable Plates - 1.0mm	89
Cuttable TTA Cages	44
Cylindrical Sharpening Stone	226,232

## D

Dandy Nerve Hooks	172
Daniel Rongeur	13,169
Darvall AAS Warm Air System	238
Darvall Capnograph	239
Darvall Express Monitor	239
Darvall HI100N Pulse Oximeter & Temperature Monitor	240
DBM	31
DCPs	93-94
DCPs - Limited Contact	95
DeBakey Atraumatic Dissecting Forceps	187
DeBakey Needle Holders	184
Delta TPLO Plate Benders	40,139
Delta TPLO Plates	38
Demineralised Bone Matrix	31
Dental Burs	223,226
Dental Chart Labels	223
Dental Elevators	218-219
Dental Instrument Sharpening Tools	226,232
Dental Kits - Rabbit & Rodent	224
Dental Luxators	220
Dental Mirrors	222
Dental Scalars	220
Depth Gauge - TTA Rapid	49
Depth Gauge - TTA Rapid Petite	50
Depth Gauges	139
Derf Needle Holder	185,213
Desmarres Eyelid Retractor	213
Desmarres Forceps	216
DeSoutter Vdrive Power Tools	156
Diamond Card	226,232
Diamond Cone	226,232
Diamond Disc & Safety Shield	226
Diamond Rasp - Double Ended	225
Dieffenbach (Bulldog) Clamps	179
Dingmans Forceps	9
Disarticulator	73
Disposable Camera Covers	75
Disposable Drapes	233
Disposable Gowns	233
Disposable Padlocks	230
Disposable Tracheostomy Tubes	195

Dissecting Forceps	186-187
Distichiasis Clamp	216
Distractors - Orthopaedic	19
Divider Type TPLO Rotation Gauge	37
DLPs	90
DocXS Products	204-206
Dorsal Pantarsal Arthrodesis Plates	106
Dorsi-Flex Assist - Forelimb & Hindlimb	244
Double Ended Diamond Rasp	225
Double Ended Elevator	219
Double Nylon	56
Double-Ended Scraper	220
Doyen Bowel Clamp	203
DPO/TPLO Plates	69
Drapes - Cotton Reusable	233
Drapes - Disposable	233
Dressing Scissors	182-183
Drill & Screw Gauge	20
Drill Bits - 1.0mm Plating System	89
Drill Bits - Cannulated	132
Drill Bits - External Fixation	145
Drill Bits - Interlocking Nail System	84
Drill Bits - Isotoggle	61
Drill Bits - Quick Release/AO-Fit	131-132
Drill Bits - Round Shank	131-132
Drill Bits - TTA	45
Drill Bits - TTA Rapid	47
Drill Bits - TTA Rapid Petite	50
Drill Bits - TTA Rapid Tiny	51
Drill Guide - Adjustable	61,70,111,138
Drill Guide - TTA Rapid	49
Drill Guides & Sleeves	137-138
Drill Stop Set	132
Duck-Billed Daniel Rongeurs	13,169
Dynamic Compression Plates	93-94
Dynamic Compression Plates - Limited Contact	95
Dynamic Locking Plates	90
Dynamic Locking Plating Kits	85,87

## E

Ear Flushing Needles	208
Ear Loop	197
Ear Surgery	197
Elbow Arthrodesis Plates	108
Electrosurgery Units	234
Elevators - Dental	218-219
Elevators - Periosteal	15,219
Ellis Pins	144
End-Thread Pins	144-145
Enema Pump	207
Epilation Forceps	187,214
Epoxy ESF Putty	148
Equipment Box - ESF	148,231
Equipment Boxes	142,229-231
ESF Clamps	146-147
ESF Connecting Bars	146-147
ESF Equipment Box	148,231
ESF Pin Reference Chart	150-151
ESF Pins	144-145
ESF Tissue Protector	145
Excision Arthroplasty Rasp	73



Explorer/Measuring Probe . . . . .	220
External Fixation Clamps . . . . .	146-147
External Fixation Connecting Bars . . . . .	146-147
External Fixation Pin Reference Chart . . . . .	150-151
External Fixation Pins . . . . .	144-145
External Stifle Distractor . . . . .	74
Extraction Forceps - Dental . . . . .	221-222
Extraction Forceps - Pins and Wires . . . . .	24
Eye Enucleation Forceps . . . . .	216
Eye Enucleation Scissors . . . . .	215
Eyed Wires . . . . .	26,136
Eyelid Speculae . . . . .	213

## F

Fabella Needles . . . . .	57
Fat Pad Retractor . . . . .	64,187
Feeding Tube Collar . . . . .	207
Feline Elevator . . . . .	219
Femoral Head & Neck Excision Arthroplasty . . . . .	73
FESSA ESF System . . . . .	149
Filters for Boxes . . . . .	229-230
Fingered Silicone Insert . . . . .	230
Finochietto Rib Retractor . . . . .	188,198
FitzExcavator Set . . . . .	171
Fixation Forceps . . . . .	214
Fixed Shaft Screwdrivers . . . . .	128
Flushing Needles . . . . .	208
Foreign Body Retrieval Forceps . . . . .	199
Forelimb Dorsi-Flex Assist . . . . .	244
Forelimb Salvage Plates . . . . .	108
Forkless Plate Forceps - TTA . . . . .	46
Forkless TTA Plates . . . . .	44
Forkless TTA Starter Kit . . . . .	43
Forte Luxators . . . . .	220
Foster Gillies Needle Holder . . . . .	185
Foster Gillies Needle Holder - Miniature . . . . .	185,213
Fragment Forceps . . . . .	8,9
Fragment Forceps - Left Handed . . . . .	11
Fragment Forceps - Very Large . . . . .	40
Frazier Suction Tip . . . . .	236
Freer Periosteal Elevator . . . . .	15,172,219
Friedman Rongeurs . . . . .	12
Full Pins . . . . .	144

## G

Gag - BOAS . . . . .	195
Galibans Suture Forceps . . . . .	185
Gauge for Drills & Screws . . . . .	20
Gelpi Retractor - Odd Leg . . . . .	171
Gelpi Retractors . . . . .	66,171,189-190
General Surgery Kit . . . . .	176
General Surgery Kit - Left Handed Instruments . . . . .	176,191
Gigli Wire & Handles . . . . .	72
Gillies Needle Holders . . . . .	184
GIMA BiPolar Electrosurgery Units . . . . .	234
GIMA Smoke Evacuation Unit . . . . .	235
Goniometers . . . . .	72
Gordon Coronoid Osteotome . . . . .	67,75

Gosset Retractor . . . . .	188
Gouges . . . . .	18
Gowns - Disposable . . . . .	233
Gracey Double Ended Curette . . . . .	221
Graefe Fixation Forceps . . . . .	214
Graefe Iris Forceps . . . . .	214
Grasping & Biopsy Forceps - Malleable . . . . .	197
Grays Mouth Gag . . . . .	222

## H

Haemostatic Gel . . . . .	174,210
Haemostats . . . . .	178
Half Pins . . . . .	144
Halls Surgairtome Bur System . . . . .	164
Halstead Mosquito Forceps . . . . .	178
Halstead Mosquito Forceps - Toothed . . . . .	64
Hand Pressure Infusion Cuffs . . . . .	75
Handheld Retractors . . . . .	187-188
Handheld Saws . . . . .	16,67
Hanging Limb Prep Stand . . . . .	29
Hard Back Saw . . . . .	16,67
Hard Sole Medipaw Boots . . . . .	242
Hart Pinna Haematoma System (Implants Only) . . . . .	197
Hatt Spoons . . . . .	73
Hauptman Retractors . . . . .	201
Hawksbill Forceps . . . . .	221
Heated Anaesthetic Circuits . . . . .	239
Heath Stitch Scissors . . . . .	183
Heavy Duty Needle Driver . . . . .	59
Helica Total Hip Replacement (THR) . . . . .	76-78
Hepatic Shunt Occluder . . . . .	206
Hex Driver 'T' Bar Type for TPLO Saw . . . . .	159
Hex Head Screwdrivers . . . . .	128
High Speed Bur System - Surgairtome . . . . .	164
Hindlimb Dorsi-Flex Assist . . . . .	244
Hindlimb Salvage Plates . . . . .	108
Hip Fixation & Navigation Device - THR . . . . .	77
Hip Replacement Equipment & Implants . . . . .	76-78
Hip Toggling . . . . .	70
Hobdays Obstetric Forceps . . . . .	201
Hoe Periosteal . . . . .	220
Hoe Scaler . . . . .	220
Hohman Retractor - Arthroscopic . . . . .	75
Hohman Retractors . . . . .	71-72, 75-76
Hook Knife . . . . .	63
Hook Knife - Arthroscopic . . . . .	74
Hook Probe - Arthroscopic . . . . .	74
Horsley Bone Cutter . . . . .	14
Hose - Halls (for Surgairtome) . . . . .	164
Hose - Minidriver . . . . .	163
Hospivac (spares) . . . . .	236
House Curette . . . . .	172
Howard 'B' Ovariohysterectomy Clamp . . . . .	201
Howarth Dissector (Modified) . . . . .	15
HSO System . . . . .	206
Huber Needles . . . . .	206
Hybrid Anatomical T-Plates . . . . .	102
Hybrid T-Plates . . . . .	102
Hysterectomy Clamps - Carmault . . . . .	201

<b>I</b>	
Ikuta Bone Clamps	8
IM Pin Box	135
IM Pin Punch	16
IM Pins	134
Imperial Ruler	20
Implant Cutters	21-23, 145
Implant Selection Chart	88
Incise Drapes	233
Incisor Forceps	221
Incisor Luxator - Crossley	225
Infusion Cuffs - Arthroscopic	75
Infusion Needle - Interosseous	29,208
Insert Sleeves	137
Instrument Boxes	142,229-231
Instrument Cleaning Agents	232
Instrument Cleaning Brushes	232
Instrument Kit - Basic Surgery Stitch Up	176
Instrument Kit - General Surgery	176
Instrument Kit - Ophthalmic	212
Instrument Kits - BOAS Surgery	195
Instrument Kits - Left Handed	176,191
Instrument Kits - Rabbit & Rodent Dentistry	224
Instrument Marking Tape	232
Instrument Trays - Modular Plating Box	86,228
Interference Screw - Isotoggle	61
Interlocking Nail System - Drill Bits	84
Interlocking Nail System - Instrument & Implant Sets	81
Interlocking Nail System - Locking Screws & Bolts	83
Interlocking Nail System - Nails	82
Interlocking Nail System (ILN)	81-84
Interosseous Infusion Needle	29,208
Intervertebral Instrument Set	171
Intra-Medullary Pins	134
Iodine-Impregnated Drapes	233
Iris Forceps	214
Iris Scissors	215
Isotoggle	61
Isotoggle Drill Bits	61
Isotoggle Interference Screw	61

<b>J</b>	
Jacobs Chuck - Handheld	25
Jaeger Eyelid Speculum	213
Jamshidi Biopsy Needles	28,208
Jansen Rongeurs	12
Jaquette Scaler	173
Jaquette Supragingival Scaler	220
Jigs - TPLO	39
Joint Distractors	65
Jones Towel Clip	186

<b>K</b>	
K Wires	133
K Wires - TTA Rapid	47
K/A Wire Bender	16
K/A Wire Dispenser	135

K/A Wire Extraction Forceps	24
K/A Wire Holders	135
K/A Wire/Pin Punches	16
K110 Small Jacobs Chuck (Minidriver)	162
K111 Wire Driver (Minidriver)	162
K211 Pin Driver (Minidriver)	162
KE Plus ESF System	147
Kelly Forceps	178
Kennel Liner - Washable	233
Kern Bone Holding Forceps	10
Killian Bitch Speculum	201
Kilner Needle Holders	185
Kimura Spatula	216
Kirschner Wires	133
Kitty Kollar Tube Collar	207
Kocher Artery Forceps	178

<b>L</b>	
L/R Xray Marker With Scale	20
Labels for Premium Instrument Boxes	229
Lachrymal Cannulae	216
Laminectomy Rongeurs	170
Langenbeck Retractor	187
Large Angled Cutters	14
Large Twin Point Reduction Forceps (Spinlock)	9
Lateral Button Suture	60-61
Lateral Suture	54-59
Lateral Suture - Crimping Forceps	55,58
Lateral Suture - Ligafiba	55
Lateral Suture - Nylon	56-57
Lateral Suture - Tensioning Devices	58
Lateral Suture Starter Kits	54
Leader Line	56-57
LED Light for Table Top Rabbit Gag	224
Left Handed Instruments	11,176-177,191-192
Left Handed Instruments - General Surgery Kit	176,191
Left Handed Instruments - Spay Kits	177
Left Handed Instruments - Starter Kit	176,191
LeiLOX 1.5/2.0 MicroLocking System	109-110
LeiLOX CBLO Locking System	41,42
LeiLOX Instrumentation for Locking Plates	109-110
LeiLOX Locking Screws	42
LeiLOX Locking Screws	109-110
LeiLOX Non-Locking Screws	42
LeiLOX Screwdriver	42,110
Lempert Straight Rongeurs	12,170
Lesser Wire Passer/Retrieval Forceps	25
Lever Spreader - TTA Rapid	49
Ligafiba - Hip Toggles	70
Ligafiba - Lateral Button Suture	60
Ligafiba Compound Action Crimpers	55
Ligafiba Isotoggle	61
Ligafiba Lateral Suture	55
Ligafiba Scissors	55,59
Ligafiba Tendon & Ligament Sutures	62
Ligament/Cartilage Clamp	64
Light Pattern Chisel	18
Light Pattern Osteotome	17
Limb Salvage Plates	108
Limb Support - Multi Arm	29
Limited Contact Compression Plates	95

Lip Retractor	222
Lister Bandage Scissors	183
Lister Speculum	213
Liston Bone Cutters	14
Littauer Stitch Scissors	183
Load Neutral Drill Guides	137
Locking Drill Guides	69,137
Locking Plates - Cuttable Malleable	89,92,97
Locking Plates - Dynamic Locking	90
Locking Plates - Pancarpal Arthrodesis	105
Locking Plates - Stacked Hole	91
Locking Plates - Supracondylar	103
Locking Plates - T-Plates	100
Locking Plates - TPLO	37
Locking Plates (LeiLOX)	109-110
Locking Plating Kits	85,87
Locking Plugs	117
Locking Screw Drill Guides	69,137
Locking Screw Drill Guides - Extra Long	69
Locking Screw Sets	85,87,117
Locking Screws	116-117
Locking Screws (LeiLOX)	42
Locking Screws (LeiLOX)	109-110
Locking Taps	129
Locking TPLO Starter Kits	35,36
Locking Wire Guide	137
LokRod Plates	92
Lowman Bone Clamp	10
L-Shaped Saw Guide - TTA Rapid	48, 50-51
Luxators - Dental	220
Lyostypt	173,210

## M

Malleable (Walton) Retractors	188
Malleable Grasping & Biopsy Forceps	197
Malleable Instrument Set	197
Malleable Orthopaedic Wire	26,136
Mallet - Percussion	169
Mallet - TTA	46
Mallet - Orthopaedic	18
Mayo Hegar Needle Holders	184
Mayo Needle Holders	184
Mayo Safety Pin	179
Mayo Scissors	181-182
McIndoe Bone Cutters	14
McKee Distractor	171
McPhails Needle Holders	184
Medial Pantarsal Arthrodesis Plates	106-107
Medipaw Protective Boots	242-243
Medipaw Protective Suits	243
Medipaw Slim Boots	243
Meniscectomy Knife	63
Meniscus Probes	63
Meniscus Surgery Instruments	62-64
Meniscus Surgery Kits	62
Mesh - Polyester	207
Mesh - Titanium	111
Metric Ruler	20
Metzenbaum Scissors	181-182
Micro Friedman Rongeurs	12,170
Micro Scissors	195

Micro Spine Rongeur Set	13,169
Mid-Thread Pins	144
Milling Drill - Hand-Driven	75
Mini Friedman Rongeurs	12,170
Miniature Foster Gillies Needle Holder	185,213
Minidriver & Attachments	162-163
MIPO Minimally Invasive Plate Osteosynthesis Elevator	15
Miss Freakes Whelping Forceps	201
Modular Countersinks	130
Modular Osteotome	17,67
Modular Plating Box - Components	86,228
Modular Plating Box Kits	85
Modular Screwdrivers	128
Molar Cutter - Rodent	225
Molar Extraction Forceps	226
Molar Luxator - Crossley	226
Molar Rasp - Rodent	225
Molt Periosteal Elevator	15,219
Monitors	239-240
Monopolar Electrodes	235
Monopolar Handles	235
Monopolar Unit	234
Morris Retractor	187
Mosquito Forceps	178
Mouth Gag - BOAS	195
Mouth Gags - Rodent/Rabbit	225
Mouth Gags & Wedges - Canine/Feline	222
Multi Arm With Limb Brace Attachment	29
Multi Saw Battery Powered Saw	160
Multiparameter Monitor	239

## N

Nanopaste	31
Nasolachrymal Duct Cannulae	216
Needle Boxes	231
Needle Holders	184-185, 212-213
Needle Holders - Left Handed	192
Needles - Biopsy	28,207
Needles - Ear Flushing	208
Needles - Flushing	208
Needles - Oral Dosing	208
Needles - Spinal	173
Needles - Spruells	208
Negative Pressure Wound Therapy	209
Negus Forceps	178,196
Non-Locking Screws (LeiLOX)	42
Norfolk Vet Products	204-206
Nylon - Lateral Button Suture	61
Nylon Lateral Suture	56-57

## O

Obstetric Forceps	201
OCD Curette	72
Odd Leg Gelpi Retractor	171
Odd Leg Spike & Shield Retractor	171
Oesophagostomy Tube Collar	207
Offset Wire Bender	16
Olsen Hegar Needle Holders	184

Ophthalmic Kit . . . . .	212
Oral Dosing Needles . . . . .	208
Orthopaedic Distractor . . . . .	19
Orthopaedic Drill - Battery Powered . . . . .	161
Orthopaedic Hard Back Saw . . . . .	16,67
Orthopaedic Mallets . . . . .	18
Orthopaedic Starter Kit - Enhanced . . . . .	7
Orthopaedic Starter Kit - Standard . . . . .	6
Orthopaedic Wire . . . . .	26,136
Orthopaedic Wire Kit . . . . .	26,136
Osteophyte Rasp . . . . .	68
Osteotome - Gordon Coronoid . . . . .	67
Osteotomes . . . . .	17,67
Ovariohysterectomy . . . . .	200-201
Ovariohysterectomy Clamp - Howard 'B' . . . . .	201

## P

Padded Splints . . . . .	244
Padlocks - Disposable . . . . .	230
Pancarpal Arthrodesis Plates - DCP Style . . . . .	105
Pancarpal Arthrodesis Plates - Locking . . . . .	105
Pantarsal Arthrodesis Plates . . . . .	106-107
Parallel Action Pliers . . . . .	24
Partial Carpal Arthrodesis Plates . . . . .	105
Partial Tarsal Arthrodesis Plates . . . . .	106
Patella Saw . . . . .	16,67
Patellar Luxation Instrumentation . . . . .	67-68
Patellar Luxation Plate - Titanium . . . . .	52
Patient Monitoring . . . . .	239-240
Patient Warming . . . . .	238-239
Penrose Drains . . . . .	207
Percussion Mallet . . . . .	169
Periodontal Instruments . . . . .	220
Periosteal Elevators . . . . .	15,172,219
Periotome - Hoe . . . . .	220
Petite TTA Rapid . . . . .	50
Pin & Wire Extraction . . . . .	24
Pin & Wire Storage . . . . .	135
Pin Benders . . . . .	16
Pin Cutters . . . . .	21-23, 145
Pin Grip . . . . .	24
Pin Punches . . . . .	16
Pin Reference Chart . . . . .	150-151
Pin Vice . . . . .	24
Pinna Haematoma System (Implants Only) . . . . .	197
Pins - External Fixation . . . . .	144-145
Pins & Wires . . . . .	133-135
Pipcleaners . . . . .	232
Plaster Cutting . . . . .	27
Plaster Shears Stille . . . . .	27
Plaster Spreaders . . . . .	27
Plate Benders - Delta . . . . .	40
Plate Bending Levers . . . . .	139
Plate Bending Pliers . . . . .	139-140
Plate Contouring Devices . . . . .	139-140
Plate Holding Clip . . . . .	141
Plate Holding Forceps . . . . .	11
Plate Holding/Drill Guide Forceps . . . . .	10,40,49
Plate Pliers . . . . .	139-140
Plate Press . . . . .	140
Plate Retractor . . . . .	141

Plate Selection Chart . . . . .	88
Plate Trays - Modular Plating Box . . . . .	86,228
Plating Kit - 1.0mm . . . . .	87
Plating Kits - Cortical . . . . .	85,87
Plating Kits - Cortical - Limited Contact . . . . .	87
Plating Kits - Locking . . . . .	85,87
Pleural Port . . . . .	204
Pliers - Parallel Action . . . . .	24
Pliers - Plate Bending . . . . .	139-140
Pointed Reduction Forceps . . . . .	8
Polyester Mesh . . . . .	207
Poole Suction Tip . . . . .	236
Pooley's Conjunctival Scissors . . . . .	215
Portable Cordless Cautery Kit . . . . .	235
Power Tool Lubricants . . . . .	155,164
Pre-Drills for ESF Pins . . . . .	132,145
Premium Depth Gauges . . . . .	139
Premium Instrument Boxes . . . . .	229
Premium TTA Case . . . . .	43
Protective Autoclavable Tips . . . . .	233
Protective Boots . . . . .	242-243
Protective Suits . . . . .	243
Protractor for TPLO Blades . . . . .	159
Puddle Vac . . . . .	75
Pulse Oximeter & Temperature Monitor . . . . .	240
Punch Forceps . . . . .	13,170
Punctum Dilator . . . . .	216
Push Knife . . . . .	63

## Q

Quick Release Handles . . . . .	128-130
Quick Release/AO-Fit Drill Bits . . . . .	131-132

## R

Rabbit & Rodent Dental Kits . . . . .	224
Rabbit Gag . . . . .	224
Rabbit Nasolachrymal Duct Cannulae . . . . .	216
Rabbit/Rodent Bur Kit . . . . .	226
Radiographic L/R Marker With Scale . . . . .	20
Radiographic Reference Ball . . . . .	20
Ramplays Sponge Forceps . . . . .	179
Rapid Luxation Plating System . . . . .	52
Rapidex . . . . .	232
Rapizyme . . . . .	232
Rasp - Combination Bone Rasp . . . . .	72
Rasp - Excision Arthroplasty . . . . .	73
Rasp - Osteophyte . . . . .	68
Rasps - Dental . . . . .	225
Rasps - Orthopaedic . . . . .	68,72-73
Rasps - Patellar Luxation . . . . .	68
Rat Tooth Forceps . . . . .	186
Reconstruction Plate Pliers . . . . .	139
Reconstruction Plates . . . . .	99
Rectangular Sulcoplasty Instruments . . . . .	68
Reduction Forceps . . . . .	8-9,49
Resano Bowel Clamp . . . . .	203
Retractor - TECA . . . . .	197
Retractors - Abdominal . . . . .	188

Retractors - Gelpi . . . . .	66,171,189-190
Retractors - Skin/Superficial . . . . .	189
Rib Retractor - Finochietto . . . . .	188,198
Right Angled Clamps . . . . .	198
Ring Curette - Arthroscopic . . . . .	74
Ring Retractor . . . . .	188,202
Roberts Tying Forceps . . . . .	213
Rochester Pean Artery Forceps . . . . .	178
Rodent Cheek Dilators . . . . .	225
Rodent Molar Cutter . . . . .	225
Rodent Molar Rasp . . . . .	225
Rodent Mouth Gags . . . . .	225
Rodent Spatula . . . . .	225
Rodent/Rabbit Bur Kit . . . . .	226
Rongeur & Grasping Forceps - Arthroscopic . . . . .	75
Rongeurs . . . . .	12-13, 66, 169-170, 197
Root Fragment Set . . . . .	222
Root Tip Extraction Forceps . . . . .	226
Rosen Mobiliser . . . . .	172
Rosenthal Biopsy Needle . . . . .	28
Rotation Chart - TPLO . . . . .	40
Round Hole Plates . . . . .	98
Round Hole T-Plates . . . . .	102
Round Shank Drill Bits . . . . .	131-132
Rulers . . . . .	20
Ruskin Bone Cutters . . . . .	14
Ruskin Rongeurs . . . . .	12
Ryder Needle Holders . . . . .	185,213

## S

Safety Implant/Pin Cutter . . . . .	145
Satinsky Clamp . . . . .	196
Saw Blades - TPLO . . . . .	37
Saw Guide - TTA . . . . .	46
Saws - Handheld . . . . .	16,67
Scalers - Handheld . . . . .	220
Scalpel Blade Removers . . . . .	180
Scalpel Blades & Handles . . . . .	180
Schroeder Tenaculum . . . . .	9
Scissors - Dressing . . . . .	182-183
Scissors - General Surgical . . . . .	181-183
Scissors - Left Handed . . . . .	191
Scissors - Ligafiba . . . . .	55
Scissors - Micro . . . . .	195
Scissors - Ophthalmic . . . . .	215
SCOP Plates . . . . .	103
Scratch Pad . . . . .	235
Screw & Screwdriver Identification Aids . . . . .	112-115
Screw Box for Titanium TTA Screws . . . . .	45
Screw Boxes . . . . .	86,228,231
Screw Caddies - Modular Plating Box . . . . .	86,228
Screw Extraction Trepphine . . . . .	142
Screw Holding Forceps . . . . .	141
Screw Identification Resources . . . . .	112-115
Screw Sets - Combined . . . . .	85
Screw Sets - Cortical . . . . .	85
Screw Sets - Locking . . . . .	85,87,117
Screwdriver - TTA Rapid Petite . . . . .	50
Screwdriver - TTA Rapid Tiny . . . . .	51
Screwdriver & Screw Identification Aids . . . . .	112-115
Screwdriver (LeiLOX) . . . . .	42
Screwdriver Inserts - TTA Rapid . . . . .	49
Screwdrivers - Fixed Shaft . . . . .	128
Screwdrivers - Modular . . . . .	128
Screws - Cancellous . . . . .	126-127
Screws - Cortical Non Self Tapping . . . . .	118-119,121,123-125
Screws - Cortical Self Tapping - Cruciate Drive . . . . .	118-120
Screws - Cortical Self Tapping - Hex Drive . . . . .	118-124
Screws - Cortical Self Tapping - Star Drive . . . . .	118-122
Screws - Locking . . . . .	116,117
Self Centering Bone Holding Forceps . . . . .	10
Self-Centring Drill Guides . . . . .	138
Senn (Cats Paw) Retractor . . . . .	64,187
Serrated Block End Dissecting Forceps . . . . .	186
Shaft Screws . . . . .	111
Shardel Towel Clip . . . . .	186
Sharpening Stone . . . . .	226,232
Sharpening Tools for Dental Instruments . . . . .	226,232
Sheas Curette . . . . .	173
Shepherd's Crook Explorer Probe . . . . .	220
Shoulder Aiming Device - Arthroscopic . . . . .	75
Shroud - Multisaw . . . . .	160
Shroud - Orthopaedic Drill . . . . .	161
Silicone Insert . . . . .	230
Skin Biopsy Punch . . . . .	208
Skin Marker . . . . .	190
Skin Staple Remover . . . . .	209,233
Skin Staplers . . . . .	209,233
Slocum Rotation Gauges . . . . .	37
Slocum Style TPLO Plates . . . . .	38
Small Angled Cutters . . . . .	14
Small Bar Set for BOAS Mouth Gag . . . . .	195
Small Curved Rongeurs . . . . .	12
Small Curved Serrated Reduction Forceps . . . . .	9
Small Distractor With Ratchet . . . . .	19
Small Pin Punch . . . . .	16
Small Pin Vice . . . . .	24
Small Serrated Bone Holding Forceps . . . . .	9
Small Stifle Rongeurs . . . . .	66
Smilie Knife - Arthroscopic . . . . .	74
Smith Baxter Mouth Gag . . . . .	222
Smith-Kerrison Punch Forceps . . . . .	13,170
Smoke Evacuation Unit . . . . .	235
Snellen's Vectis . . . . .	216
Soft Edge Surgical Spoon . . . . .	203
Soft Palate Clamp . . . . .	196
Soft Sole Medipaw Boots . . . . .	242
Soft Tissue Biopsy Forceps . . . . .	196
Soft Tissue Biopsy Needles . . . . .	207
Spacers - TTA . . . . .	45
Spanners . . . . .	148
Spatula - Ophthalmic . . . . .	216
Spatula - Rodent . . . . .	225
Spay Forceps . . . . .	200
Spay Hooks . . . . .	200
Spay Kit - Canine . . . . .	200
Spay Kit - Feline . . . . .	200
Spay Kits - Left Handed Instruments . . . . .	177
Spay Surgery . . . . .	200-201
Speculae - Eyelid . . . . .	213
Speculae - Obstetric . . . . .	201
Spencer Wells Artery Forceps . . . . .	178
Spike & Shield Odd Leg Retractor . . . . .	171
Spikey Washers . . . . .	141
Spinal Distractors . . . . .	171

Spinal Needles . . . . .	173	Surgical Scissors . . . . .	181-183
Spinal Rongeurs . . . . .	13,170	Surgical Skin Marker . . . . .	190
Spinal Rongeurs - Compound Action . . . . .	13,170	Surgical Spoon - Soft Edge . . . . .	203
Splints - Padded & Thermoplastic . . . . .	244	Surg'X Instrument & Implant Sets . . . . .	81
Sponge Forceps . . . . .	179	Surg'X Interlocking Nail System (ILN) . . . . .	81-84
Spreulls Needles . . . . .	208	Suture Anchor Pins . . . . .	62
St Martins Corneal Forceps . . . . .	214	Suture Screws . . . . .	62
St Martins Dissecting Forceps . . . . .	187	Swann Morton Scalpel Blades . . . . .	180
Stacked Hole Locking Plates . . . . .	91	Swann Morton Scalpel Handles . . . . .	180
Standard Fixator ESF System . . . . .	146	Swedish Pattern Chisel . . . . .	18
Staples - Skin . . . . .	209,233	Swedish Pattern Osteotome . . . . .	17
Star Drive Screwdrivers . . . . .	128		
Starter Kit - Canine Spay . . . . .	200	<b>T</b>	
Starter Kit - Feline Spay . . . . .	200	T Bar Countersinks . . . . .	130
Starter Kit - Heated Anaesthetic Circuits . . . . .	239	T Bar Taps . . . . .	129
Starter Kit - Left Handed Instruments . . . . .	176,191	Table Top Rabbit Gag . . . . .	224
Starter Kit - Ophthalmic . . . . .	212	Table Top Stand For Hanging Limb Prep . . . . .	29
Starter Kit - Orthopaedic - Enhanced . . . . .	7	Tap Devices . . . . .	129
Starter Kit - Orthopaedic - Standard . . . . .	6	Tarsal Arthrodesis Plates . . . . .	106-107
Starter Kit - Thoracic Surgery . . . . .	198	Tarsal Supports - Tarso-Flex X . . . . .	244
Starter Kit - TTA (Forkless) . . . . .	43	Tarso-Flex X Tarsal Supports . . . . .	244
Starter Kit - TTA (Standard) . . . . .	43	Tartar Forceps . . . . .	221
Starter Kit - TTA Rapid . . . . .	47	Tartar Scrapers . . . . .	220-221
Starter Kit - TTA Rapid Tiny . . . . .	51	TECA Retractor . . . . .	197
Starter Kit - Warm Air Unit . . . . .	238	Temno Evolution Biopsy Needle . . . . .	207
Starter Kits - BOAS Surgery . . . . .	195	Temperature Monitor & Pulse Oximeter . . . . .	240
Starter Kits - Lateral Button Suture . . . . .	60	Tendon & Ligament Sutures - Ligafiba . . . . .	62
Starter Kits - Lateral Suture . . . . .	54	Tenotomy Scissors . . . . .	215
Starter Kits - Ligafiba Lateral Button Suture . . . . .	60	Tensioning Devices - Lateral Suture . . . . .	58
Starter Kits - Locking TPLO . . . . .	35-36	Tetra-EDTA Flush . . . . .	206
Starter Kits - Rabbit & Rodent Dentistry . . . . .	224	T-FloLoc . . . . .	206
Starter Kits - TPLO . . . . .	35-36	Thera-Paw Boots . . . . .	242
Steinman Intra-Medullary Pins . . . . .	134	Thermoplastic Splinting . . . . .	244
Sterile Hooks . . . . .	188,202	Thoracic Surgery . . . . .	198-199
Sterile Skin Marker . . . . .	190	Thoracic Surgery Kit . . . . .	198
Sterilisation Cases - Black Series . . . . .	158,231	THR . . . . .	76-78
Steven's Tenotomy Scissors . . . . .	215	Threaded Pins & Wires . . . . .	134
Stifle Distractor - External . . . . .	74	Tibial Tappet - TTA Rapid . . . . .	52
Stifle Distractors . . . . .	65	Tiny TTA Rapid . . . . .	51
Stifle Levers . . . . .	63,74	Tiny TTA Rapid Cages . . . . .	51
Stille Plaster Shears . . . . .	27	Tiny TTA Rapid Drill Bits . . . . .	51
Stille-Luer Rongeurs . . . . .	12,170	Tissue Forceps . . . . .	179
Stitch Scissors . . . . .	183	Tissue Protection Sleeves . . . . .	137
Stitch Up Kit . . . . .	176	Tissue Protector - ESF . . . . .	145
Stomach Tubes . . . . .	209	Titanium Buttons . . . . .	61
Strabismus Scissors . . . . .	215	Titanium Buttons . . . . .	70
Strong Cerclage Wire Passers . . . . .	25	Titanium Cortical Screws (TTA Rapid) . . . . .	48,50-51
Stubby Osteotome . . . . .	17	Titanium Cortical Screws (TTA) . . . . .	45
Stubby Punch . . . . .	16	Titanium Mesh System . . . . .	111
SUB Flush Kit . . . . .	206	Tongue Forceps - Youngs . . . . .	179
SUB System . . . . .	205	Tonsillectomy Clamp . . . . .	196
Subcutaneous Ureteral ByPass System . . . . .	205	Toothed Halstead Mosquito Forceps . . . . .	64
Subcutaneous Ureteral ByPass System - Flush Kit . . . . .	206	Total Hip Replacement . . . . .	76-78
Subgingival Curette . . . . .	220	Towel Clips . . . . .	186
Suction Machine . . . . .	236	T-Plates - 1.0mm . . . . .	89
Suction Tips . . . . .	236	T-Plates - Clover Leaf . . . . .	38,102
Suction Tubing & Connectors . . . . .	236	T-Plates - Combi . . . . .	101
Superfine Elevator . . . . .	219	T-Plates - Compression . . . . .	100
Supracondylar Locking Plates . . . . .	103	T-Plates - Hybrid . . . . .	102
Supracondylar Osteotomy Plates (SCOP) . . . . .	103	T-Plates - Hybrid Anatomical . . . . .	102
Supracondylar Plates . . . . .	103	T-Plates - Locking . . . . .	100
Supragingival Scaler - Jaquette . . . . .	220		
Surgairtome Bur System . . . . .	164		
Surgery Kits - Meniscus . . . . .	62		

T-Plates - Round Hole	102
TPLO - Starter Kits	35-36
TPLO Guide Pins	37
TPLO Instrument Trays - Modular Plating Box	86,228
TPLO Jigs	39
TPLO Plates	37-38
TPLO Reduction Forceps With Wire Guide	40
TPLO Rotation Chart	40
TPLO Rotation Gauge (Divider Type)	39
TPLO Rotation Gauges	39
TPLO Saw Blade Protractor	39
TPLO Saw Blade Protractor	159
TPLO Saw Blades	37
TPLO Saw Hex Driver 'T' Bar Type	159
TPLO Saws	155-156, 159
TPLO Starter Kits - Locking	35-36
TPLO/CBLO Instrument Set	41
TPO/DPO Plates	69
Tracheostomy Tubes - Disposable	195
Travers Retractor	189
Trepine - Bone	19,28
Trepine - Screw Extraction	142
Treves Rat Tooth Forceps	186
Triple Drill Guides	138
Triple Tibial Osteotomy - Plates & Equipment	53
Trochlea Rasp	68
Tru-Cut Biopsy Needles	207
TTA - Drill Bits	45
TTA Cage Forceps	46
TTA Cages	44
TTA Case - Premium	43
TTA Cuttable Cage Cutters	46
TTA Cuttable Cages	44
TTA Forkless Plate Forceps	46
TTA Forks	44
TTA Instrumentation	46
TTA Mallet	46
TTA Plates (Forkless)	44
TTA Plates (Standard)	44
TTA Rapid 1.5mm Titanium Screws - Tiny - Star Drive	51
TTA Rapid 2.0mm Titanium Screws - Petite - Hex Head	50
TTA Rapid 2.0mm Titanium Screws - Tiny/Petite - Star Drive	51
TTA Rapid 2.4mm Titanium Screws - Hex Head	48
TTA Rapid Acetate	48
TTA Rapid Bending Iron	48
TTA Rapid Cages - Petite	50
TTA Rapid Cages - Standard	48
TTA Rapid Cages - Tiny	51
TTA Rapid Depth Gauge	49
TTA Rapid Drill Bits	47
TTA Rapid Drill Guide	49
TTA Rapid Implant Tray	47
TTA Rapid Instrument Tray	47
TTA Rapid K Wires	47
TTA Rapid Lever Spreader	49
TTA Rapid L-Shaped Saw Guide	48
TTA Rapid L-Shaped Saw Guide - Petite	50
TTA Rapid L-Shaped Saw Guide - Tiny	51
TTA Rapid Luxation Plating System	52
TTA Rapid Patellar Luxation Spacers	52
TTA Rapid Petite	50
TTA Rapid Petite Depth Gauge	50
TTA Rapid Petite Screwdriver	50
TTA Rapid Petite Twist Drill	50

TTA Rapid Plate Holding Forceps	49
TTA Rapid Saw Guide Pin	48
TTA Rapid Screwdriver Inserts	49
TTA Rapid Spreader - Tiny	50
TTA Rapid Starter Kit	47
TTA Rapid Tibial Tappet	52
TTA Rapid Tiny	51
TTA Rapid Tiny Starter Kit	51
TTA Rapid Universal Spreader	49
TTA Saw Guide	46
TTA Screwbox	45
TTA Screws	45
TTA Spacers	45
TTA Spinlock Reduction Forceps	46
TTA Starter Kits	43
TTA Washers	45
TTO - Plates & Equipment	53
Twin Point Fragment Forceps	8
Tying Forceps - Roberts	213

## U

Universal Drill Guides	137
Universal Spreader - TTA Rapid	49
Universal Sulcoplasty Rasp	68

## V

V.A.C. Therapy Unit	209
Variable Speed Orthopaedic Drill	161
Vascular Access - CompanionPort	204
Vascular Probe Set	202
Vdrive Power Tools	156
Vernier Caliper	19
Veterinary Tissue Bank Products	31
Vetigel & Vetigel Accessory Packs	174,210
VILTPO Locking TPLO Plates	37
Volkman Bone Scoop	18
Volkman Bone Scoop	18
VSTL Stifle Lever	63,74

## W

Walton Retractors	188
Warm Air System - Unit & Blankets	238
Washable Kennel Liner	233
Washers	141
Washers - TTA	45
Waterproof Shroud - Multisaw	160
Waterproof Shroud - Orthopaedic Drill	161
Webb Bolts	141
Wedge Elevator	219
Wedge Osteotomy Gauge Set	40
Weislander Retractor	189
West Retractor	189
Whelping Forceps	201
Whiting Bone Plate Retractor	141
Winged Director	190
Winged Elevators	218

Wire & Pin Extraction . . . . .	24
Wire & Pin Storage. . . . .	135
Wire Benders . . . . .	16
Wire Contouring Pliers . . . . .	24
Wire Kit . . . . .	26,136
Wire Passer/Retrieval Forceps. . . . .	25
Wire Passers. . . . .	25
Wire Tighteners . . . . .	26,136
Wire Twister/Shear Cutter. . . . .	26,136
Wires & Pins . . . . .	133-135
Wires with Eyelet . . . . .	26,136
Wound Therapy - Negative Pressure . . . . .	209

## X

Xray Marker With Scale . . . . .	20
----------------------------------	----

## Y

Yankauer Suction Tip. . . . .	236
Younger Good Scaler . . . . .	173
Youngs Tongue Forceps. . . . .	179









**Veterinary**  
Instrumentation

## The Vi BOAS Mouth Gag

Designed to simplify surgical access during BOAS Surgery



View the full range on Page 193

## Veterinary Instrumentation

Distinction House, 26 Atlas Way, Sheffield, UK, S4 7QQ

+44 (0)114 258 8530

info@vetinst.com

www.vetinst.com



@Veterinary Instrumentation



CATUK2024